

CABLING SYSTEM WAREHOUSE

2010 Edition



800-488-8821

www.cablingsys.com

	Page Number
Digital Signage - HDMI	01-02
Digital Signage - DVI	03-04
Digital Signage - VGA	05-09
Digital Signage - DisplayPort	09
Digital Signage - Mini DisplayPort	10
Digital Signage - USB	10
Digital Signage - Audio/Video	11
Digital Signage - KVM	12
Digital Signage - RS-232	12
Fiber Optics Cabling	13-17
MTP/MPO Fiber Optics Structure Cabling	18-20
Multimedia Snap-in Module	21
Cat 6a Cabling	22-23
Cat 6 Cabling	24-27
Cat 5e Cabling	28-30
Bulk Cables	31
25-Pair Cabling	32
STP - Shielded Twisted Pair Cabling	33
General UTP Cabling	34-35
RS-232 UTP Cabling	36
Racks and Shelves	37
Tools	38-39
HomeVue - Home Wiring	40
Audio/Video Cables	41
Audio/Video Structure Cabling System	42-44
Audio/Video Easy Integrated Solutions	45-46
Coaxial Cables	47
Video Cables	48
FireWire Cables	48
DVI Cables	49
PC Cables	49
PC Cables & Accessories	50-51
PC Accessories	52
USB Cables & Accessories	53
USB/FireWire Adapters & Panels	54
Video Balun and A/V Adapters	55
SCSI Cables	56-57
CX4 Infiniband Cables	57
Cisco Cables & OEM Cables	57

NEW PRODUCTS



Telephone:
(800)488-8821 or (909)468-9211
8:30 am to 5:30 pm Pacific Time, Monday thru Friday.

Fax:
(909)468-9701 - Fax line open 24 hours a day, 7 days a week.

Mail:
Mail your order to:
Cabling System Warehouse
20418 E. Walnut Dr. Unit 1A,
Diamond Bar, CA 91789

E-mail:
Send order to sales@cablingsys.com

On-line:
Order from www.cablingsys.com

Minimum Order:
\$50.00 merchandise subtotal.
\$5.00 surcharge will apply if less than \$50.00.

Method of Payment: American Express, Discover, Mastercard, Visa, or Net 30 to qualified institutions.

F.O.B.:
Diamond Bar, California. Freight will be prepaid and added to the invoice.

Sales Tax:
Applicable to California users only. CA Resellers must provide valid resale certificate.

Return Policy:

- All returns should be made within 30 days of date of invoice and are accompanied by the original invoice number, an RMA number and a brief explanation of the reason of the return. Please contact a customer service representative to obtain a return authorization (RMA) number. An RMA number is only good for 30 days.
- Return merchandise in original packaging and in resaleable condition. Parts returned due to customer error is subject to 25% of returned merchandise or \$5.00 restocking charge, whichever is greater.
- No cash refund. Store credit only.
- "Special Order Items" are not returnable.

Prices and products are subject to change without notice. Go to www.cablingsys.com for the most updated information. Not responsible for printing and/or typographical errors.

© 2010 Cabling System Warehouse. All rights reserved. Printed in USA. All products and names used throughout this catalog are trademarks of their respective holders.



SYSTIMAX®



LIFETIME WARRANTY

To ensure our customer's best interest, CSW's systems are covered by a Lifetime Warranty on parts and performance when installed as part of a CSW Certified Cabling System. A CSW "Certified Cabling System" will effectively carry the signals of any communication equipment developed and sactioned for use with the category of UTP cable originally installed, including ATM, 10 Base-T, 100 Base-TX, Gigabit Ethernet, and Token Ring.

FLUKE DSP-4300 TESTING

Connectivity components are chosen to simulate a channel environment, testing is performed with a FLUKE Networks DSP-4300. All individual components must pass accepted industry standards of the specified channel to qualify for our certification, within Category 5, Category 5E or Category 6 guidelines. Testing results are documented and are available upon request.



LINKWARE
CABLE TEST MANAGEMENT SOFTWARE

Cable ID: BELDEN 1700A CAT5E

Date / Time: 01/13/2009 12:58:21pm
Headroom: 8.0 dB (NEXT 36.7%)
Test Limit: TIA Clc 2 in Patch Cord
Cable Type: UTP 100 Ohm Cat 5e
Fault Anomaly Threshold: 15%

Operator: RICKY CHENG
Software Version: 1.912
Links Version: 5.13C
MPL: 68.0%

Shield Test: N/A

Module: DSP-4300
Main SN: 8529003
Remote SN: 8529003
Main Adapter: LIA 006
Remote Adapter: LIA 006

Test Summary: **PASS**

Wire Map	12345678	12345678
PASS	12345678	12345678

Length (ft)	(Pair 12)	8
Prop. Delay (ns)	(Pair 36)	13
Delay Skew (ns)	(Pair 24)	1
Resistance (ohms)		N/A

	Worst Case Margin	Worst Case Value
PASS	MAIN SR	MAIN SR
Worst Pair	36.7%	36.7%
NEXT (dB)	6.3	7.3
Fines (dB)	4.3	100.0
Limit (dB)	61.7	36.0

	Worst Pair	MAIN SR	MAIN SR
RL (dB)	45	45	
Fines (dB)	6.3	10.0	
Limit (dB)	24.0	18.0	

FLUKE networks

HDMI OVER ONE CAT5e UTP CABLE

HDMI V1.3 EXTENDER OVER ONE CAT5/6 CABLE - ACTIVE

- Extends the transmission distance up to 200ft @1080i or 150ft @1080/60p
- Supports up to 7.1-Channel surround sound audio
- HDMI 1.3 compliant
- HDCP compatible
- Adjustable 8-level EQ control for video quality on receiver & EDID learning ability on transmitter for active application
- Transmitter: 1 x HDMI input / 1 x RJ45 output
- Receiver: 1 x RJ45 input / 1 x HDMI output
- Detachable surface mount bracket included

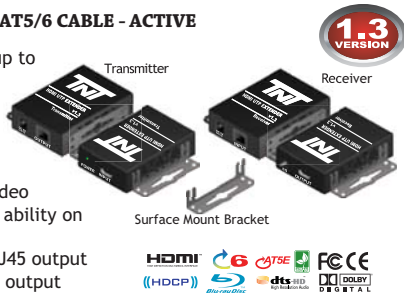

PART NUMBER	DESCRIPTION	1-4	5-9	10+
R01-EXT-HSL	HDMI Extender over 1x Cat5/6 - Active	\$184.00	178.25	172.50

HDMI V1.3 EXTENDER OVER ONE CAT5/6 CABLE - PASSIVE

- Extends the transmission distance up to 100ft @1080i or 50ft @1080/60p
- HDMI 1.3 compliant
- Transmitter: 1 x HDMI male pigtail input / 1 x RJ45 output
- Receiver: 1 x RJ45 input / 1 x HDMI male pigtail output
- No external power required for receiver and transmitter
- Not HDCP Compliant. Not working with any HDCP required source.



PART NUMBER	DESCRIPTION	1-4	5-9	10+
R01-EXT-HSS	HDMI Extender over 1x Cat5/6 - Passive	\$31.84	30.85	29.85

HDMI DVD Player/BluRay

R01-EXT-HSL
ACTIVE

1.3 VERSION

UTP Cable CAT5/5e/6 up to 200ft @1080i or 150ft @1080/60p

HDMI Source without HDCP requirement

R01-EXT-HSS
PASSIVE

1.3 VERSION

UTP Cable CAT5/5e/6 up to 50ft @1080/60p

HDMI OVER TWO CAT5e UTP CABLE

HDMI UTP EXTENDER

- Fully automatic equalization up to 40dB, no system control required
- Extend high definition displays up to 150 feet by UTP Cable from the source
- Eliminate equipment noise in the viewing environment
- Support 480P, 720P, 1080i, 1080/24p resolutions
- HDMI and HDCP compliant
- Cable skew compensation improvement
- Cost saving for plenum cable request application

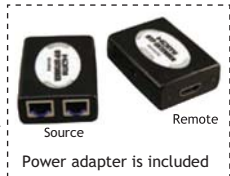

PART NUMBER	DESCRIPTION	1-4	5-9	10+
R01-EXT-C5E-P	HDMI UTP Extender, Plastic enclosure	\$48.80	47.28	45.75

ADDITIONAL FEATURES FOR HDMI UTP EXTENDER

- 110 TYPE FACEPLATE**
- Decora Type Wall Plate with 110 Punch down IDC Terminal



PART NUMBER	DESCRIPTION	1-4	5-9	10+
R01-EXT-C5E-FP	HDMI UTP Extender 110 Type Face Plate	\$43.20	41.85	40.50

ADDITIONAL FEATURES FOR HDMI UTP EXTENDED 1x4 SPLITTER

- Allow to use HDMI cable to directly cascade to next splitter without losing HDMI signal strength

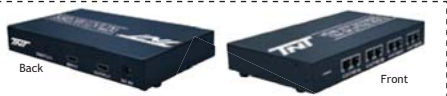

ADDITIONAL FEATURES FOR 19" RACK MOUNT PANEL:

- 19 inch 1U panel mountable designed enclosure - easy to manage signal distribution through UTP structure cabling system

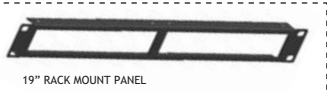

PART NUMBER	DESCRIPTION	1-4	5-9	10+
R01-SPL-C5E-104B	HDMI UTP Extended 1x4 Splitter	\$136.00	131.75	127.50
R01-SPL-PANEL	19" 1U Blank Rack Mount Panel	30.40	29.45	28.50
R01-EXT-C5E-RX-FP	HDMI UTP 110 Faceplate Remote	28.80	27.90	27.00
R01-EXT-C5E-RX	HDMI UTP Extender Remote	29.60	28.68	27.75

HDMI DVD Player

UP TO 150FT

UTP Cable CAT5/5e/6

HDMI DVD Player

UP TO 150FT

UTP Cable CAT5/5e/6

HDTV 01, HDTV 02, DVD, LOCAL HDTV, HDTV 03, HDTV 04, HDTV 05

UP TO 150FT

CAT5/5e/6 Cable

HDMI SWITCH

- Switch easily between any 2 to 5 HDMI V1.3 sources
- Maintain 480p, 720p, 1080i, 1080/24p and 1080/60p resolutions
- Maintain highest HDMI single link video resolutions
- Maintain highest HDMI digital audio signal
- Connect to HDMI cable to input or output
- Switch inputs with the IR remote control or MANUAL push button
- Automatism search current signal input when turn on product or by controller
- HDCP and HDMI 1.3 version Compliant
- Install within seconds
- Auto power and switching
- Compact enclosure, AC/DC Power Adapter included

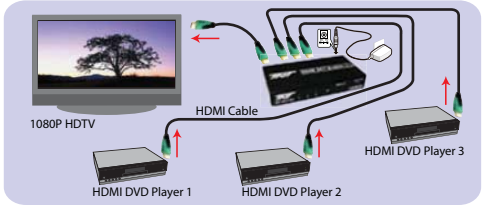

PART NUMBER	DESCRIPTION	1-4	5-9	10+
R01-SWT-201	HDMI 2 to 1 Switch, Plastic	\$35.20	34.10	33.00
R01-SWT-301	HDMI 3 to 1 Switch, Metal	60.80	58.90	57.00
R01-SWT-501	HDMI 5 to 1 Switch, Metal	83.20	80.60	78.00

HDMI SPLITTER

- Distribute HD signals with zero loss to four HDMI Displays
- Maintain 720i, 720p, 1080i, and 1080p resolutions
- Maintain highest HDMI digital audio signal
- Display multiple devices simultaneously
- HDCP and HDMI V1.3 Compliant
- Install within seconds



PART NUMBER	DESCRIPTION	1-4	5-9	10+
R01-SPL-102	HDMI 1 to 2 Splitter	\$59.20	57.35	55.50
R01-SPL-104	HDMI 1 to 4 Splitter	113.60	110.05	106.50

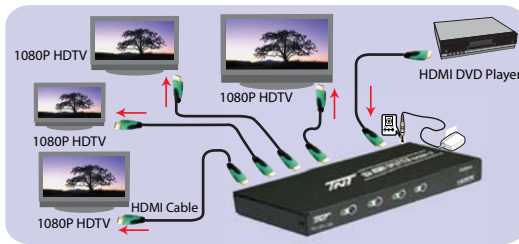

HDMI EQUALIZER/EXTENDER

The HDMI Extender automatically adjusts and compensates for cable attenuation up to 40dB. In addition, it can be powered directly from the cable without an external power supply up to 150 feet which is ideal for long distance application.

* It is recommended to use equalizer for distance over 25 feet.



HDMI Extender/Equalizer HDMI Extender Pigtail HDMI Faceplate with Extender Built-in



PART NUMBER	DESCRIPTION	1-4	5-9	10+
R01-EQL-FF-B	HDMI Extender	\$25.60	24.80	24.00
R01-EQL-MF-01-B	HDMI Extender Pigtail Adapter Cable	24.00	23.25	22.50
R01-EQL-FF-FA-B	HDMI Wallplate w/ Extender Built-in	25.60	24.80	24.00

R01-EQL-MF-01-B



HDMI CONVERTER

- Easily switch between Y-Pb-Pr + Stereo Audio to HDTV
- Support HDTV resolution up to 1080i
- HDCP Compliant
- Install in seconds
- Allow to connect DVD etc. with component output to a HDMI display



PART NUMBER	DESCRIPTION	1-4	5-9	10+
R01-CVT-01	Component to HDMI Converter	\$52.80	51.15	49.50

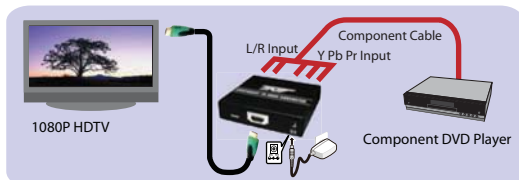

HDMI CABLES

HDMI TO HDMI CABLE 1.4 VERSION

PART NUMBER	LENGTH	1-24	25-49	50+
E104-HDMI-HDMI-03	3 ft	\$8.54	8.15	7.57
E104-HDMI-HDMI-06	6 ft	12.32	11.76	10.92
E104-HDMI-HDMI-10	10 ft	16.19	15.46	14.35
E104-HDMI-HDMI-15	15 ft	23.67	22.60	20.98

HDMI TO HDMI CABLE 1.4 VERSION, RIGHT ANGLE

PART NUMBER	LENGTH	1-24	25-49	50+
E104-HDMI-LL-03	3 ft	\$9.42	9.00	8.35
E104-HDMI-LL-06	6 ft	13.20	12.62	11.70
E104-HDMI-LL-10	10 ft	17.07	16.33	15.13
E104-HDMI-LL-15	15 ft	24.55	23.48	21.76

HDMI TO HDMI CABLE 1.3 VERSION

PART NUMBER	LENGTH	1-24	25-49	50+
E103-HDMI-HDMI-03	3 ft	\$7.13	6.82	6.32
E103-HDMI-HDMI-06	6 ft	9.59	9.17	8.50
E103-HDMI-HDMI-10	10 ft	12.67	12.12	11.23
E103-HDMI-HDMI-15	15 ft	16.54	15.82	14.66
E103-HDMI-HDMI-25	25 ft	24.20	23.14	21.45

HDMI TO HDMI CABLE 1.3 VERSION (24 AWG)

PART NUMBER	LENGTH	1-24	25-49	50+
E103-HDMI-100-24	100 ft	\$125.14	119.66	110.92
E103-HDMI-125-24	125 ft	154.70	147.94	137.12
E103-HDMI-150-24	150 ft	184.54	176.46	163.57

HDMI TO HDMI CABLE 1.3 VERSION, RIGHT ANGLE

PART NUMBER	LENGTH	1-24	25-49	50+
E103-HDMI-LL-03	3 ft	\$8.01	7.66	7.10
E103-HDMI-LL-06	6 ft	10.47	10.01	9.28
E103-HDMI-LL-10	10 ft	13.55	12.96	12.01
E103-HDMI-LL-15	15 ft	25.08	23.98	22.23

HDMI TO HDMI CABLE 1.3 VERSION, FLAT

PART NUMBER	LENGTH	1-24	25-49	50+
E103-HDMI-03-FL	3 ft	\$7.13	6.82	6.32
E103-HDMI-06-FL	6 ft	9.59	9.17	8.50
E103-HDMI-10-FL	10 ft	12.67	12.12	11.23
E103-HDMI-15-FL	15 ft	16.54	15.82	14.66

MINI HDMI TO MINI HDMI CABLE 1.3 VERSION

PART NUMBER	LENGTH	1-24	25-49	50+
E103-MHDMI-MHDMI-03	3 ft	\$10.74	10.27	9.52
E103-MHDMI-MHDMI-06	6 ft	13.20	12.62	11.70
E103-MHDMI-MHDMI-10	10 ft	17.51	16.75	15.52
E103-MHDMI-MHDMI-15	15 ft	20.68	19.78	18.33

MINI HDMI TO HDMI CABLE 1.3 VERSION

PART NUMBER	LENGTH	1-24	25-49	50+
E103-MHDMI-HDMI-03	3 ft	\$9.33	8.92	8.27
E103-MHDMI-HDMI-06	6 ft	11.79	11.28	10.45
E103-MHDMI-HDMI-10	10 ft	16.02	15.32	14.20
E103-MHDMI-HDMI-15	15 ft	19.36	18.51	17.16

HDMI TO HDMI CABLE 1.3 VERSION, SWIVEL

PART NUMBER	LENGTH	1-24	25-49	50+
E103-HDMI-03-SW	3 ft	\$7.48	7.15	6.63
E103-HDMI-06-SW	6 ft	10.12	9.68	8.97
E103-HDMI-10-SW	10 ft	13.38	12.79	11.86
E103-HDMI-15-SW	15 ft	17.42	16.66	15.44

HDMI TO DVI CABLE 1.3 VERSION

PART NUMBER	LENGTH	1-24	25-49	50+
E103-HDMI-DVI-03	3 ft	\$16.02	15.32	14.20
E103-HDMI-DVI-06	6 ft	18.48	17.67	16.38
E103-HDMI-DVI-10	10 ft	21.12	20.20	18.72
E103-HDMI-DVI-15	15 ft	25.52	24.40	22.62

HDMI ADAPTERS



PART NUMBER	DESCRIPTION	1-24	25-49	50+
E11-HDMI-FF-01	HDMI Female to Female Adapter	\$6.16	5.88	5.46
E11-HDMI-FF-02	HDMI Female to Female, Panel Mountable Adapter	5.63	5.38	4.99

HDMI ADAPTERS

- For use with computers, digital displays, projectors, LCD screens and plasma TVs.
- Supports high-bandwidth, uncompressed digital video, multi-channel digital and control functions.
- Compatible with HDTV and HDCP (High-Bandwidth Digital Content Protection).



PART NUMBER	DESCRIPTION	1-24	25-49	50+
E11-HM-DF	HDMI Male to DVI Female Adapter	\$6.16	5.88	5.46
E11-HF-DM	HDMI Female to DVI Male Adapter	6.16	5.88	5.46
E11-HDMI-MF-SW	HDMI Male to HDMI Female, Swivel Adapter	4.14	3.95	3.67
E11-HDMI-FF-SW	HDMI Female to HDMI Female, Swivel Adapter	4.31	4.12	3.82

DVI EXTENDER OVER ONE CAT5/6 CABLE - ACTIVE

- Extends the transmission distance up to: 200ft @1024x768, XGA or 100ft @1600x1200, UXGA
- DVI 1.1 compliant (Bandwidth = 4.95 Gbps)
- Adjustable 8-level EQ control for video quality on receiver
- Transmitter: Pigtail Style: 1xDVI male 6" pigtail input/1xRJ45 jack output; Wall Plate Style: 1xDVI female input/1x4-pair 110 Terminal output
- Receiver: Box Style: 1xRJ45 jack input/1xDVI female output; Wall Plate Style: 1x4-pair 110 Terminal input/1xDVI female output
- Detachable surface mount bracket included for box style
- One AC/DC 5V 2A adapter included for active box and wall plate style

Wall Plate Style Set (R05-EXT-DSL-FP)



110 Type Punch Down Terminal and screwdriver are included

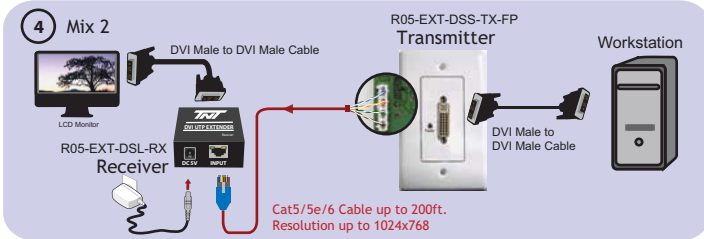
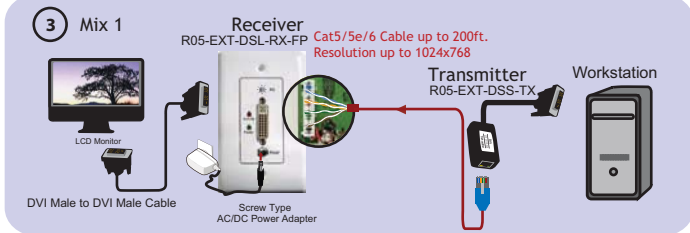
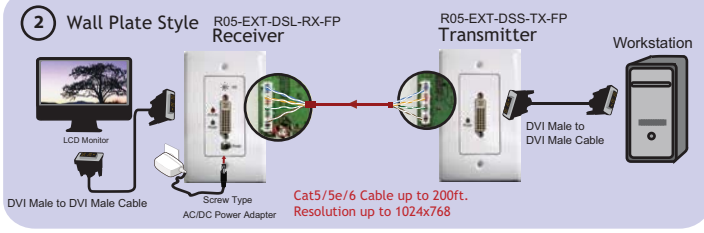
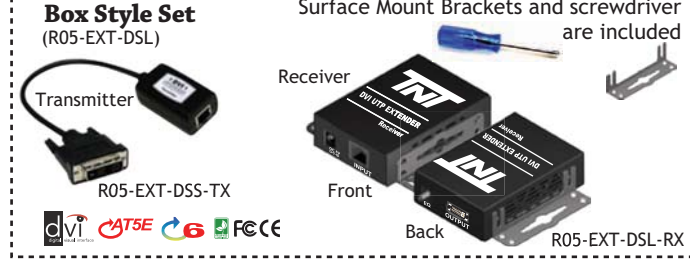
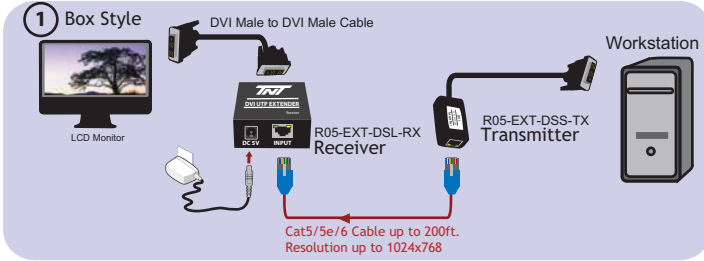
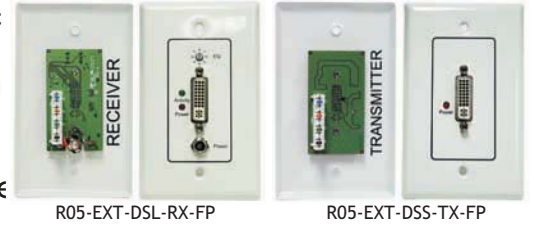

SOLD AS SET (TRANSMITTER AND RECEIVER)

PART NUMBER	DESCRIPTION	1-4	5-9	10+
R05-EXT-DSL	DVI Extender UTP - Active Box Style	\$120.00	116.25	112.50
R05-EXT-DSL-FP	DVI Extender UTP - Active Wall Plate Style	108.80	105.40	102.00

SOLD AS INDIVIDUAL UNIT

PART NUMBER	DESCRIPTION	1-4	5-9	10+
R05-EXT-DSL-RX	Active Box Style, Receiver	\$105.60	102.30	99.00
R05-EXT-DSS-TX	Passive Box Style, Transmitter	16.80	16.28	15.75
R05-EXT-DSL-RX-FP	Active Wall Plate Style, Receiver	96.80	93.78	90.75
R05-EXT-DSS-TX-FP	Passive Wall Plate Style, Transmitter	15.84	15.35	14.85

DVI OVER ONE CAT5e UTP CABLE - PASSIVE / SHORT DISTANCE

DVI EXTENDER OVER ONE CAT5/6 CABLE - PASSIVE

- Extends the transmission distance up to: 100ft @1024x768, XGA or 50ft @1600x1200, UXGA
- DVI 1.1 compliant (Bandwidth = 4.95 Gbps)
- Transmitter: Pigtail Style: 1xDVI male pigtail input/1xRJ45 jack output; Wall Plate Style: 1xDVI female input/1x4-pair 110 Terminal output
- Receiver: Pigtail Style: 1xRJ45 jack input/1xDVI male 6" pigtail output; Wall Plate Style: 1x4-pair 110 Terminal input/1xDVI female output
- **No external power required**

Wall Plate Style Set (R05-EXT-DSS-FP)



110 Type Punch Down Terminal and screwdriver are included

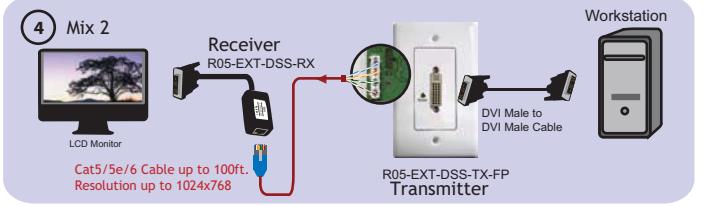
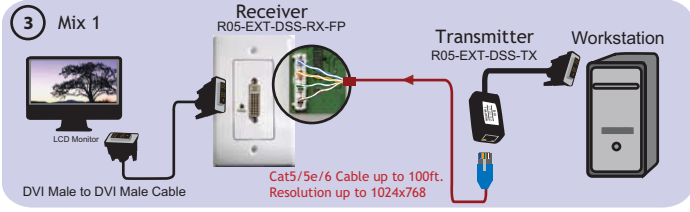
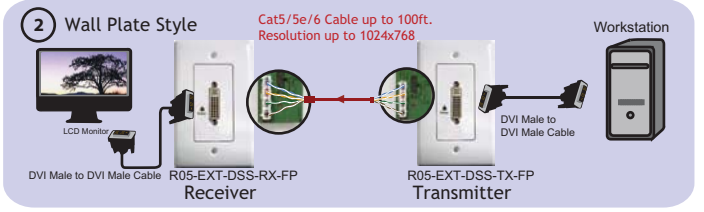
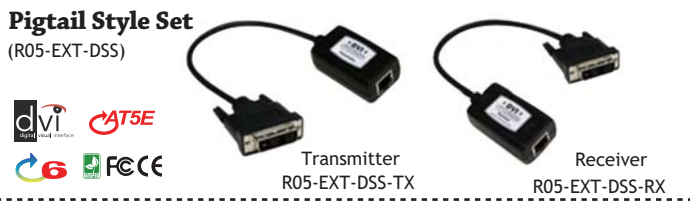
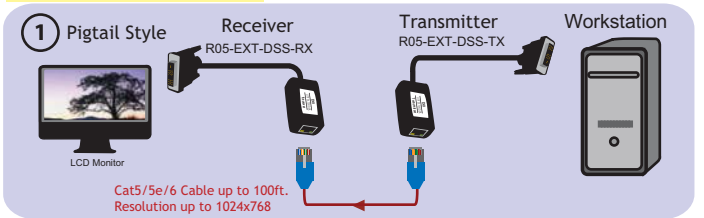

SOLD AS SET (TRANSMITTER AND RECEIVER)

PART NUMBER	DESCRIPTION	1-4	5-9	10+
R05-EXT-DSS	DVI Extender UTP - Passive Pigtail Style	\$31.84	30.85	29.85
R05-EXT-DSS-FP	DVI Extender UTP - Passive Wall Plate Style	30.40	29.45	28.50

SOLD AS INDIVIDUAL UNIT

PART NUMBER	DESCRIPTION	1-4	5-9	10+
R05-EXT-DSS-RX	Passive Pigtail Style, Receiver	\$17.60	17.05	16.50
R05-EXT-DSS-TX	Passive Pigtail Style, Transmitter	16.80	16.28	15.75
R05-EXT-DSS-RX-FP	Passive Wall Plate Style, Receiver	16.00	15.50	15.00
R05-EXT-DSS-TX-FP	Passive Wall Plate Style, Transmitter	15.84	15.35	14.85

SURFACE / RACK MOUNTABLE, CASCADABLE DVI UTP EXTENDED SPLITTERS

- For Active: extends the transmission distance up to: 200ft @1024x768, XGA or 100ft @1600x1200, UXGA
- For Passive: extends the transmission distance up to: 100ft @1024x768, XGA or 50ft @1600x1200, UXGA
- DVI 1.1 compliant (Bandwidth = 4.95 Gbps)
- Connect computer with DVI up to 12 remote DVI monitors and 1 local monitor in 1U 19" panel
- Connect splitter and monitor by using regular Cat5/5e/6 cable
- 19" 1U panel mountable designed enclosure - easy to manage signal distribution thru UTP structure cabling system.
- Allow to use DVI cable directly cascade to next splitter without lost DVI signal.

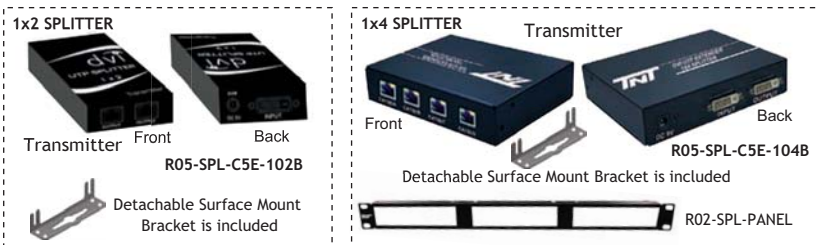

ACTIVE / LONG DISTANCE

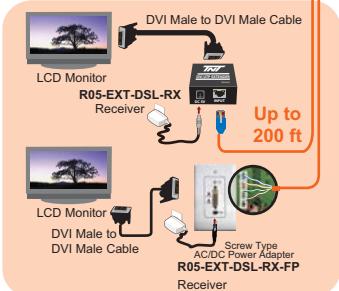

PASSIVE / SHORT DISTANCE

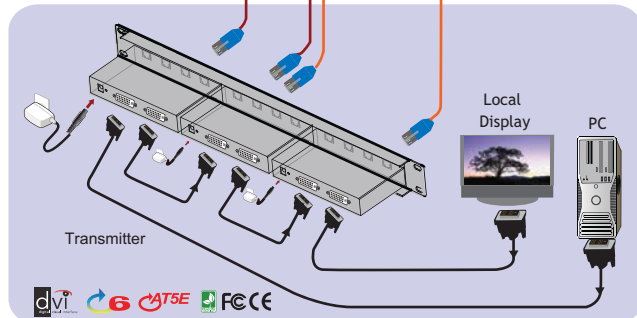
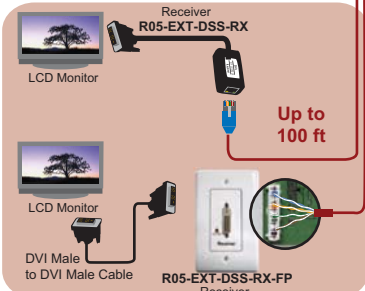

PART NUMBER	1-4	5-9	10+
R05-EXT-DSL-RX	\$105.60	102.30	99.00
R05-EXT-DSS-TX	16.80	16.28	15.75
R05-EXT-DSL-RX-FP	96.80	93.78	90.75
R05-EXT-DSS-TX-FP	15.84	15.35	14.85

PART NUMBER	1-4	5-9	10+
R05-EXT-DSS-RX	\$17.60	17.05	16.50
R05-EXT-DSS-TX	16.80	16.28	15.75
R05-EXT-DSS-RX-FP	16.00	15.50	15.00
R05-EXT-DSS-TX-FP	15.84	15.35	14.85

PART NUMBER	DESCRIPTION	1-4	5-9	10+
R05-SPL-C5E-102B	DVI UTP Extended 1x2 Splitter	\$82.40	79.83	77.25
R05-SPL-C5E-104B	DVI UTP Extended 1x4 Splitter	159.60	154.61	149.63
R02-SPL-PANEL	19" 1U Panel Mountable	30.40	29.45	28.50

DVI FIBER EXTENDER

- Extend all VESA resolution up to WUXGA (1920x1200 @60Hz) DVI data up to 500 meters (1,640 ft).
- Detachable features with 2 pairs of duplex LC or 4LC 50/125 multi-mode fiber patch cords.
- Includes 2 +5VDC power adapters for the transmitter and receiver.

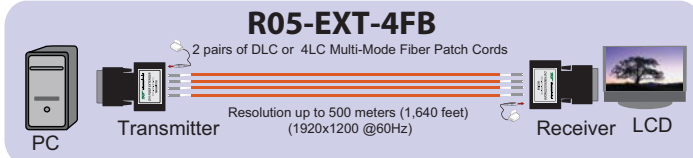

PART NUMBER	DESCRIPTION	1-4	5-9	10+
R05-EXT-4FB	DVI Fiber Extender (Transmitter & Receiver)	\$350.40	339.45	328.50

DVI SPLITTERS WITH AUDIO & EQUALIZER

DVI + AUDIO SPLITTER

- DVI 1 in, 2 or 4 DVI out Splitter + Audio
- DVI 1.1 compliant (Bandwidth = 4.95 Gbps)
- Connect splitter and monitor by using DVI cable

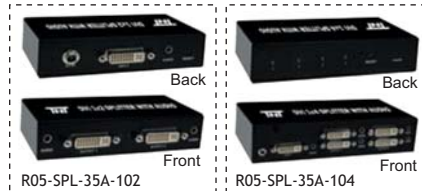

PART NUMBER	DESCRIPTION	1-4	5-9	10+
R05-SPL-35A-102	DVI 1 in, 2 out Splitter with Audio	\$57.60	55.80	54.00
R05-SPL-35A-104	DVI 1 in, 4 out Splitter with Audio	126.40	122.45	118.50

DVI EQUALIZER/EXTENDER

- DVI 1 in, 1 DVI out
- Compatible for DTV resolution up to 1080p or Computer resolution up to UXGA 1920x1200
- Power adapter is included



PART NUMBER	DESCRIPTION	1-4	5-9	10+
R05-EQL-FF	DVI Equalizer/Extender up to 150 ft.	43.20	41.85	40.50

DVI CABLES

A. DVI-D DL (Male)	DVI-D DL (Male)			
PART NUMBER	DESCRIPTION	1-24	25-49	50+
E08-DM-DM-D-06	DVI-D Digital Dual Link, Male to Male, 6 feet	\$14.08	13.44	12.48
E08-DM-DM-D-10	DVI-D Digital Dual Link, Male to Male, 10 feet	16.28	15.54	14.43
E08-DM-DM-D-15	DVI-D Digital Dual Link, Male to Male, 15 feet	20.77	19.82	18.41
B. DVI-D DL (Male)	DVI-D DL (Female)			
PART NUMBER	DESCRIPTION	1-24	25-49	50+
E08-DM-DF-D-06	DVI-D Digital Dual Link, Male to Female, 6 feet	\$16.72	15.96	4.82
E08-DM-DF-D-10	DVI-D Digital Dual Link, Male to Female, 10 feet	18.48	17.64	16.38
E08-DM-DF-D-15	DVI-D Digital Dual Link, Male to Female, 15 feet	22.00	21.00	19.50
C. DVI-I (Male)	DVI-I (Male)			
PART NUMBER	DESCRIPTION	1-24	25-49	50+
E08-ADM-ADM-D-06	DVI-I Analog + Digital Dual Link, Male to Male, 6 feet	\$16.72	15.54	14.43
E08-ADM-ADM-D-10	DVI-I Analog + Digital Dual Link, Male to Male, 10 feet	18.48	17.64	16.38
D. DVI-I (Male)	DVI-I (Female)			
PART NUMBER	DESCRIPTION	1-24	25-49	50+
E08-ADM-ADF-D-06	DVI-I Analog + Digital Dual Link, Male to Female, 6 feet	\$17.25	16.46	15.29
E08-ADM-ADF-D-10	DVI-I Analog + Digital Dual Link, Male to Female, 10 feet	21.12	20.16	18.72
E. DVI-Analog (Male)	VGA HD-DB15 (Male)			
PART NUMBER	DESCRIPTION	1-24	25-49	50+
E08-AM-HD15M-06	DVI Analog Male to HD15 Male, 6 feet	\$10.21	9.74	9.05
E08-AM-HD15M-10	DVI Analog Male to HD15 Male, 10 feet	11.97	11.42	0.61
E08-AM-HD15M-15	DVI Analog Male to HD15 Male, 15 feet	15.49	14.78	13.73

DVI SPLITTER CABLES

PART NUMBER	DESCRIPTION	1-24	25-49	50+
E08-DM-2DF-01	DVI Male to 2 DVI Female Splitter Cable, 1 ft.	\$11.62	11.09	10.30
E08-DM-2HD15F-01	DVI Male to 2 VGA (HD15) Female Splitter Cable, 1 ft.	8.80	8.40	7.80

DVI ADAPTERS

A. DVI-Digital (Female)	DVI-Digital (Male)			
PART NUMBER	DESCRIPTION	1-24	25-49	50+
E09-DF-DM	DVI Digital Female to DVI Digital Male	\$10.56	10.08	9.36
B. DVI-Analog (Male)	VGA HD-DB15 (Female)			
PART NUMBER	DESCRIPTION	1-24	25-49	50+
E09-AM-HD15F	DVI Analog Male to VGA HD-DB15 Female	\$7.92	7.56	7.02
C. DVI-Analog (Female)	VGA HD-DB15 (Male)			
PART NUMBER	DESCRIPTION	1-24	25-49	50+
E09-AF-HD15M	DVI Analog Female to VGA HD-DB15 Male	\$9.68	9.24	8.58
D. DVI-Digital (Male)	DFP Digital (Female)			
PART NUMBER	DESCRIPTION	1-24	25-49	50+
E09-DM-DFPF	DVI Digital Male to DFP Digital Female	\$10.56	10.08	9.36
E. DVI-Digital (Female)	DVI-Digital (Female)			
PART NUMBER	DESCRIPTION	1-24	25-49	50+
E09-DF-DF	Low Profile DVI Female to DVI Female Gender Changer	\$7.92	7.56	7.02

VGA UTP EXTENDER (BOX STYLE AND WALL PLATE STYLE)

- Extend VGA signal up to 500 ft. using only ONE inexpensive Cat5/5e/6 cable or 1000 ft. using Belden Skew-Free Cable.
- Support resolution up to 1920x1440.
- Works with monitors, projectors, HDTV and flat panels.
- Transmitter modules has loop-thru port for local monitor.



Metal Wall Plate Style Set (R02-EXT-FP)



1 Box Style

Receiver
Transmitter

VGA Cable
Local Monitor
Workstation

- Cat5/5e/6 Cable up to 500 ft.
- Belden skew-free cable up to 1000 ft.
- Resolution up to 1920x1440

Box Style Set (R02-EXT-C5E)

Receiver R02-EXT-C5E-RMT
Transmitter R02-EXT-C5E-TX

VGA Cat 5e Cat 6 Cat 5e FC CE

2 Wall Plate Style

Receiver
Transmitter

VGA Cable
Local Monitor
Workstation

- Cat5/5e/6 Cable up to 500 ft.
- Belden skew-free cable up to 1000 ft.
- Resolution up to 1920x1440

3 Mix 1

Receiver
Transmitter

VGA Cable
Local Monitor
Workstation

- Cat5/5e/6 Cable up to 500 ft.
- Belden skew-free cable up to 1000 ft.
- Resolution up to 1920x1440

4 Mix 2

Receiver
Transmitter

VGA Cable
Local Monitor
Workstation

- Cat5/5e/6 Cable up to 500 ft.
- Belden skew-free cable up to 1000 ft.
- Resolution up to 1920x1440

SOLD AS SET (Transmitter & Receiver)

PART NUMBER	DESCRIPTION	1-4	5-9	10+
R02-EXT-C5E	VGA UTP Extender - Box Style	\$104.00	100.75	97.50
R02-EXT-FP	VGA UTP Extender - Wall Plate Style	99.20	96.10	93.00

SOLD AS INDIVIDUAL UNIT

PART NUMBER	DESCRIPTION	1-4	5-9	10+
R02-EXT-C5E-RMT	VGA UTP Extender, Box Style, Receiver	\$60.00	58.13	56.25
R02-EXT-C5E-TX	VGA UTP Extender, Box Style, Transmitter	51.20	49.60	48.00
R02-EXT-TX-FP	VGA UTP Extender, Wallplate, Transmitter	49.60	48.05	46.50
R02-EXT-RX-FP	VGA UTP Extender, Wallplate, Receiver	55.20	53.48	51.75

RACK MOUNTABLE, CASCADABLE VGA UTP EXTENDED 1X4 SPLITTER

- Connect computers with VGA graphics up to 13 VGA compatible monitors or projectors in 1U 19" panel.
- Connect splitter and monitor by using regular Cat5/5e/6 cable.
- Maintain highest video resolution up to 1920x1440.
- 19" 1U panel mountable designed enclosure - easy to manage signal distribution thru UTP structure cabling system.
- Allow to use VGA cable directly cascade to next splitter without lost VGA signal.



PART NUMBER	DESCRIPTION	1-4	5-9	10+
R02-SPL-C5E-102B	VGA UTP Extended 1x2 Splitter	\$65.60	63.55	61.50
R02-SPL-C5E-104B	VGA UTP Extended 1x4 Splitter	104.00	100.75	97.50
R02-EXT-C5E-RMT	VGA UTP Extender Box Style Receiver	60.00	58.13	56.25
R02-EXT-RX-FP	VGA UTP Extender Wall Plate Receiver	55.20	53.48	51.75
R02-SPL-PANEL	1U 19" Panel	30.40	29.45	28.50

RECEIVER
RECEIVER
RECEIVER
RECEIVER

TRANSMITTER

Local Display
PC

- Cat5/5e/6 Cable up to 500 ft.
- Belden skew-free cable up to 1000 ft.
- Resolution up to 1920x1440

VGA Cat 5e Cat 6 Cat 5e FC CE

VGA UTP EXTENDER DAISY CHAINABLE WITH TRANSCEIVER

- Extend VGA signal using ONE UTP Cable.
- High resolution up to 1920 x 1440 @60 Hz.
- Distance up to 500 ft. apart each chain.
- Work with monitors, projectors, HDTV, and flat panels.
- Transceiver built-in daisy chain function.

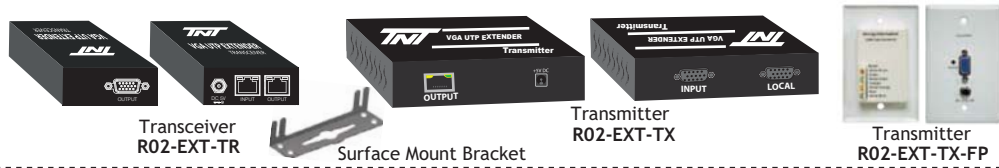

PART NUMBER	DESCRIPTION	1-4	5-9	10+
R02-EXT-TR	VGA UTP Extender Transceiver			CALL FOR PRICE
R02-EXT-TX	VGA UTP Extender Transmitter Box Style			CALL FOR PRICE
R02-EXT-TX-FP	VGA UTP Extender Transmitter Wall Plate	\$49.60	48.05	46.50



VGA UTP EXTENDER DAISY CHAINABLE TRANSCIVER

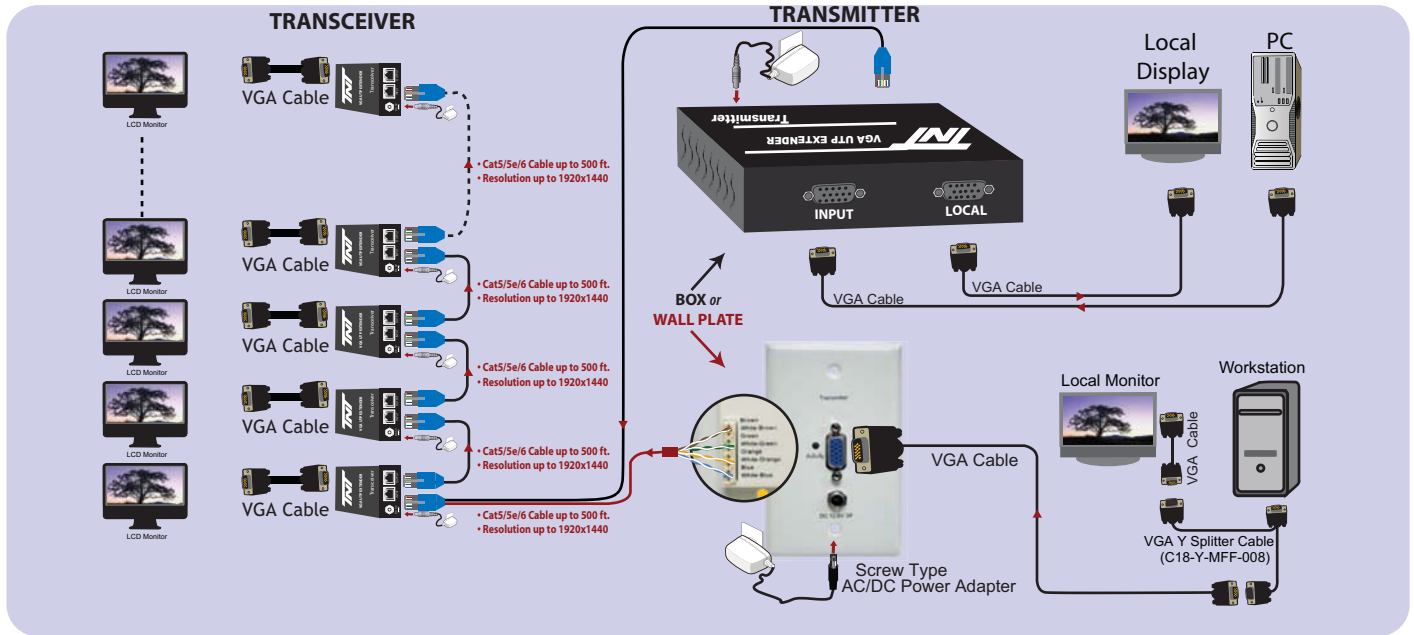

PART NUMBER	DESCRIPTION	1-4	5-9	10+
R02-EXT-TR	VGA UTP Extender Transceiver			CALL FOR PRICE
R02-EXT-TX	VGA UTP Extender Box Style Transmitter			CALL FOR PRICE
R02-EXT-TX-FP	VGA UTP Extender Wall Plate Transmitter	\$49.60	48.05	46.50



VGA + AUDIO UTP EXTENDER

VGA + AUDIO UTP EXTENDER (BOX STYLE AND WALL PLATE STYLE)

- Extend VGA and stereo signal up to 500 ft. using only ONE inexpensive Cat5/5e/6 cable or 1000 ft. using Belden Skew-Free Cable.
- Support resolution up to 1920x1440.
- Works with monitors, projectors, HDTV and flat panels.
- Transmitter modules has loop-thru port for local monitor.

Metal Wall Plate Style Set (R02-EXT-35A-FP)

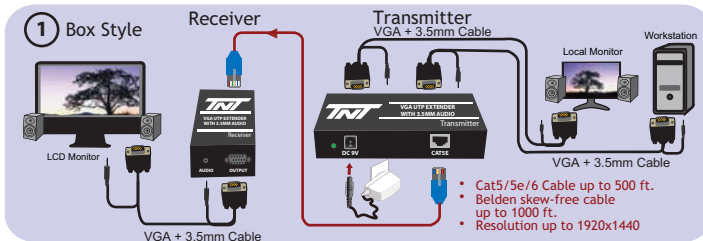

Box Style Set (R02-EXT-C5E-35A)

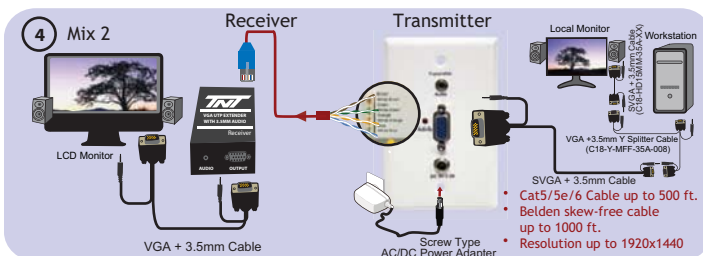
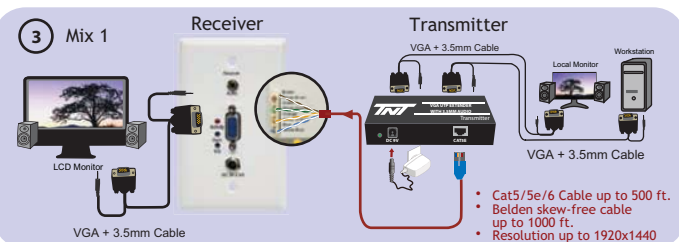
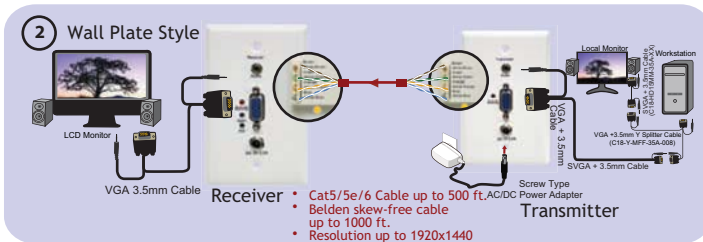

SOLD AS SET (Transmitter & Receiver)

PART NUMBER	DESCRIPTION	1-4	5-9	10+
R02-EXT-C5E-35A	VGA + Audio UTP Extender - Box Style	\$112.00	108.50	105.00
R02-EXT-35A-FP	VGA + Audio UTP Extender - Wall Plate Style	107.20	103.85	100.50

SOLD AS INDIVIDUAL UNIT

PART NUMBER	DESCRIPTION	1-4	5-9	10+
R02-EXT-C5E-35A-RMT	VGA+Audio Extender, Box, Receiver	\$68.80	66.65	64.50
R02-EXT-C5E-35A-TX	VGA+Audio Extender, Box, Transmitter	60.00	58.13	56.25
R02-EXT-35A-TX-FP	VGA+Audio Extender, Wallplate, Transmitter	54.40	52.70	51.00
R02-EXT-35A-RX-FP	VGA+Audio Extender, Wallplate, Receiver	63.20	61.23	59.25

RACK MOUNTABLE, CASCADABLE VGA + AUDIO UTP EXTENDED 1X4 SPLITTER

- Connect computers with VGA graphics up to 13 VGA. compatible monitors or projectors in 1U 19" panel.
- Connect splitter and monitor by using regular ONE Cat5/5e/6 cable.
- Maintain highest video resolution up to 1920x1440.
- 19" 1U panel mountable designed enclosure - easy to manage signal distribution thru UTP structure cabling system.
- Allow to use VGA cable directly cascade to next splitter without lost VGA signal.

PART NUMBER	DESCRIPTION	1-4	5-9	10+
R02-EXT-C5E-35A-102B	VGA+Audio UTP Extended 1x2 Splitter	\$76.00	73.63	71.25
R02-EXT-C5E-35A-104B	VGA+Audio UTP Extended 1x4 Splitter	112.00	108.50	105.00
R02-EXT-35A-RX-FP	VGA+Audio UTP Extender Receiver Wallplate	63.20	61.23	59.25
R02-EXT-C5E-35A-RMT	VGA+Audio UTP Extender Receiver Box Style	68.80	66.65	64.50
R02-SPL-PANEL	19" 1U Panel, fit for 3 transmitters	30.40	29.45	28.50

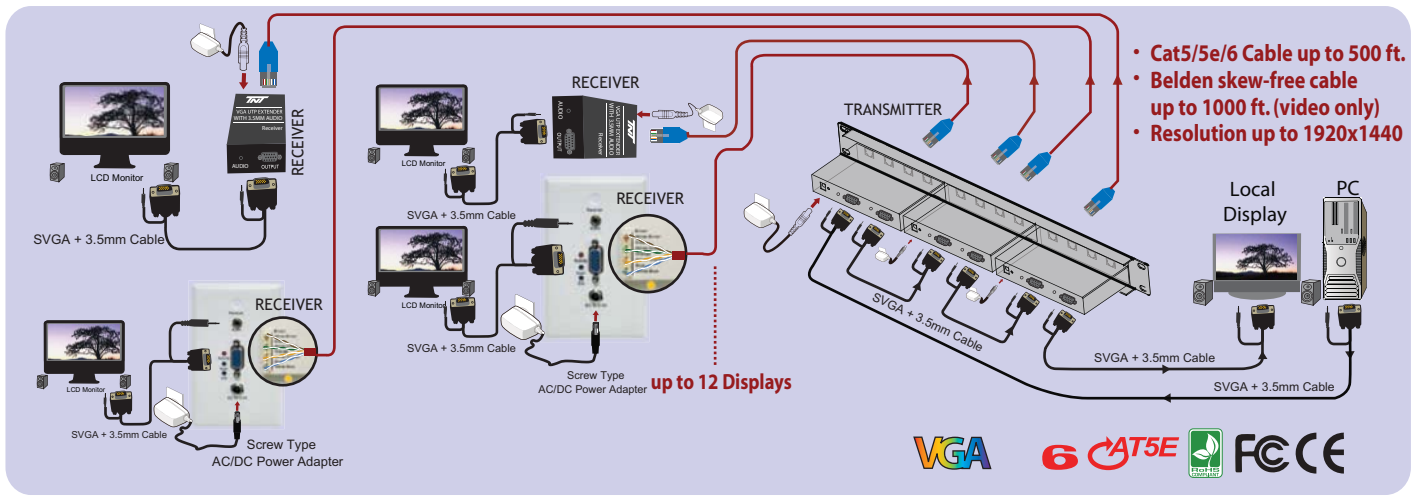
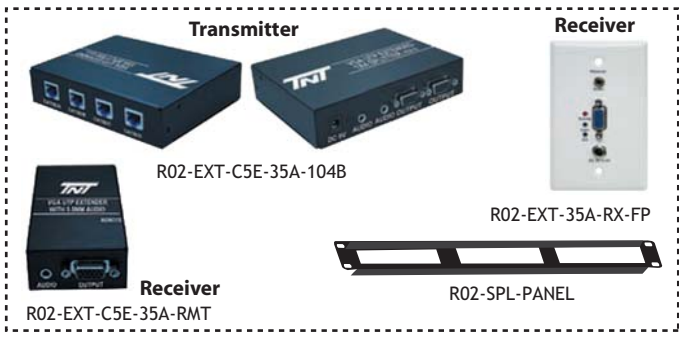

VGA + AUDIO UTP EXTENDER DAISY CHAINABLE WITH TRANSCIEVER

- Extend VGA and stereo signal using ONE UTP Cable.
- High resolution up to 1920x1440 @60 Hz.
- Distance up to 500 ft. apart each chain.
- Work with monitors, projectors, HDTV, and flat panels.
- Transceiver built-in daisy chain function.

PART NUMBER	DESCRIPTION	1-4	5-9	10+
R02-EXT-35A-TR	VGA+Audio UTP Extender Transceiver	CALL FOR PRICE		
R02-EXT-35A-TX	VGA+Audio UTP Extender Transmitter Box Style	CALL FOR PRICE		
R02-EXT-35A-TX-FP	VGA+Audio UTP Extender Transmitter Wall Plate	\$49.60	48.05	46.50

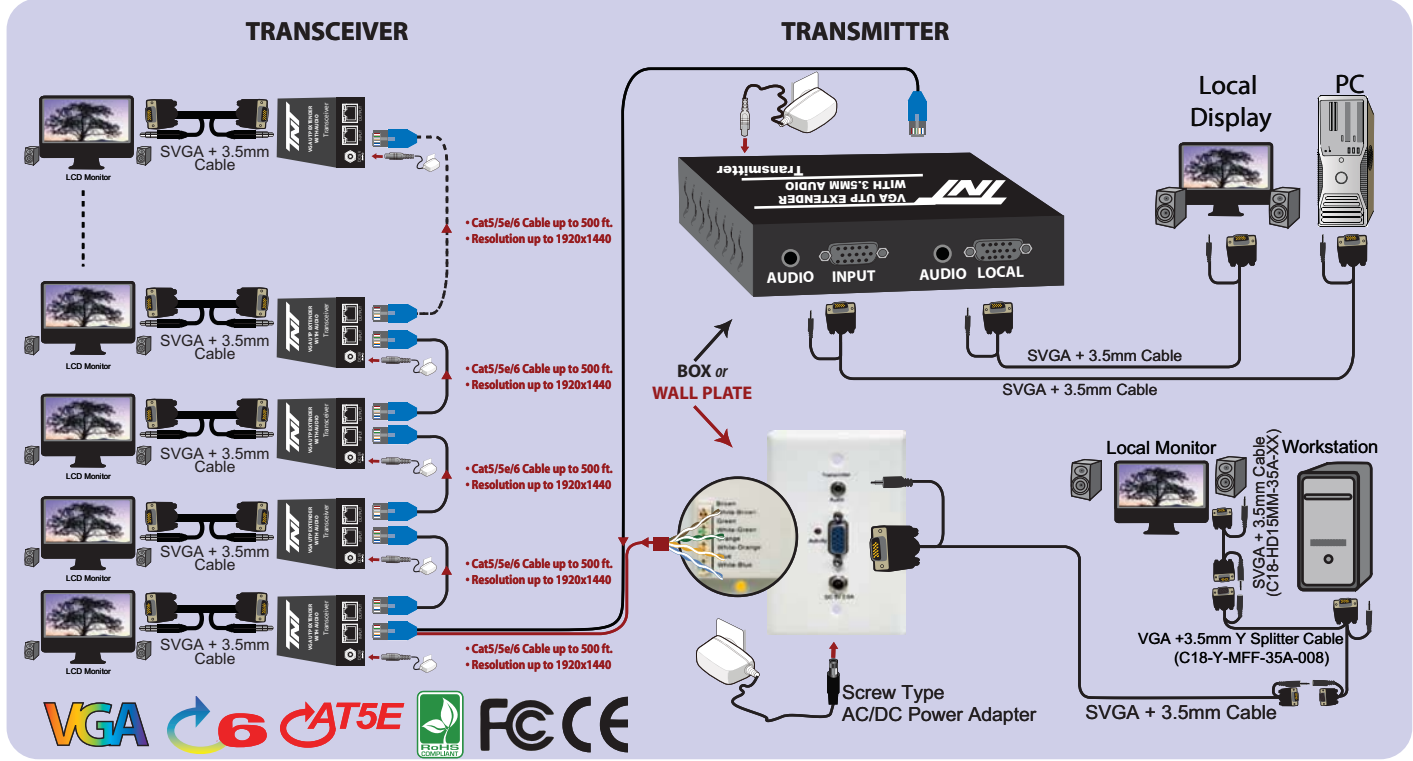
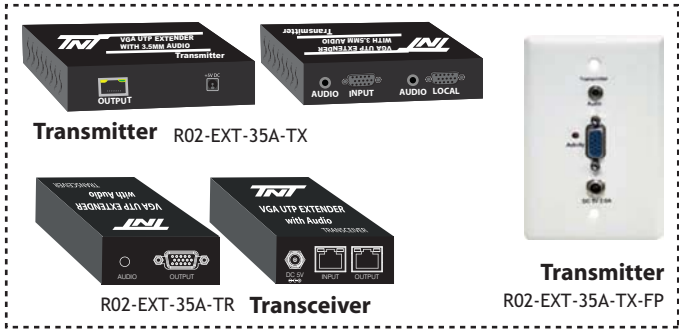

VGA + RS-232 UTP EXTENDER

VGA + RS-232 UTP EXTENDER (BOX STYLE AND WALL PLATE STYLE)

- Extend VGA + RS232 signal using ONE UTP Cable.
- High resolution up to 1920x1440 @60 Hz.
- Distance up to 500 ft. apart or 1000 ft. using Belden Skew-Free cable.
- Work with monitors, projectors, HDTV, and flat panels.
- RS232 works with scanner and touch screen control.



Metal Wall Plate Style Set (R02-EXT-RS-FP)

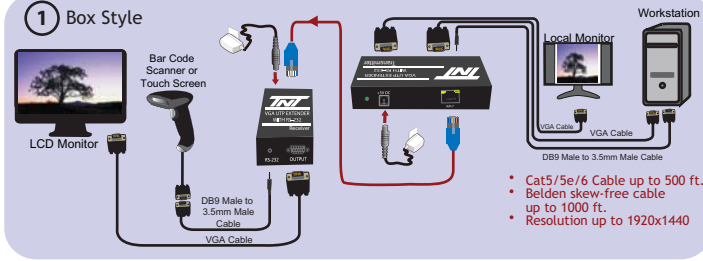
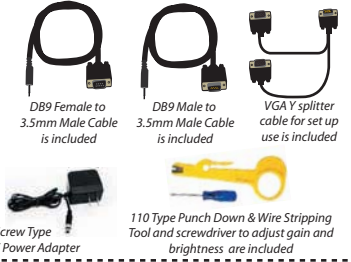

Box Style Set (R02-EXT-C5E-RS)

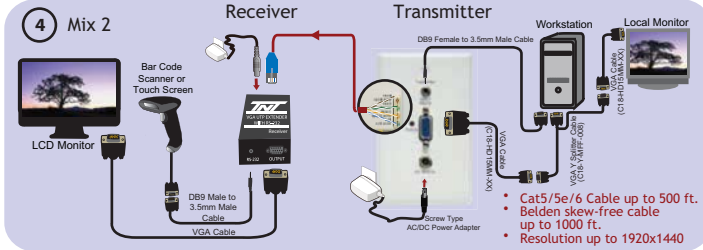
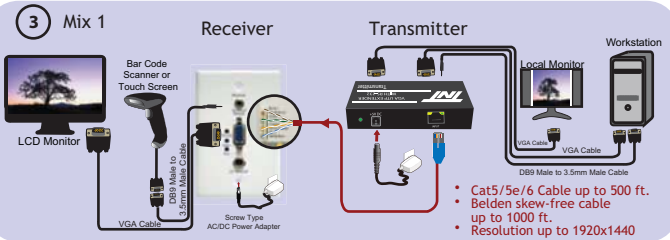
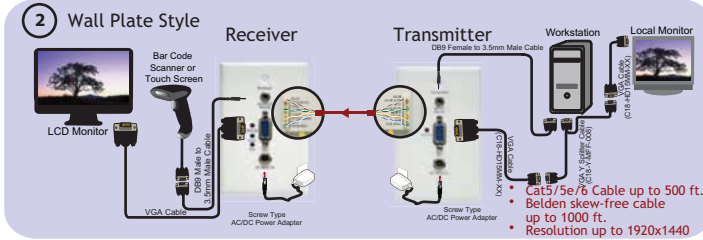
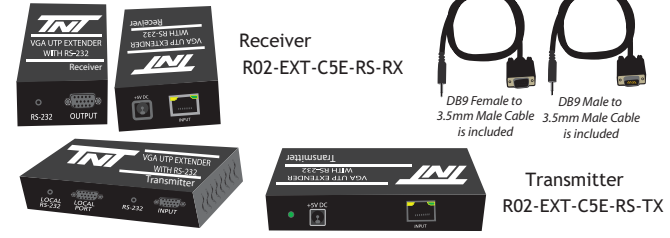

SOLD AS SET (Transmitter & Receiver)

PART NUMBER	DESCRIPTION	1-4	5-9	10+
R02-EXT-C5E-RS	VGA+RS-232 UTP Extender - Box Style	\$126.40	122.45	118.50
R02-EXT-RS-FP	VGA+RS-232 UTP Extender - Wall Plate Style	121.60	117.80	114.00

SOLD AS INDIVIDUAL UNIT

PART NUMBER	DESCRIPTION	1-4	5-9	10+
R02-EXT-C5E-RS-RX	VGA+RS232 Extender, Box, Receiver	\$73.60	71.30	69.00
R02-EXT-C5E-RS-TX	VGA+RS232 Extender, Box, Transmitter	62.40	60.45	58.50
R02-EXT-RS-TX-FP	VGA+RS232 Extender, Wallplate, Transmitter	62.40	60.45	58.50
R02-EXT-RS-RX-FP	VGA+RS232 Extender, Wallplate, Receiver	68.80	66.65	64.50

VGA OVER 4 FIBER EXTENDER

VGA FIBER EXTENDER

- Support highest resolution of 1600x1200@60Hz up to 500 meters (1,640 feet) using 2 pairs of DLC or 4LC 50/125 Multi-Mode Fiber Patch Cords.
- Transmitter's image adjustment in horizontal and vertical way, adjustment of image's sampling clock phase and frequency, adjustment of image's brightness and contrast, adjustment and preservation of all adjustment parameter in all kinds of resolutions.
- Support EDID read of display device and keeps in the system.
- Support the signal input indicates
- Support the optic output indicates
- The input supports the window, easy to use



SOLD AS SET (Transmitter & Receiver)

PART NUMBER	DESCRIPTION	1-4	5-9	10+
R02-EXT-4FB	VGA Fiber Extender	CALL FOR PRICE		

R02-EXT-4FB

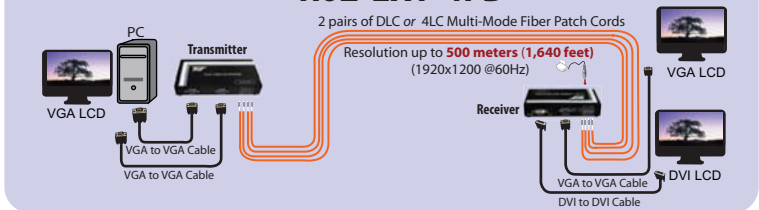

VGA IN, VGA OUT SPLITTER

VGA SPLITTER

- Connect computers with VGA graphics up to 4 VGA (depend on the unit) compatible monitors or projectors.
- Allow up to 4 VGA display monitors to be connected at the same time to the same video source.
- Simultaneously display at local and remote locations.
- Maintain highest video resolution up to 1920x1200
- Install in seconds
- VGA Amplifier Bandwidth: 250 MHz.

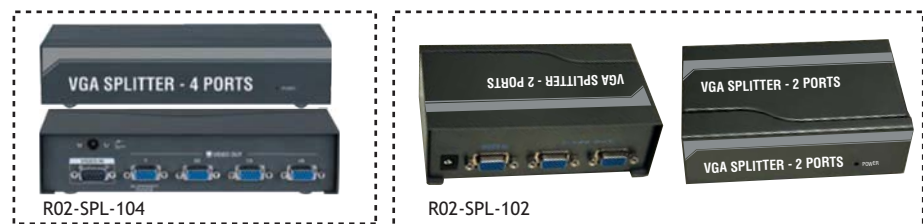

PART NUMBER	DESCRIPTION	1-4	5-9	10+
R02-SPL-102	1 VGA In, 2 VGA Out Splitter	\$41.60	40.30	39.00
R02-SPL-104	1 VGA In, 4 VGA Out Splitter	44.80	43.40	42.00



CMP PLENUM SVGA CABLE

- 28 AWG, spiral shielded coax, 75 Ohm UL1354, aluminum foil and braid shielded with drain wire.
- HD D-sub 15-pin Male, solder type, gold/silver flash contacts and thumb screws molded.
- Hoods molded back, CMP PVC.



C18P-HD15MM-XX

PART NUMBER	DESCRIPTION	PRICE
C18P-HD15MM-50	CMP Plenum HD15 Male to Male, 50 feet	PLEASE CALL FOR PRICE
C18P-HD15MM-75	CMP Plenum HD15 Male to Male, 75 feet	
C18P-HD15MM-100	CMP Plenum HD15 Male to Male, 100 feet	
C18P-HD15MM,MF,FF-XX	CMP Plenum HD15 Male/Female, Custom Length	

ENHANCED VGA MONITOR CABLE

- Extends cable range to up to 100 feet.
- 3 mini coaxial conductors, 2 pairs of individual shielded conductors under one jacket - extends signal integrity.

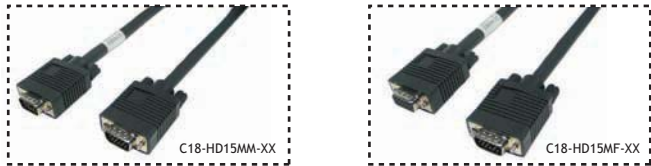

C18-HD15MM-XX

C18-HD15MF-XX

PART NUMBER	DESCRIPTION	1-24	25-49	50+
C18-HD15MM-03	Male to Male, 3 feet	\$4.58	4.37	4.06
C18-HD15MM-06	Male to Male, 6 feet	6.69	6.38	5.93
C18-HD15MM-10	Male to Male, 10 feet	9.68	9.24	8.58
C18-HD15MM-15	Male to Male, 15 feet	13.20	12.60	11.70
C18-HD15MM-25	Male to Male, 25 feet	20.24	19.32	17.94
C18-HD15MM-50	Male to Male, 50 feet	36.96	35.28	32.76
C18-HD15MM-75	Male to Male, 75 feet	54.56	52.08	48.36
C18-HD15MM-100	Male to Male, 100 feet	70.40	67.20	62.40
C18-HD15MF-03	Male to Female, 3 feet	4.58	4.37	4.06
C18-HD15MF-06	Male to Female, 6 feet	6.69	6.38	5.93
C18-HD15MF-10	Male to Female, 10 feet	9.68	9.24	8.58
C18-HD15MF-15	Male to Female, 15 feet	13.20	12.60	11.70
C18-HD15MF-25	Male to Female, 25 feet	20.24	19.32	17.94
C18-HD15MF-50	Male to Female, 50 feet	36.96	35.28	32.76
C18-HD15MF-75	Male to Female, 75 feet	54.56	52.08	48.36
C18-HD15MF-100	Male to Female, 100 feet	70.40	67.20	62.40

VIDEO Y CABLE & ANGLE SVGA CABLE

- SVGA cable: 90° Male, left or right exit, to 180° Male.
- Video Y cable: Splitter cable, HD15 Male to 2x HD15 Female, 8 inches.



PART NUMBER	DESCRIPTION	1-24	25-49	50+
C18-HD15MM-06L	SVGA Cable, Left Exit, 6 feet	\$12.76	12.18	11.31
C18-HD15MM-10L	SVGA Cable, Left Exit, 10 feet	17.60	16.80	15.60
C18-HD15MM-06R	SVGA Cable, Right Exit, 6 feet	12.76	12.18	11.31
C18-HD15MM-10R	SVGA Cable, Right Exit, 10 feet	17.60	16.80	15.60
C18-Y-MFF-008	VGA Y Splitter Cable, 8 inches	4.05	3.86	3.59

SVGA + 3.5mm AUDIO MALE TO MALE CABLE

- VGA Connectors: HD15 Male to HD15 Male.
- Audio Connectors: 3.5mm Male to 3.5mm Male.

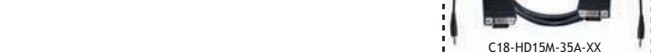

PART NUMBER	DESCRIPTION	1-24	25-49	50+
C18-HD15M-35A-03	SVGA+3.5mm Audio Male to Male, 3 feet	\$5.21	4.67	4.62
C18-HD15M-35A-06	SVGA+3.5mm Audio Male to Male, 6 feet	7.30	6.97	6.47
C18-HD15M-35A-10	SVGA+3.5mm Audio Male to Male, 10 feet	10.12	9.66	8.97
C18-HD15M-35A-15	SVGA+3.5mm Audio Male to Male, 15 feet	13.64	13.02	12.09

HIGH DENSITY DB-15M TO RCA COMPONENT CABLE

- Cable: UL2919, 28AWG to 3 Coax
- Jacket Color: Black Matte PVC and OD = 7.0 ± 0.15mm
- Connector: High Density D-Sub 15-Pin Male to 3RCA Male.
- Gold Plated Pins and Nickel Plated Shell.
- Strain Relief Molding 45P Black PVC.

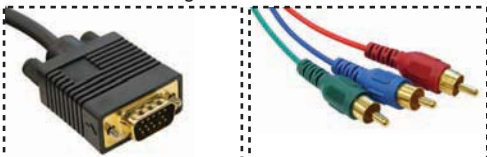

PART NUMBER	DESCRIPTION	1-24	25-49	50+
C32-HD15M-3RM-1M	HD DB-15M to RCA, 1 Meter	\$12.32	11.76	10.92
C32-HD15M-3RM-2M	HD DB-15M to RCA, 2 Meters	14.96	14.28	13.26
C32-HD15M-3RM-3M	HD DB-15M to RCA, 3 Meters	17.60	16.80	15.60

DVI ANALOG MALE TO HD15 MALE CABLE



PART NUMBER	DESCRIPTION	1-24	25-49	50+
E08-AM-HD15M-06	DVI Analog Male to HD15 Male, 6 feet	\$10.21	9.74	9.05
E08-AM-HD15M-10	DVI Analog Male to HD15 Male, 10 feet	11.97	11.42	10.61
E08-AM-HD15M-15	DVI Analog Male to HD15 Male, 15 feet	15.49	14.78	13.73

NANOSKEW PVC PATCH CABLE

Cable: Belden 7987R NanoSkew 24 AWG twisted pairs solid bare copper conductors, non-plenum, polyoefin insulation, skew 2.2ns/100m nominal, rip cord, maroon PVC patch jacket cable.



Connectors: RJ45 with red color boot.

Suitable Applications: Zero Skew, Low Skew, RJ45, UTP Based Video Application, Not for data transmission requiring TIA/EIA Category qualifications, RGB.

PART NUMBER	PRICE
C058D-XX-A-RD-7987R	\$3.00 + \$0.30/ft

VGA ADAPTER CABLE

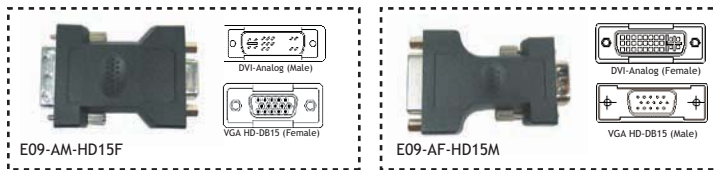

PART NUMBER	DESCRIPTION	1-24	25-49	50+
E09-AM-HD15F	DVI Analog Male to VGA HD-DB15 Female	\$7.92	7.56	7.02
E09-AF-HD15M	DVI Analog Female to VGA HD-DB15 Male	\$9.68	9.24	8.58

DISPLAYPORT ADAPTER

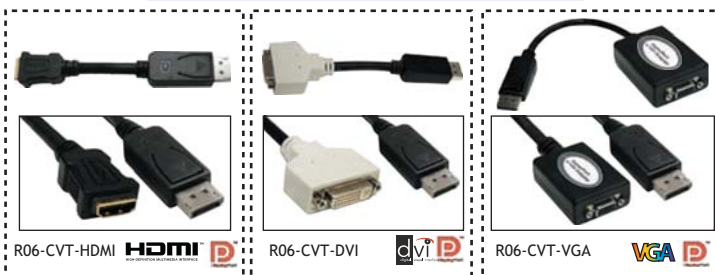

PART NUMBER	DESCRIPTION	1-24	25-49	50+
R06-CVT-HDMI	DisplayPort Male to HDMI Female Adapter	\$9.98	9.53	8.85
R06-CVT-DVI	DisplayPort Male to DVI Female Adapter	10.37	9.90	9.19
R06-CVT-VGA	DisplayPort Male to VGA Female Adapter	18.53	17.69	16.43

DISPLAYPORT CABLE



PART NUMBER	DESCRIPTION	1-24	25-49	50+
E12-DPM-DPM-06	DisplayPort Male to DisplayPort Male Cable, 6 feet	\$13.82	13.19	12.25
E12-DPM-DPM-10	DisplayPort Male to DisplayPort Male Cable, 10 feet	18.30	17.47	16.22
R06-CVT-HDMI-03	DisplayPort Male to HDMI Male Cable, 3 feet	11.32	10.80	10.03
R06-CVT-HDMI-06	DisplayPort Male to HDMI Male Cable, 6 feet	13.11	12.52	11.62
R06-CVT-HDMI-10	DisplayPort Male to HDMI Male Cable, 10 feet	15.29	14.60	13.56
R06-CVT-HDMI-15	DisplayPort Male to HDMI Male Cable, 15 feet	18.06	17.24	16.01
R06-CVT-DVI-03	DisplayPort Male to DVI Male Cable, 3 feet	11.60	11.07	10.28
R06-CVT-DVI-06	DisplayPort Male to DVI Male Cable, 6 feet	13.50	12.89	11.97
R06-CVT-DVI-10	DisplayPort Male to DVI Male Cable, 10 feet	16.07	15.34	14.24
R06-CVT-DVI-15	DisplayPort Male to DVI Male Cable, 15 feet	19.48	18.60	17.27
R06-CVT-VGA-03	DisplayPort Male to VGA Male Cable, 3 feet	20.24	19.32	17.94
R06-CVT-VGA-06	DisplayPort Male to VGA Male Cable, 6 feet	22.72	21.69	20.14
R06-CVT-VGA-10	DisplayPort Male to VGA Male Cable, 10 feet	26.05	24.86	23.09
R06-CVT-VGA-15	DisplayPort Male to VGA Male Cable, 15 feet	30.32	28.95	26.88

MINI DISPLAYPORT ADAPTER

MINI DISPLAYPORT MALE TO VGA FEMALE ADAPTER



R06-MDPM-VGAF-006

PART NUMBER	LENGTH	1-24	25-49	50+
R06-MDPM-VGAF-006	6 Inches	\$30.61	29.22	27.13

MINI DISPLAYPORT MALE TO HDMI FEMALE ADAPTER



R06-MDPM-HDMIF-006

PART NUMBER	LENGTH	1-24	25-49	50+
R06-MDPM-HDMIF-006	6 Inches	\$16.21	15.47	14.37

MINI DISPLAYPORT MALE TO DVI FEMALE ADAPTER



R06-MDPM-DVIF-006

PART NUMBER	LENGTH	1-24	25-49	50+
R06-MDPM-DVIF-006	6 Inches	\$16.07	15.34	14.24

MINI DISPLAYPORT CABLE

MINI DISPLAYPORT MALE TO DISPLAYPORT MALE CABLE



E12-MDPM-DPM-XX

PART NUMBER	LENGTH	1-24	25-49	50+
E12-MDPM-DPM-06	6 feet	\$12.62	12.05	11.19
E12-MDPM-DPM-10	10 feet	15.38	14.68	13.63

MINI DISPLAYPORT MALE TO MINI DISPLAYPORT MALE CABLE



E12-MDPM-MDPM-XX

PART NUMBER	LENGTH	1-24	25-49	50+
E12-MDPM-MDPM-06	6 feet	\$13.78	13.15	12.21
E12-MDPM-MDPM-10	10 feet	16.54	15.79	14.66

USB UTP EXTENDER

USB UTP EXTENDER (BOX STYLE AND WALL PLATE STYLE)

- Extends USB signal using regular CAT5/5e/6 cable up to 300 ft.
- Fully compliant with USB 1.1 specification
- Supports any full-speed or low-speed USB devices
- 100% compatible with USB hubs and other devices
- No software needed
- No power needed

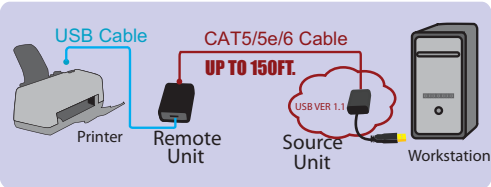

USB UTP EXTENDER 110 TYPE FACEPLATE



R04-EXT-C5E-FP

USB UTP EXTENDER BOX STYLE



R04-EXT-C5E-P

PART NUMBER	DESCRIPTION	1-4	5-9	10+
R04-EXT-C5E-FP	USB UTP Extender, 110 Type Wall Plate, 1 Set	\$40.00	38.75	37.50
R04-EXT-C5E-P	USB UTP Extender, Box Style, 1 Set	40.00	38.75	37.50

USB UTP EXTENDER/HUB

- Extends USB signal using CAT5/5E/6 UTP Cable
- Connects USB devices to one computer
- Fully compliant with USB 1.1 specification
- Supports any full-speed or low-speed USB devices
- Built-in 4 ports Hubs
- No software needed



R04-HUB-C5E-104A

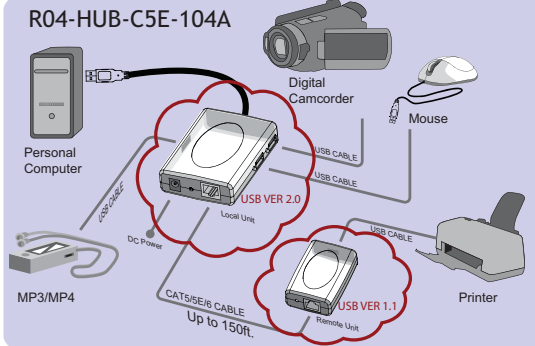

R04-HUB-C5E-104



R04-HUB-C5E-107

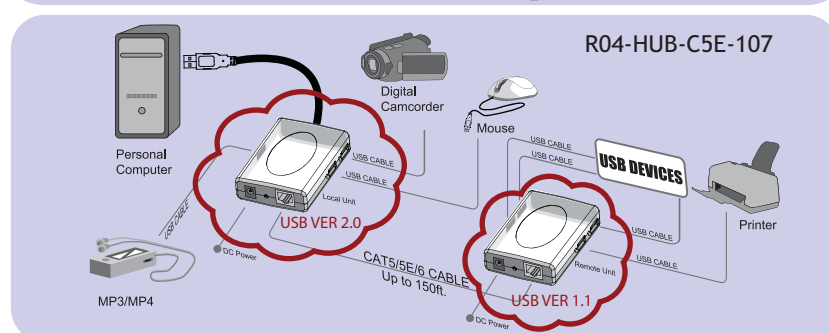
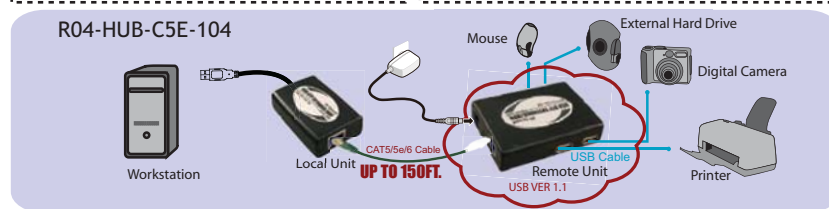

PART NUMBER	DESCRIPTION	1-4	5-9	10+
R04-HUB-C5E-104A	USB UTP Extender/Hub, 1 in 3 output on local unit, 1 output on remote unit	\$59.20	57.35	55.50
R04-HUB-C5E-104	USB UTP Extender/Hub, 1 in on local unit, 4 output on remote unit	59.20	57.35	55.50
R04-HUB-C5E-107	USB UTP Extender/Hub, 1 in 3 output on local unit, 4 output on remote unit	80.00	77.50	75.00



COMPOSITE VIDEO (YELLOW) + STEREO AUDIO (WHITE, RED)

BOX STYLE



R03-EXT-RWY (set of 2 pieces)
R03-EXT-RWY-S (1 piece)

FACEPLATE STYLE



R03-EXT-RWY-FP (set of 2 pieces)
R03-EXT-RWY-S (1 piece)

COMPONENT VIDEO (RED, GREEN, BLUE)

BOX STYLE



R03-EXT-RGB (set of 2 pieces)
R03-EXT-RGB-S (1 piece)

FACEPLATE STYLE



R03-EXT-RGB-FP (set of 2 pieces)
R03-EXT-RGB-FP-S (1 piece)

COMPONENT VIDEO (RED, GREEN, BLUE) + DIGITAL AUDIO (ORANGE)

BOX STYLE



R03-EXT-4RCA (set of 2 pieces)
R03-EXT-4RCA-S (1 piece)

FACEPLATE STYLE



R03-EXT-4RCA-FP (set of 2 pieces)
R03-EXT-4RCA-FP-S (1 piece)

S-VIDEO (MINI DIN 4) + STEREO AUDIO (WHITE, RED)

BOX STYLE



R03-EXT-MD4 (set of 2 pieces)
R03-EXT-MD4-S (1 piece)

FACEPLATE STYLE



R03-EXT-MD4-FP (set of 2 pieces)
R03-EXT-MD4-FP-S (1 piece)

COMPONENT VIDEO (RED, GREEN, BLUE) + STEREO AUDIO (RED, WHITE)

BOX STYLE



R03-EXT-5RCA (set of 2 pieces)
R03-EXT-5RCA-S (1 piece)

FACEPLATE STYLE



R03-EXT-5RCA-FP (set of 2 pieces)
R03-EXT-5RCA-FP-S (1 piece)

COMPONENT VIDEO (RED, GREEN, BLUE) BNC STYLE

BOX STYLE



R03-EXT-3BNC (set of 2 pieces)
R03-EXT-3BNC-S (1 piece)

FACEPLATE STYLE



R03-EXT-3BNC-FP (set of 2 pieces)
R03-EXT-3BNC-FP-S (1 piece)

SOLD AS SET (2 pieces)

PART NUMBER	DESCRIPTION	1-4	5-9	10+
R03-EXT-RWY	Composite Video + Stereo Audio, Box Style	\$34.80	33.71	32.63
R03-EXT-RWY-FP	Composite Video + Stereo Audio, Faceplate Style	28.80	27.90	27.00
R03-EXT-RGB	Component Video, Box Style	34.80	33.71	32.63
R03-EXT-RGB-FP	Component Video, Faceplate Style	28.80	27.90	27.00
R03-EXT-4RCA	Component Video + Digital Audio, Box Style	39.60	38.36	37.13
R03-EXT-4RCA-FP	Component Video + Digital Audio, Faceplate Style	33.60	32.55	31.50
R03-EXT-MD4	S-Video + Stereo Audio, Box Style	39.60	38.36	37.13
R03-EXT-MD4-FP	S-Video + Stereo Audio, Faceplate Style	33.60	32.55	31.50
R03-EXT-5RCA	Component Video + Stereo Audio, Box Style	39.60	38.36	37.13
R03-EXT-5RCA-FP	Component Video + Stereo Audio, Faceplate Style	33.60	32.55	31.50
R03-EXT-3BNC	Component Video BNC, Box Style	34.80	33.71	32.63
R03-EXT-3BNC-FP	Component Video BNC, Faceplate Style	28.80	27.90	27.00

SOLD SEPARATELY (1 piece)

PART NUMBER	DESCRIPTION	1-4	5-9	10+
R03-EXT-RWY-S	Composite Video + Stereo Audio, Box Style	\$17.44	16.90	16.35
R03-EXT-RWY-FP-S	Composite Video + Stereo Audio, Faceplate Style	14.40	13.95	13.50
R03-EXT-RGB-S	Component Video, Box Style	17.44	16.90	16.35
R03-EXT-RGB-FP-S	Component Video, Faceplate Style	14.40	13.95	13.50
R03-EXT-4RCA-S	Component Video + Digital Audio, Box Style	19.84	19.22	18.60
R03-EXT-4RCA-FP-S	Component Video + Digital Audio, Faceplate Style	16.80	16.28	15.75
R03-EXT-MD4-S	S-Video + Stereo Audio, Box Style	19.84	19.22	18.60
R03-EXT-MD4-FP-S	S-Video + Stereo Audio, Faceplate Style	16.80	16.28	15.75
R03-EXT-5RCA-S	Component Video + Stereo Audio, Box Style	19.84	19.22	18.60
R03-EXT-5RCA-FP-S	Component Video + Stereo Audio, Faceplate Style	16.80	16.28	15.75
R03-EXT-3BNC-S	Component Video BNC, Box Style	17.44	16.90	16.35
R03-EXT-3BNC-FP-S	Component Video BNC, Faceplate Style	14.40	13.95	13.50



UTP Cat5/5e/6 Cable Up to 300 feet @1080p

R03-EXT-RGB (Box Style as a set)

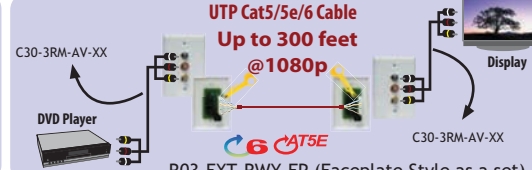

UTP Cat5/5e/6 Cable Up to 300 feet @1080p

R03-EXT-RWY-FP (Faceplate Style as a set)

RESOLUTION:

- 480p up to 500 feet
- 720p up to 400 feet
- 1080i up to 350 feet
- 1080/24p up to 300 feet
- 1080/60p up to 300 feet



COMPONENT/COMPOSITE VIDEO, STEREO AUDIO UTP EXTENDED 1x4 SPLITTER

COMPOSITE VIDEO (YELLOW) + STEREO AUDIO (WHITE, RED) 1x4 UTP SPLITTER

R03-SPL-C5E-RWY-104B



R02-SPL-PANEL

COMPONENT VIDEO (RED, GREEN, BLUE) + STEREO AUDIO (WHITE, RED) 1x4 UTP SPLITTER

R03-SPL-C5E-5RCA-104B



R02-SPL-PANEL

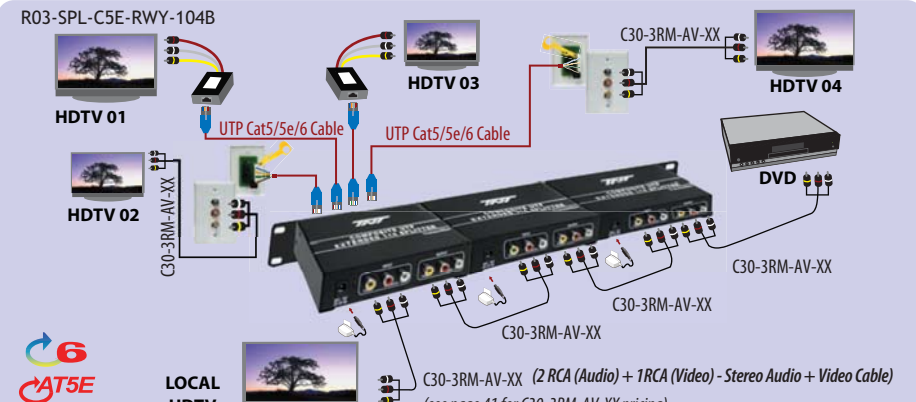

R03-SPL-C5E-RWY-104B

HDTV 01, HDTV 02, HDTV 03, HDTV 04

LOCAL HDTV

DVD

UTP Cat5/5e/6 Cable

C30-3RM-AV-XX (2 RCA (Audio) + 1RCA (Video) - Stereo Audio + Video Cable)

(see page 41 for C30-3RM-AV-XX pricing)

PART NUMBER	DESCRIPTION	1-4	5-9	10+
R03-SPL-C5E-RWY-104B	Composite Video + Stereo Audio 1x4 UTP Splitter	\$65.60	63.55	61.50
R03-SPL-C5E-5RCA-104B	Component Video + Stereo Audio 1x4 UTP Splitter	92.80	89.90	87.00
R02-SPL-PANEL	1U 19" Rack Mountable Panel, up to 3 Splitters	30.40	29.45	28.50

KVM/UVM UTP EXTENDER OVER ONE CAT5/6 CABLE

- Provides convenient dual access for KVM console
- High resolution up to 1920x1440@60Hz
- Only ONE UTP Cable needed for one remote location
- Distance up to 500ft. apart
- Work with monitors, projectors, HDTV and flat panels



Detachable Mounting Brackets are included



Local (front side)

R07-EXT-C5E



Local (back side)



Remote (front side)



Remote (back side)

USB A to USB B Cable

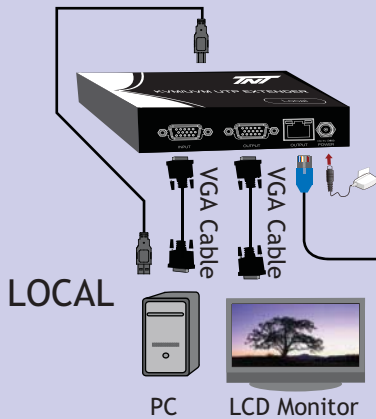

LOCAL

PC

LCD Monitor

LCD Monitor



Keyboard



Mouse



VGA Cable

Cat5/5e/6 Cable

Up to 500 ft

REMOTE

PART NUMBER	DESCRIPTION	1-4	5-9	10+
R07-EXT-C5E	KVM Switch UTP Extender over 1x Cat5/5e/6 Cable, sold as a set (Local & Remote)	\$168.00	162.75	157.50

RS-232 UTP EXTENDER OVER ONE CAT5/6 CABLE

- Extend RS-232 signal using ONE UTP Cable
- Distance up to 1000 ft.
- Works with scanner and touch screen control.
- The units are bi-directional.
- Connectors: Receiver: DB9 Female, RJ45 input, Power; Transmitter: DB9 Female, RJ45 output, Power.



R08-EXT-C5E



Receiver



Transmitter

DB9 pin to pin cable

Bar Code Scanner or Touch Screen

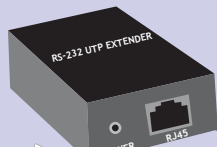

RECEIVER

AC/DC Power Adapter

DB9 pin to pin cable

Workstation

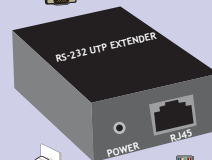

TRANSMITTER

AC/DC Power Adapter

PART NUMBER	DESCRIPTION	1-4	5-9	10+
R08-EXT-C5E	RS-232 UTP Extender over 1x Cat5/5e/6 Cable, sold as a set (Transmitter & Receiver)	\$38.80	37.59	36.38

- Connector: ST, SC, LC, FC or MTRJ; cables with other types of connectors are available upon request.
- Cable: 9µm/125µm, PVC fiber zipcord (duplex), single-mode, **YELLOW** color.



ST to ST, DUPLEX, SINGLE-MODE

ORDER CODE	LENGTH	1-24	25-49	50+
800-DST-DST-S-1M	1 Meter	\$19.89	18.98	17.63
800-DST-DST-S-2M	2 Meters	20.77	19.82	18.41
800-DST-DST-S-3M	3 Meters	21.65	20.66	19.19
800-DST-DST-S-5M	5 Meters	23.41	22.34	20.75
800-DST-DST-S-10M	10 Meters	27.81	26.54	24.65
800-DST-DST-S-15M	15 Meters	32.21	30.74	28.55

• Custom Length: \$20.00 + \$1.00/Meter



LC to ST, DUPLEX, SINGLE-MODE

ORDER CODE	LENGTH	1-24	25-49	50+
800-DLC-DST-S-1M	1 Meter	\$22.53	21.50	19.97
800-DLC-DST-S-2M	2 Meters	23.41	22.34	20.75
800-DLC-DST-S-3M	3 Meters	24.29	23.18	21.53
800-DLC-DST-S-5M	5 Meters	26.05	24.86	23.09
800-DLC-DST-S-10M	10 Meters	30.45	29.06	26.99
800-DLC-DST-S-15M	15 Meters	34.85	33.26	30.89

• Custom Length: \$22.00 + \$1.00/Meter

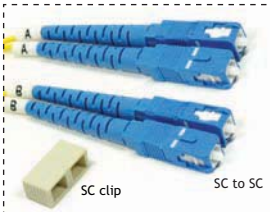

SC to SC, DUPLEX, SINGLE-MODE

ORDER CODE	LENGTH	1-24	25-49	50+
800-DSC-DSC-S-1M	1 Meter	\$19.89	18.98	17.63
800-DSC-DSC-S-2M	2 Meters	20.77	19.82	18.41
800-DSC-DSC-S-3M	3 Meters	21.65	20.66	19.19
800-DSC-DSC-S-5M	5 Meters	23.41	22.34	20.75
800-DSC-DSC-S-10M	10 Meters	27.81	26.54	24.65
800-DSC-DSC-S-15M	15 Meters	32.21	30.74	28.55

• Custom Length: \$20.00 + \$1.00/Meter

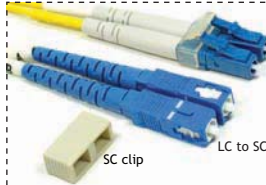

LC to SC, DUPLEX, SINGLE-MODE

ORDER CODE	LENGTH	1-24	25-49	50+
800-DLC-DSC-S-1M	1 Meter	\$22.53	21.50	19.97
800-DLC-DSC-S-2M	2 Meters	23.41	22.34	20.75
800-DLC-DSC-S-3M	3 Meters	24.29	23.18	21.53
800-DLC-DSC-S-5M	5 Meters	26.05	24.86	23.09
800-DLC-DSC-S-10M	10 Meters	30.45	29.06	26.99
800-DLC-DSC-S-15M	15 Meters	34.85	33.26	30.89

• Custom Length: \$22.00 + \$1.00/Meter

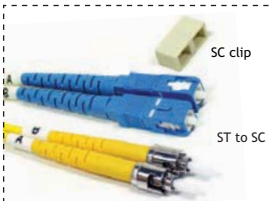

ST to SC, DUPLEX, SINGLE-MODE

ORDER CODE	LENGTH	1-24	25-49	50+
800-DST-DSC-S-1M	1 Meter	\$19.89	18.98	17.63
800-DST-DSC-S-2M	2 Meters	20.77	19.82	18.41
800-DST-DSC-S-3M	3 Meters	21.65	20.66	19.19
800-DST-DSC-S-5M	5 Meters	23.41	22.34	20.75
800-DST-DSC-S-10M	10 Meters	27.81	26.54	24.65
800-DST-DSC-S-15M	15 Meters	32.21	30.74	28.55

• Custom Length: \$20.00 + \$1.00/Meter



LC to LC, DUPLEX, SINGLE-MODE

ORDER CODE	LENGTH	1-24	25-49	50+
800-DLC-DLC-S-1M	1 Meter	\$25.52	24.36	22.62
800-DLC-DLC-S-2M	2 Meters	26.40	25.20	23.40
800-DLC-DLC-S-3M	3 Meters	27.28	26.04	24.18
800-DLC-DLC-S-5M	5 Meters	29.04	27.72	25.74
800-DLC-DLC-S-10M	10 Meters	33.44	31.92	29.64
800-DLC-DLC-S-15M	15 Meters	37.84	36.12	33.54

• Custom Length: \$25.00 + \$1.00/Meter



MTRJ to ST, DUPLEX, SINGLE-MODE

ORDER CODE	LENGTH	1-24	25-49	50+
800-MTRJ-ST-S-XX	XX = Length of Cable in Meter			

• Custom Length: \$22.00 + \$1.00/Meter



FC to ST, DUPLEX, SINGLE-MODE

ORDER CODE	LENGTH
800-DFC-DST-S-XX	XX = Length of Cable in Meter

• Custom Length: \$20.00 + \$1.00/Meter

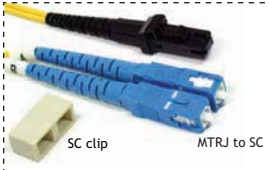

MTRJ to SC, DUPLEX, SINGLE-MODE

ORDER CODE	LENGTH	1-24	25-49	50+
800-MTRJ-SC-S-XX	XX = Length of Cable in Meter			

• Custom Length: \$22.00 + \$1.00/Meter



FC to SC, DUPLEX, SINGLE-MODE

ORDER CODE	LENGTH
800-DFC-DSC-S-XX	XX = Length of Cable in Meter

• Custom Length: \$20.00 + \$1.00/Meter



MTRJ to LC, DUPLEX, SINGLE-MODE

ORDER CODE	LENGTH	1-24	25-49	50+
800-MTRJ-LC-S-XX	XX = Length of Cable in Meter			

• Custom Length: \$25.00 + \$1.00/Meter

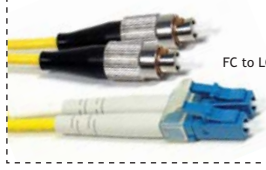

FC to LC, DUPLEX, SINGLE-MODE

ORDER CODE	LENGTH
800-DFC-DLC-S-XX	XX = Length of Cable in Meter

• Custom Length: \$22.00 + \$1.00/Meter



MTRJ to MTRJ, DUPLEX, SINGLE-MODE

ORDER CODE	LENGTH	1-9	10-19	20+
800-MTRJ-MTRJ-S-XX	XX = Length of Cable in Meter			

• Custom Length: \$23.00 + \$1.00/Meter

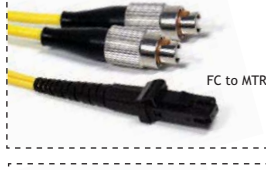

FC to MTRJ, DUPLEX, SINGLE-MODE

ORDER CODE	LENGTH
800-DFC-MTRJ-S-XX	XX = Length of Cable in Meter

• Custom Length: \$22.00 + \$1.00/Meter

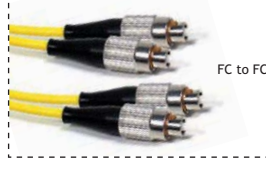

FC to FC, DUPLEX, SINGLE-MODE

ORDER CODE	LENGTH
800-DFC-DFC-S-XX	XX = Length of Cable in Meter

• Custom Length: \$20.00 + \$1.00/Meter

FIBER OPTIC CABLE DUST COVERS

- Protect fiber connector ferrule from dust or scratch of the glass surface.
- Unique attachment design - Dust cover attached and tied to the fiber cable so it doesn't get lost while handling.
- Cover the ferrule for LC, MU, SC, ST and FC connectors.
- P60 PVC material - never damage the ferrule.
- Available in 9 colors.



XX = Color
WH = White
GY = Gray
BK = Black
BL = Blue
GN = Green
RD = Red
OR = Orange
YL = Yellow
IV = Ivory

ORDER CODE	DESCRIPTION	1-9	10-19	20+
895-DC-LM-XX	Dust cover for LC or MU connector, 50pcs/pk	\$11.44	10.92	10.14
895-DC-TCF-XX	Dust cover for ST, SC, or FC connector 50pcs/pk	11.44	10.92	10.14



- Connector: ST, SC, LC, FC or MTRJ; Cables with other types of connectors are available upon request.
- Cable: 62.5µm/125µm, PVC fiber zipcord (duplex), multi-mode, **ORANGE** color.
- Also available in **White, Gray, Purple, Brown, Red, Blue, Green, Pink, and Yellow** color.

ST to ST, DUPLEX, MULTI-MODE

ORDER CODE	LENGTH	1-24	25-49	50+
800-DST-DST-M-1M	1 Meter	\$16.90	16.13	14.98
800-DST-DST-M-2M	2 Meters	17.95	17.14	15.91
800-DST-DST-M-3M	3 Meters	19.01	18.14	16.85
800-DST-DST-M-5M	5 Meters	21.12	20.16	18.72
800-DST-DST-M-10M	10 Meters	26.40	25.20	23.40
800-DST-DST-M-15M	15 Meters	31.68	30.24	28.08

• Custom Length: \$16.00 + \$1.10/Meter

ST to ST



LC to ST, DUPLEX, MULTI-MODE

ORDER CODE	LENGTH	1-24	25-49	50+
800-DLC-DST-M-1M	1 Meter	\$20.42	19.49	18.10
800-DLC-DST-M-2M	2 Meters	21.47	20.50	19.03
800-DLC-DST-M-3M	3 Meters	22.53	21.50	19.97
800-DLC-DST-M-5M	5 Meters	24.64	23.52	21.84
800-DLC-DST-M-10M	10 Meters	29.92	28.56	26.52
800-DLC-DST-M-15M	15 Meters	35.20	33.60	31.20

• Custom Length: \$20.00 + \$1.10/Meter

LC to ST



SC to SC, DUPLEX, MULTI-MODE

ORDER CODE	LENGTH	1-24	25-49	50+
800-DSC-DSC-M-1M	1 Meter	\$18.66	17.81	16.54
800-DSC-DSC-M-2M	2 Meters	19.71	18.82	17.47
800-DSC-DSC-M-3M	3 Meters	20.77	19.82	18.41
800-DSC-DSC-M-5M	5 Meters	22.88	21.84	20.28
800-DSC-DSC-M-10M	10 Meters	28.16	26.88	24.96
800-DSC-DSC-M-15M	15 Meters	33.44	31.92	29.64

• Custom Length: \$18.00 + \$1.10/Meter

SC clip

SC to SC

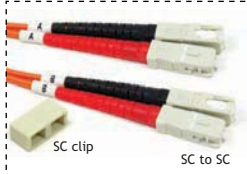

LC to SC, DUPLEX, MULTI-MODE

ORDER CODE	LENGTH	1-24	25-49	50+
800-DLC-DSC-M-1M	1 Meter	\$20.42	19.49	18.10
800-DLC-DSC-M-2M	2 Meters	21.47	20.50	19.03
800-DLC-DSC-M-3M	3 Meters	22.53	21.50	19.97
800-DLC-DSC-M-5M	5 Meters	24.64	23.52	21.84
800-DLC-DSC-M-10M	10 Meters	29.92	28.56	26.52
800-DLC-DSC-M-15M	15 Meters	35.20	33.60	31.20

• Custom Length: \$20.00 + \$1.10/Meter

LC to SC

SC clip

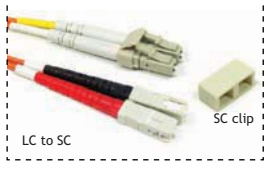

ST to SC, DUPLEX, MULTI-MODE

ORDER CODE	LENGTH	1-24	25-49	50+
800-DST-DSC-M-1M	1 Meter	\$17.95	17.14	15.91
800-DST-DSC-M-2M	2 Meters	19.01	18.14	16.85
800-DST-DSC-M-3M	3 Meters	20.06	19.15	17.78
800-DST-DSC-M-5M	5 Meters	22.18	21.17	19.66
800-DST-DSC-M-10M	10 Meters	27.46	26.21	24.34
800-DST-DSC-M-15M	15 Meters	32.74	31.25	29.02

• Custom Length: \$17.00 + \$1.10/Meter

SC clip

ST to SC



LC to LC, DUPLEX, MULTI-MODE

ORDER CODE	LENGTH	1-24	25-49	50+
800-DLC-DLC-M-1M	1 Meter	\$21.82	20.83	19.34
800-DLC-DLC-M-2M	2 Meters	22.88	21.84	20.28
800-DLC-DLC-M-3M	3 Meters	23.94	22.85	21.22
800-DLC-DLC-M-5M	5 Meters	26.05	24.86	23.09
800-DLC-DLC-M-10M	10 Meters	31.33	29.90	27.77
800-DLC-DLC-M-15M	15 Meters	36.61	34.94	32.45

• Custom Length: \$21.00 + \$1.10/Meter

LC to LC



MTRJ to DUPLEX ST, MULTI-MODE

ORDER CODE	LENGTH	1-24	25-49	50+
800-MTRJ-ST-M-1M	1 Meter	\$17.60	16.80	15.60
800-MTRJ-ST-M-2M	2 Meters	18.66	17.81	16.54
800-MTRJ-ST-M-3M	3 Meters	19.71	18.82	17.47
800-MTRJ-ST-M-5M	5 Meters	21.82	20.83	19.34
800-MTRJ-ST-M-10M	10 Meters	27.10	25.87	24.02
800-MTRJ-ST-M-15M	15 Meters	32.38	30.91	28.70

• Custom Length: \$16.70 + \$1.10/Meter

MTRJ to ST



LC to MTRJ, DUPLEX, MULTI-MODE

ORDER CODE	LENGTH	1-24	25-49	50+
800-DLC-MTRJ-M-1M	1 Meter	\$22.35	21.34	19.81
800-DLC-MTRJ-M-2M	2 Meters	23.41	22.34	20.75
800-DLC-MTRJ-M-3M	3 Meters	24.46	23.35	21.68
800-DLC-MTRJ-M-5M	5 Meters	26.58	25.37	23.56
800-DLC-MTRJ-M-10M	10 Meters	31.86	30.41	28.24
800-DLC-MTRJ-M-15M	15 Meters	37.14	35.45	32.92

• Custom Length: \$22.00 + \$1.10/Meter

LC to MTRJ



MTRJ to DUPLEX SC, MULTI-MODE

ORDER CODE	LENGTH	1-24	25-49	50+
800-MTRJ-SC-M-1M	1 Meter	\$17.95	17.14	15.91
800-MTRJ-SC-M-2M	2 Meters	19.01	18.14	16.85
800-MTRJ-SC-M-3M	3 Meters	20.06	19.15	17.78
800-MTRJ-SC-M-5M	5 Meters	22.18	21.17	19.66
800-MTRJ-SC-M-10M	10 Meters	27.46	26.21	24.34
800-MTRJ-SC-M-15M	15 Meters	32.74	31.25	29.02

• Custom Length: \$17.00 + \$1.10/Meter

SC clip

MTRJ to SC

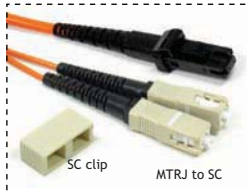

MTRJ to MTRJ, MULTI-MODE

ORDER CODE	LENGTH	1-24	25-49	50+
800-MTRJ-MTRJ-M-1M	1 Meter	\$18.66	17.81	16.54
800-MTRJ-MTRJ-M-2M	2 Meters	19.71	18.82	17.47
800-MTRJ-MTRJ-M-3M	3 Meters	20.77	19.82	18.41
800-MTRJ-MTRJ-M-5M	5 Meters	22.88	21.84	20.28
800-MTRJ-MTRJ-M-10M	10 Meters	28.16	26.88	24.96
800-MTRJ-MTRJ-M-15M	15 Meters	33.44	31.92	29.64

• Custom Length: \$18.00 + \$1.10/Meter

MTRJ to MTRJ



FC to FC, DUPLEX, MULTI-MODE

ORDER CODE	LENGTH
800-DFC-DFC-M-XX	XX = Length of Cable in Meter

• Custom Length: \$18.00 + \$1.10/Meter

FC to FC

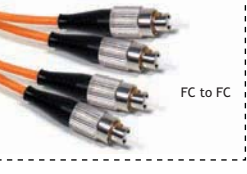

FC to SC, DUPLEX, MULTI-MODE

ORDER CODE	LENGTH
800-DFC-DSC-M-XX	XX = Length of Cable in Meter

• Custom Length: \$18.00 + \$1.10/Meter

FC to SC

SC clip

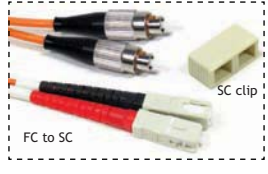

FC to LC, DUPLEX, MULTI-MODE

ORDER CODE	LENGTH
800-DFC-DLC-M-XX	XX = Length of Cable in Meter

• Custom Length: \$20.00 + \$1.10/Meter

FC to LC



FC to ST, DUPLEX, MULTI-MODE

ORDER CODE	LENGTH
800-DFC-DST-M-XX	XX = Length of Cable in Meter

• Custom Length: \$17.00 + \$1.10/Meter

FC to ST



FC to MTRJ, DUPLEX, MULTI-MODE

ORDER CODE	LENGTH
800-DFC-MTRJ-M-XX	XX = Length of Cable in Meter

• Custom Length: \$17.00 + \$1.10/Meter

FC to MTRJ



** MU, FDDI, and ESCON Assembly Available Upon Request **



50/125 MULTI-MODE CABLES

- Cable: 50µm/125µm, PVC fiber zipcord (duplex), multi-mode, **ORANGE** color.
- Cables with other types of connectors are available upon request.
- Also available in **White, Gray, Purple, Brown, Red, Blue, Green, Pink,** and **Yellow** color.

** Also available in FC and MTRJ related cable assembly. **



ST to SC, DUPLEX, MULTI-MODE

ORDER CODE	LENGTH	1-24	25-49	50+
800-DST-DSC-5M-1M	1 Meter	\$17.95	17.14	15.91
800-DST-DSC-5M-2M	2 Meters	19.01	18.14	16.85
800-DST-DSC-5M-3M	3 Meters	20.06	19.15	17.78
800-DST-DSC-5M-5M	5 Meters	22.18	21.17	19.66
800-DST-DSC-5M-10M	10 Meters	27.46	26.21	24.34

• Custom Length: \$17.00 + \$1.10/Meter



LC to SC, DUPLEX, MULTI-MODE

ORDER CODE	LENGTH
800-DLC-DSC-5M-XX	XX = Length of Cable in Meter

• Custom Length: \$20.00 + \$1.10/Meter

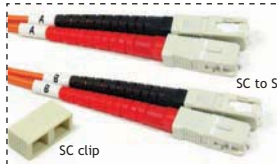

SC to SC, DUPLEX, MULTI-MODE

ORDER CODE	LENGTH	1-24	25-49	50+
800-DSC-DSC-5M-1M	1 Meter	\$18.66	17.81	16.54
800-DSC-DSC-5M-2M	2 Meters	19.71	18.82	17.47
800-DSC-DSC-5M-3M	3 Meters	20.77	19.82	18.41
800-DSC-DSC-5M-5M	5 Meters	22.88	21.84	20.28
800-DSC-DSC-5M-10M	10 Meters	28.16	26.88	24.96

• Custom Length: \$18.00 + \$1.10/Meter



LC to ST, DUPLEX, MULTI-MODE

ORDER CODE	LENGTH
800-DLC-DST-5M-XX	XX = Length of Cable in Meter

• Custom Length: \$20.00 + \$1.10/Meter



ST to ST, DUPLEX, MULTI-MODE

ORDER CODE	LENGTH
800-DST-DST-5M-XX	XX = Length of Cable in Meter

• Custom Length: \$16.00 + \$1.10/Meter

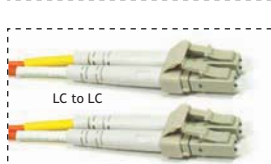

LC to LC, DUPLEX, MULTI-MODE

ORDER CODE	LENGTH
800-DLC-DLC-5M-XX	XX = Length of Cable in Meter

• Custom Length: \$21.00 + \$1.10/Meter

50/125 10Gbps FIBER CABLES

- LSZH (Low Smoke Zero Halogen) cable.
- Design for 10 Gbps Ethernet application to 300 meters.
- For use at 850 nm and 1300 nm, 50/125 multi-mode, **AQUA** color.

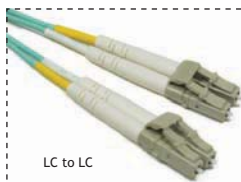

LC to LC, DUPLEX, MULTI-MODE

ORDER CODE	LENGTH	1-24	25-49	50+
800G-DLC-DLC-5M-1M	1 Meter	\$22.18	21.17	19.66
800G-DLC-DLC-5M-2M	2 Meters	23.58	22.51	20.90
800G-DLC-DLC-5M-3M	3 Meters	24.99	23.86	22.15
800G-DLC-DLC-5M-5M	5 Meters	27.81	26.54	24.65
800G-DLC-DLC-5M-10M	10 Meters	34.85	33.26	30.89

• Custom Length: \$21.00 + \$1.50/Meter

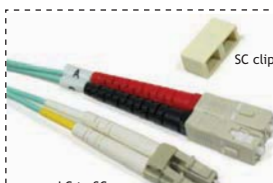

LC to SC, DUPLEX, MULTI-MODE

ORDER CODE	LENGTH	1-24	25-49	50+
800G-DLC-DSC-5M-1M	1 Meter	\$20.77	19.82	18.41
800G-DLC-DSC-5M-2M	2 Meters	22.18	21.17	19.66
800G-DLC-DSC-5M-3M	3 Meters	23.58	22.51	20.90
800G-DLC-DSC-5M-5M	5 Meters	26.40	25.20	23.40
800G-DLC-DSC-5M-10M	10 Meters	33.44	31.92	29.64

• Custom Length: \$20.00 + \$1.50/Meter

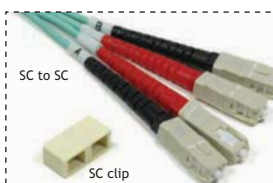

SC to SC, DUPLEX, MULTI-MODE

ORDER CODE	LENGTH	1-24	25-49	50+
800G-DSC-DSC-5M-1M	1 Meter	\$19.01	18.14	16.85
800G-DSC-DSC-5M-2M	2 Meters	20.42	19.49	18.10
800G-DSC-DSC-5M-3M	3 Meters	21.82	20.83	19.34
800G-DSC-DSC-5M-5M	5 Meters	24.64	23.52	21.84
800G-DSC-DSC-5M-10M	10 Meters	31.68	30.24	28.08

• Custom Length: \$18.00 + \$1.50/Meter



** Also available in ST, FC, and MTRJ related cable assembly **

DISTRIBUTION UNITS

WALL-MOUNT DISTRIBUTION ENCLOSURE

- Heavy-duty 16-gauge steel.
- Top and bottom entry holes.
- Dust-proof grommets.
- Cable routing accessories.
- Size: 10" x 12" x 3 1/4".
- Adapter panels to be ordered separately
 - * 12-port requires 2 panels.
 - * 24-port requires 4 panels.



ORDER CODE	DESCRIPTION	1-9	10-19	20+
892-12	12 Ports	\$68.64	65.52	60.84
892-24	24 Ports	77.44	73.92	68.64

BULKHEAD CUTOUT PANELS

- Interchangeable panel for Wall Mount or Rack Mount Distribution Units.

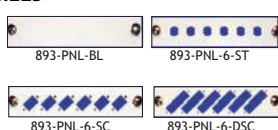

ORDER CODE	DESCRIPTION	1-9	10-19	20+
893-PNL-BL	Blank Panel, No cutout	\$6.42	6.13	5.69
893-PNL-6-ST	6 x simplex ST bulkhead cutouts	6.42	6.13	5.69
893-PNL-6-SC	6 x simplex SC, 6 x MTRJ, or 6 x duplex LC bulkhead cutouts	6.42	6.13	5.69
893-PNL-6-DSC	6 x duplex SC bulkhead cutouts or 6 x duplex ST bulkhead cutouts	6.42	6.13	5.69

LOCKED WALL-MOUNT DISTRIBUTION ENCLOSURE

- Heavy-duty 16-gauge steel.
- Top and bottom entry holes.
- Padlock hasp allows entry unit to be locked.
- Size: 12" x 10 7/8" x 4".
- Double metal door with lock and key.
- Interchangeable adapter panels to be ordered separately
 - * 12-port requires 2 panels.
 - * 24-port requires 4 panels.



ORDER CODE	DESCRIPTION	1-9	10-19	20+
892-12-LOCK	12 Ports Locked	\$140.80	134.40	124.80
892-24-LOCK	24 Ports Locked	149.60	142.80	132.60

6-PORT ADAPTER PANELS WITH COUPLINGS LOADED

- Interchangeable panel for Wall Mount or Rack Mount Distribution Units. Loaded with multi-mode couplings.

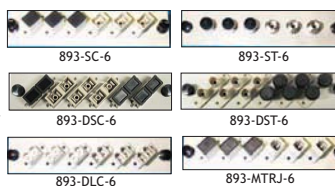

ORDER CODE	DESCRIPTION	1-9	10-19	20+
893-SC-6	6 x Simplex SC/SC	\$22.26	21.25	19.73
893-ST-6	6 x Simplex ST/ST	22.26	21.25	19.73
893-DSC-6	6 x Duplex SC/SC	32.12	30.66	28.47
893-DST-6	6 x Duplex ST/ST	32.12	30.66	28.47
893-DLC-6	6 x Duplex LC/LC	32.12	30.66	28.47
893-MTRJ-6	6 x MTRJ	22.26	21.25	19.73

19" OR 23" RACK-MOUNT ENCLOSURE

- Heavy-duty 16-gauge steel.
- Unique mounting brackets designed to work with both 19" and 23" rack.
- Slide-out drawer provides front access.
- Interchangeable adapter panels to be ordered separately.
- 12-port requires 2 panels.

ORDER CODE	# PORTS	SIZE	UNIT PRICE
893-12	12		\$126.72



FIBER PANELS

- Loaded with multi-mode bulkhead.
- Single-mode panels are available upon request.

19" RACK MOUNT PANEL LOADED WITH DUPLEX ST BULKHEAD

ORDER CODE	# OF PORT	HEIGHT	1-9	10-19	20+
891-DST-12-L	12	1 3/4"	\$68.64	65.52	60.84
891-DST-16-L	16	1 3/4"	86.24	82.32	76.44
891-DST-24-L	24	1 3/4"	121.44	115.92	107.64
891-DST-32-L	32	3 1/2"	158.40	151.20	140.40
891-DST-48-L	48	3 1/2"	228.80	218.40	202.80



19" RACK MOUNT PANEL LOADED WITH SIMPLEX ST BULKHEAD

ORDER CODE	# OF ST	HEIGHT	1-9	10-19	20+
891-ST-12-L	12	1 3/4"	\$47.52	45.36	42.12
891-ST-16-L	16	1 3/4"	58.08	55.44	51.48
891-ST-24-L	24	3 1/2"	79.20	75.60	70.20
891-ST-32-L	32	3 1/2"	102.08	97.44	90.48



19" RACK MOUNT PANEL LOADED WITH DUAL SC BULKHEAD

ORDER CODE	# OF DUAL SC	HEIGHT	1-9	10-19	20+
891-DSC-12-L	12	1 3/4"	\$68.64	65.52	60.84
891-DSC-16-L	16	1 3/4"	86.24	82.32	76.44
891-DSC-24-L	24	1 3/4"	121.44	115.92	107.64
891-DSC-32-L	32	3 1/2"	158.40	151.20	140.40
891-DSC-48-L	48	3 1/2"	228.80	218.40	202.80



19" RACK MOUNT PANEL LOADED WITH DUPLEX LC BULKHEADS

ORDER CODE	# OF PORT	HEIGHT	1-9	10-19	20+
891-DLC-08-L	8	1 3/4"	\$52.80	50.40	46.80
891-DLC-12-L	12	1 3/4"	68.64	65.52	60.84
891-DLC-16-L	16	1 3/4"	86.24	82.32	76.44
891-DLC-24-L	24	3 1/2"	121.44	115.92	107.64
891-DLC-32-L	32	3 1/2"	158.40	151.20	140.40
891-DLC-48-L	48	5 1/4"	228.80	218.40	202.80

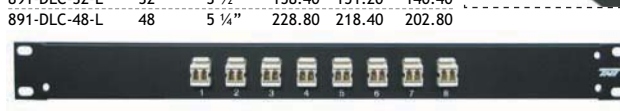

MTRJ 19" RACK MOUNT FEED THRU PANEL

ORDER CODE	# OF MTRJ	HEIGHT	1-9	10-19	20+
891-MTRJ-08-L	8	1 3/4"	\$41.17	39.30	36.49
891-MTRJ-12-L	12	1 3/4"	48.10	45.91	42.63
891-MTRJ-16-L	16	1 3/4"	58.08	55.44	51.48
891-MTRJ-24-L	24	3 1/2"	79.20	75.60	70.20
891-MTRJ-32-L	32	3 1/2"	102.08	97.44	90.48
891-MTRJ-48-L	48	5 1/4"	146.08	139.44	129.48

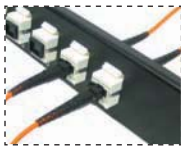

19" RACK MOUNT PANEL LOADED WITH DUPLEX ST TO SC ADAPTERS

ORDER CODE	# OF PORT	HEIGHT	1-9	10-19	20+
891-DST/DSC-12-L	12	1 3/4"	\$68.64	65.52	60.84
891-DST/DSC-16-L	16	1 3/4"	86.24	82.32	76.44
891-DST/DSC-24-L	24	1 3/4"	121.44	115.92	107.64
891-DST/DSC-32-L	32	3 1/2"	158.40	151.20	140.40
891-DST/DSC-48-L	48	3 1/2"	228.80	218.40	202.80

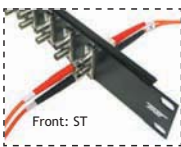

ACCESSORIES

ST, SC, LC, MTRJ FEMALE / FEMALE BULKHEAD COUPLING / ADAPTER

- Free-hanging connection or panel feed-through mountable.
- High precision mating structure and low insertion loss.
- Dust cap included.



ORDER CODE	DESCRIPTION	1-49	50-99	100+
Multi-Mode Coupling				
890-ST-ST-M	Simplex Multi-Mode ST to ST Bulkhead Coupling	\$2.46	2.35	2.18
890-SC-SC-M	Simplex Multi-Mode SC to SC Bulkhead Coupling	2.46	2.35	2.18
890-DST-DST-M	Duplex Multi-Mode ST to ST Bulkhead Coupling	3.43	3.28	3.04
890-DSC-DSC-M	Duplex Multi-Mode SC to SC Bulkhead Coupling	3.43	3.28	3.04
890-DLC-DLC-M	Duplex Multi-Mode LC to LC Bulkhead Coupling	3.43	3.28	3.04
890-MTRJ-MTRJ-M	Multi-Mode MT-RJ to MT-RJ Mating Coupler, Panel Mountable	4.40	4.20	3.90
Multi-Mode Adapter				
890-ST-SC-M	Simplex ST to SC Multi-Mode Adapter	2.46	2.35	2.18
890-DST-DSC-M	Duplex ST to SC Multi-Mode Adapter	3.43	3.28	3.04
For Both Multi-Mode and Single-Mode				
890-ST-ST-S	Simplex ST to ST Bulkhead Coupling	4.93	4.70	4.37
890-SC-SC-S	Simplex SC to SC Bulkhead Coupling	3.70	3.53	3.28
890-DSC-DSC-S	Duplex SC to SC Bulkhead Coupling	6.86	6.55	6.08
890-DLC-DLC-S	Duplex LC to LC Bulkhead Coupling	6.86	6.55	6.08

FIBER OPTIC LOOPBACK CABLES

- Provides a looped (circular) signal from source device to hardware for testing purposes, enabling a signal check for both transmit and receiving function.
- Available in SC, LC, MTRJ types, Multi-Mode or Single-Mode.
- Multimode cable in 62.5/125µ, 50/125µ, or 10G 50/125µ.
- Cable Length: 3 inches.



ORDER CODE	DESCRIPTION	1-24	25-49	50+
800-LP-SC-M50	Multi-Mode, 50/125, SC	\$13.20	12.60	11.70
800-LP-LC-M50	Multi-Mode, 50/125, LC	13.20	12.60	11.70
800-LP-MTRJ-50	Multi-Mode, 50/125, MTRJ	13.20	12.60	11.70
800-LP-SC-M62.5	Multi-Mode, 62.5/125, SC	13.20	12.60	11.70
800-LP-LC-M62.5	Multi-Mode, 62.5/125, LC	13.20	12.60	11.70
800-LP-MTRJ-62.5	Multi-Mode, 62.5/125, MTRJ	13.20	12.60	11.70
800-LP-SC-S	Single-Mode, SC	14.08	13.44	12.48
800-LP-LC-S	Single-Mode, LC	14.08	13.44	12.48
800-LP-MTRJ-S	Single-Mode, MTRJ	14.08	13.44	12.48
800G-LP-SC-M50	10Gigabit Multi-Mode, 50/125, SC	13.20	12.60	11.70
800G-LP-LC-M50	10Gigabit Multi-Mode, 50/125, LC	13.20	12.60	11.70
800G-LP-MTRJ-50	10Gigabit Multi-Mode, 50/125, MTRJ	13.20	12.60	11.70

DUST COVER FOR LC/SC COUPLER

- Protect fiber optic couplers from dust.
- Protect the un-used ports on the fiber optic patch panels.
- Unique hinge style design.
- For LC or SC couplers.
- Colors available in BLUE and IVORY.



ORDER CODE	DESCRIPTION	1-49	50-99	100+
895-DLC-SHUTTER-XX	Dust Cover for LC duplex coupler	\$0.53	0.50	0.47
895-DSC-SHUTTER-XX	Dust Cover for SC duplex coupler	0.53	0.50	0.47

XX = Color BL IV

FIBER SC SINGLE-MODE PLUG TYPE ATTENUATORS

- Stable and accurate attenuation value.
- Low back reflection.
- Single-mode type.
- Bi-directional, Non air gap.
- Zirconia ferrule and split sleeve.
- Dust caps included.
- Bellcore Standard GR-326-CORE compliant.
- Other attenuator values are available upon request.



ORDER CODE	DESCRIPTION	1-24	25-49	50+
870-SC-MF-S-05	SC Single-Mode Male to Female Attenuator, 5 dB	\$34.85	33.26	30.89
870-SC-MF-S-10	SC Single-Mode Male to Female Attenuator, 10 dB	34.85	33.26	30.89
870-SC-MF-S-15	SC Single-Mode Male to Female Attenuator, 15 dB	34.85	33.26	30.89
870-SC-MF-S-20	SC Single-Mode Male to Female Attenuator, 20 dB	34.85	33.26	30.89
870-SC-MF-S-25	SC Single-Mode Male to Female Attenuator, 25 dB	34.85	33.26	30.89

FIBER FC SINGLE-MODE PLUG TYPE ATTENUATORS

- Stable and accurate attenuation value.
- Low back reflection.
- Single-mode type.
- Bi-directional, Non air gap.
- Zirconia ferrule and split sleeve.
- Dust caps included.
- Bellcore Standard GR-326-CORE compliant.
- Other attenuator values are available upon request.



ORDER CODE	DESCRIPTION	1-24	25-49	50+
870-FC-MF-S-05	FC Single-Mode Male to Female Attenuator, 5 dB	\$34.85	33.26	30.89
870-FC-MF-S-10	FC Single-Mode Male to Female Attenuator, 10 dB	34.85	33.26	30.89
870-FC-MF-S-15	FC Single-Mode Male to Female Attenuator, 15 dB	34.85	33.26	30.89
870-FC-MF-S-20	FC Single-Mode Male to Female Attenuator, 20 dB	34.85	33.26	30.89
870-FC-MF-S-25	FC Single-Mode Male to Female Attenuator, 25 dB	34.85	33.26	30.89

FIBER LC SINGLE-MODE PLUG TYPE ATTENUATORS

- Stable and accurate attenuation value.
- Low back reflection.
- Single-mode type.
- Bi-directional, no air gap.
- Zirconia ferrule mounted with sleeve.
- Dust cap included.
- Bellcore Standard GR-910-CORE Compliant.
- Other attenuator values are available upon request.



ORDER CODE	DESCRIPTION	1-24	25-29	50+
870-LC-MF-S-05	LC Single-Mode Male to Female Attenuator, 5 dB	\$52.45	50.06	46.49
870-LC-MF-S-10	LC Single-Mode Male to Female Attenuator, 10 dB	52.45	50.06	46.49
870-LC-MF-S-15	LC Single-Mode Male to Female Attenuator, 15 dB	52.45	50.06	46.49
870-LC-MF-S-20	LC Single-Mode Male to Female Attenuator, 20 dB	52.45	50.06	46.49

10G MULTIMODE FIBER OPTIC BULK CABLE

FIBER REEL BULK CABLE

- Duplex zip cord or "8 Shape" in LSZH
- 10 Gigabit Multimode
- 1000 feet/reel
- ZIP : OD 2.8*5.7mm
- MiniZip : OD 1.8*4.1mm
- Color: Aqua

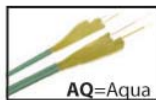

ORDER CODE	DESCRIPTION	1-4	5-9	10+
820-ZIP-OM3-AQ	ZIP 10G Multimode, 1000 ft	\$450.00	425.00	395.00
820-MZIP-OM3-AQ	MINIZIP 10G Multimode, 1000 ft	450.00	425.00	395.00

SINGLEMODE FIBER OPTIC BULK CABLE

FIBER REEL BULK CABLE

- Duplex zip cord or "8 Shape" in PVC
- Single Mode
- 1000 feet/reel
- ZIP : OD 2.8*5.7mm
- MiniZip : OD 1.8*4.1mm
- Color: Yellow



ORDER CODE	DESCRIPTION	1-4	5-9	10+
820-ZIP-SM-YL	ZIP Single mode, 1000 ft	\$250.00	230.00	210.00
820-MZIP-SM-YL	MINIZIP Single mode, 1000 ft	250.00	230.00	210.00

FIBER CHECKER PRO

- Universally Connector for testing different ST, SC, FC, and FDDI interfaces.
- Test for both single-mode and multi-mode cables.
- Wavelength: 650 nm.
- Range visibility: Up to 3 km.
- Power Source: 2 AAA batteries.
- LED indicator for Power, Battery Low, and CW/Pulse.
- Highly effective power circuits allow for stable laser power.
- Locate any possible breaks or unseen faults in the cable by sending a red laser light down the fiber.



ORDER CODE	1-9	10-19	20+
069-FC-2005	\$184.80	176.40	163.80

FIBER MULTIMEDIA

FIBER OPTIC - COMPACT MULTIMEDIA SNAP-IN MODULE

- Compact design fit into any keystone jack cutout (Size: 14.60mm Width x 16mm Height x D (length))
- Design for multimedia wall plate or feed-thru panel
- Available in multi color solution

YY = Color	WH	BK	RD	OR	IV
	GY	BL	GN	YL	

LC (Duplex) D=1.37"/34.80mm 071D-DLC-YY	SC D=1.31"/33.20mm 071D-ISC-YY	ST D=1.265"/32.00mm 071D-IST-YY	MTRJ D=1.33"/33.60mm 071D-MTRJ-YY

ORDER CODE	DESCRIPTION	1-49	50-99	100+
071D-DLC-YY	LC (Duplex)	\$5.98	5.71	5.30
071D-ISC-YY	SC	3.34	3.19	2.96
071D-IST-YY	ST	3.34	3.19	2.96
071D-MTRJ-YY	MTRJ	5.28	5.04	4.68

MULTI COLOR MULTIMODE FIBER OPTIC BULK CABLE

FIBER REEL BULK CABLE

- Duplex zip cord or "8 Shape" in PVC
- 50/125 Multimode or 62.5/125 Multimode
- 1000 feet/reel
- ZIP : OD 2.8*5.7mm
- MiniZip : OD 1.8*4.1mm



YY=Color	SWH-White	GY-Gray	PP-Purple	BR-Black	RD-Red	OR-Orange	BL-Blue	GN-Green	PK-Pink	YL-Yellow			
ORDER CODE	DESCRIPTION										1-4	5-9	10+
820-ZIP-MM-YY	ZIP 62.5/125 Multimode, 1000 ft										\$270.00	250.00	230.00
820-ZIP-5M-YY	ZIP 50/125 Multimode, 1000 ft										270.00	250.00	230.00
820-MZIP-MM-YY	MINIZIP 62.5/125 Multimode, 1000 ft										270.00	250.00	230.00
820-MZIP-5M-YY	MINIZIP 50/125 Multimode, 1000 ft										270.00	250.00	230.00

DISTRIBUTION TYPE 62.5/125u MULTIMODE FIBER

820-2C-MM-OR	820-4C-MM-OR	820-12C-MM-OR
820-6C-MM-OR	820-8C-MM-OR	

- Multimode 62.5/125u
- Indoor Type
- Tight buffered
- RoHS PVC Fiber Optic Cable
- Color: Orange

ORDER CODE	DESCRIPTION	PRICE PER FEET
820-2C-MM-OR	Fiber 2 Strand Multimode Bulk Cable	\$0.25
820-4C-MM-OR	Fiber 4 Strand Multimode Bulk Cable	0.49
820-6C-MM-OR	Fiber 6 Strand Multimode Bulk Cable	0.65
820-8C-MM-OR	Fiber 8 Strand Multimode Bulk Cable	1.08
820-12C-MM-OR	Fiber 12 Strand Multimode Bulk Cable	1.20

MODE CONDITIONING FIBER PATCH CABLE

DESCRIPTION

A Mode Conditioning Patchcord (MCP) is a duplex multimode cord that has a small length of single fiber at the start of the transmission length. The basic principle behind the cord is to launch laser into the small section of single mode fiber. The other end of the single mode fiber is coupled to the multimode section of the cable with the offset from the center of the multimode fiber.

FEATURE

- Compliant with IEEE802.3z
- Eliminates DMD phenomenon
- Low Insertion Loss (<0.5dB)
- Uses precision ceramic ferrules
- Rugged offset splicing closure
- Available in 62.5 or 50 um multimode fiber
- Easy to use as standard patch cords

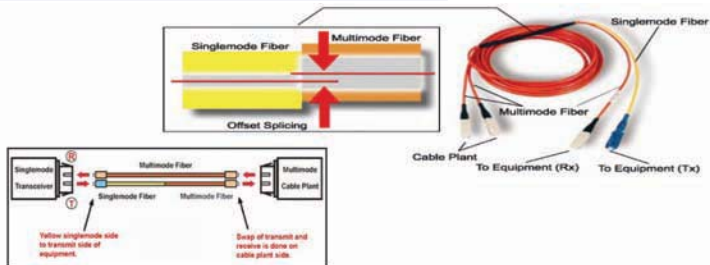

ORDER CODE	DESCRIPTION	1-49	50-99	100+
860-DSC-DLC-MODE-3M	Duplex SC to Duplex LC Mode Conditioning Patch Cord, 3 meter	\$61.25	58.46	54.29
860-DSC-DLC-MODE-5M	Duplex SC to Duplex LC Mode Conditioning Patch Cord, 5 meter	63.36	60.48	56.16
860-DST-DLC-MODE-3M	Duplex ST to Duplex LC Mode Conditioning Patch Cord, 3 meter	61.25	58.46	54.29
860-DST-DLC-MODE-5M	Duplex ST to Duplex LC Mode Conditioning Patch Cord, 5 meter	63.36	60.48	56.16

*Custom length and configuration are available upon request. Please call for price.

FEATURES AND BENEFITS

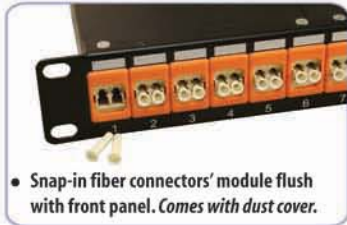

- Snap-in fiber connectors' module flush with front panel. Comes with dust cover.

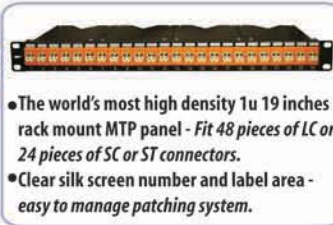

- The world's most high density 1u 19 inch rack mount MTP panel - Fit 48 pieces of LC or 24 pieces of SC or ST connectors.
- Clear silk screen number and label area - easy to manage patching system.

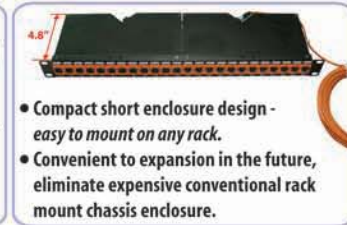

- Compact short enclosure design - easy to mount on any rack.
- Convenient to expansion in the future, eliminate expensive conventional rack mount chassis enclosure.

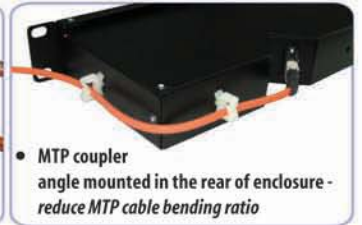

- MTP coupler angle mounted in the rear of enclosure - reduce MTP cable bending ratio

FIBER CONNECTORS



MTP/MPO

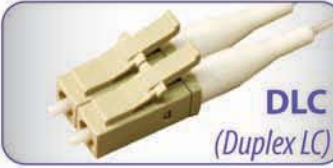

DLC (Duplex LC)



SC



ST

APPLICATION DIAGRAM

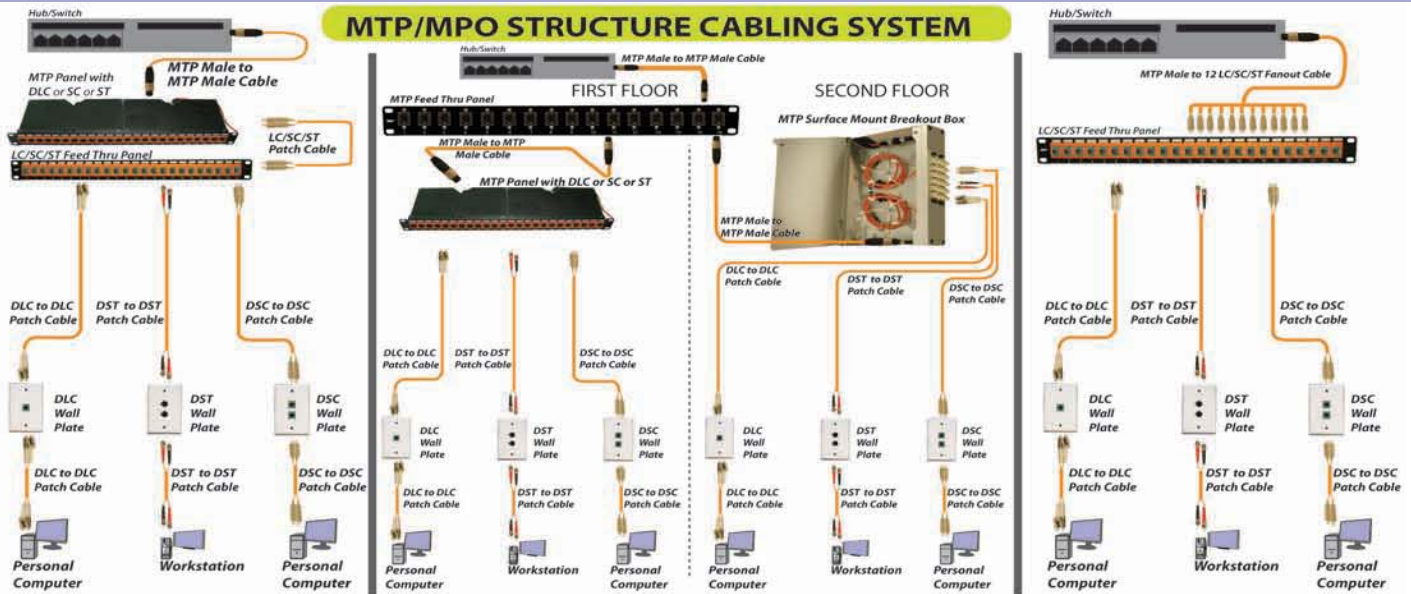

DUPLEX LC MTP / MPO BREAKOUT PANEL

62.5/125 Multimode 24 Ports	62.5/125 Multimode 12 Ports
50/125 Multimode 24 Ports	50/125 Multimode 12 Ports
10G Multimode 24 Ports	10G Multimode 12 Ports
Single Mode 24 Ports	Single Mode 12 Ports









PART NUMBER	DESCRIPTION	1-4	5-9	10+
898-DLC-24-M	24 Ports, 4 MTP Breakout Panel, 62.5/125 Multimode	\$845.52	\$807.09	\$749.44
898-DLC-12-M	12 Ports, 2 MTP Breakout Panel, 62.5/125 Multimode	\$437.15	\$417.28	\$387.47
PART NUMBER	DESCRIPTION	1-4	5-9	10+
898-DLC-24-5M	24 Ports, 4 MTP Breakout Panel, 50/125 Multimode	\$845.52	\$807.09	\$749.44
898-DLC-12-5M	12 Ports, 2 MTP Breakout Panel, 50/125 Multimode	\$437.15	\$417.28	\$387.47
PART NUMBER	DESCRIPTION	1-4	5-9	10+
898-DLC-24-10G	24 Ports, 4 MTP Breakout Panel, 10 G Multimode	\$855.62	\$816.73	\$758.39
898-DLC-12-10G	12 Ports, 2 MTP Breakout Panel, 10 G Multimode	\$442.20	\$422.10	\$391.95
PART NUMBER	DESCRIPTION	1-4	5-9	10+
898-DLC-24-S	24 Ports, 4 MTP Breakout Panel, Single Mode	\$1,069.46	\$1,020.85	\$947.93
898-DLC-12-S	12 Ports, 2 MTP Breakout Panel, Single Mode	\$549.12	\$524.16	\$486.72

DUPLEX SC MTP / MPO BREAKOUT PANEL

62.5/125 Multimode 12 Ports	62.5/125 Multimode 6 Ports
50/125 Multimode 12 Ports	50/125 Multimode 6 Ports
10G Multimode 12 Ports	10G Multimode 6 Ports
Single Mode 12 Ports	Single Mode 6 Ports

PART NUMBER	DESCRIPTION	1-4	5-9	10+
898-DSC-12-M	12 Ports, 2 MTP Breakout Panel, 62.5/125 Multimode	\$410.85	\$392.18	\$364.17
898-DSC-6-M	6 Ports, 1 MTP Breakout Panel, 62.5/125 Multimode	\$221.46	\$211.39	\$196.29
PART NUMBER	DESCRIPTION	1-4	5-9	10+
898-DSC-12-5M	12 Ports, 2 MTP Breakout Panel, 50/125 Multimode	\$410.85	\$392.18	\$364.17
898-DSC-6-5M	6 Ports, 1 MTP Breakout Panel, 50/125 Multimode	\$221.46	\$211.39	\$196.29
PART NUMBER	DESCRIPTION	1-4	5-9	10+
898-DSC-12-10G	12 Ports, 2 MTP Breakout Panel, 10 G Multimode	\$415.87	\$396.97	\$368.61
898-DSC-6-10G	6 Ports, 1 MTP Breakout Panel, 10 G Multimode	\$223.98	\$213.80	\$198.53
PART NUMBER	DESCRIPTION	1-4	5-9	10+
898-DSC-12-S	12 Ports, 2 MTP Breakout Panel, Single Mode	\$446.55	\$426.25	\$395.80
898-DSC-6-S	6 Ports, 1 MTP Breakout Panel, Single Mode	\$239.29	\$228.41	\$212.10





DUPLEX ST MTP/MPO BREAKOUT PANEL

62.5/125 Multimode 12 Ports	62.5/125 Multimode 6 Ports	PART NUMBER	DESCRIPTION	1-4	5-9	10+
		898-DST-12-M	12 Ports, 2 MTP Breakout Panel, 62.5/125 Multimode	\$410.85	\$392.18	\$364.17
		898-DST-6-M	6 Ports, 1 MTP Breakout Panel, 62.5/125 Multimode	\$221.46	\$211.39	\$196.29
50/125 Multimode 12 Ports	50/125 Multimode 6 Ports	PART NUMBER	DESCRIPTION	1-4	5-9	10+
		898-DST-12-5M	12 Ports, 2 MTP Breakout Panel, 50/125 Multimode	\$410.85	\$392.18	\$364.17
		898-DST-6-5M	6 Ports, 1 MTP Breakout Panel, 50/125 Multimode	\$221.46	\$211.39	\$196.29
10G Multimode 12 Ports	10G Multimode 6 Ports	PART NUMBER	DESCRIPTION	1-4	5-9	10+
		898-DST-12-10G	12 Ports, 2 MTP Breakout Panel, 10 G Multimode	\$415.87	\$396.97	\$368.61
		898-DST-6-10G	6 Ports, 1 MTP Breakout Panel, 10 G Multimode	\$223.98	\$213.80	\$198.53
Single Mode 12 Ports	Single Mode 6 Ports	PART NUMBER	DESCRIPTION	1-4	5-9	10+
		898-DST-12-S	12 Ports, 2 MTP Breakout Panel, Single Mode	\$446.55	\$426.25	\$395.80
		898-DST-6-S	6 Ports, 1 MTP Breakout Panel, Single Mode	\$239.29	\$228.41	\$212.10





MTP/MPO TO MTP/MPO CABLE

62.5/125 Multimode PVC		50/125 Multimode PVC		10G Multimode PVC		Single Mode PVC	
PART NUMBER	PRICE	PART NUMBER	PRICE	PART NUMBER	PRICE	PART NUMBER	PRICE
898-MTP-MTP-M-XX	\$76.00+\$4.50*meter	898-MTP-MTP-5M-XX	\$76.00+\$4.50*meter	898-MTP-MTP-10G-XX	\$76.00+\$8.00*meter	898-MTP-MTP-S-XX	\$108.00+\$3.00*meter
62.5/125 Multimode Plenum		50/125 Multimode Plenum		10G Multimode Plenum		Single Mode Plenum	
PART NUMBER	PRICE	PART NUMBER	PRICE	PART NUMBER	PRICE	PART NUMBER	PRICE
898P-MTP-MTP-M-XX	\$76.00+\$9.30*meter	898P-MTP-MTP-5M-XX	\$76.00+\$9.30*meter	898P-MTP-MTP-10G-XX	\$76.00+\$14.50*meter	898P-MTP-MTP-S-XX	\$108.00+\$5.50*meter





MTP/MPO TO 12 LC FANOUT CABLE

62.5/125 Multimode	50/125 Multimode	10G Multimode	Single Mode				
							
PART NUMBER	PRICE	PART NUMBER	PRICE	PART NUMBER	PRICE	PART NUMBER	PRICE
898-MTP-LC-M-XX	\$163.00+\$5.95*meter	898-MTP-LC-5M-XX	\$163.00+\$5.95*meter	898-MTP-LC-10G-XX	\$163.00+\$11.10*meter	898-MTP-LC-S-XX	\$177.00+\$3.95*meter

MTP/MPO TO 12 SC FANOUT CABLE

62.5/125 Multimode	50/125 Multimode	10G Multimode	Single Mode				
							
PART NUMBER	PRICE	PART NUMBER	PRICE	PART NUMBER	PRICE	PART NUMBER	PRICE
898-MTP-SC-M-XX	\$132.00+\$5.95*meter	898-MTP-SC-5M-XX	\$132.00+\$5.95*meter	898-MTP-SC-10G-XX	\$132.00+\$11.10*meter	898-MTP-SC-S-XX	\$139.00+\$3.95*meter

MTP/MPO TO 12 ST FANOUT CABLE

62.5/125 Multimode	50/125 Multimode	10G Multimode	Single Mode				
							
PART NUMBER	PRICE	PART NUMBER	PRICE	PART NUMBER	PRICE	PART NUMBER	PRICE
898-MTP-ST-M-XX	\$132.00+\$5.95*meter	898-MTP-ST-5M-XX	\$132.00+\$5.95*meter	898-MTP-ST-10G-XX	\$132.00+\$11.10*meter	898-MTP-ST-S-XX	\$139.00+\$3.95*meter

MTP/MPO SURFACE MOUNT BREAKOUT BOX

MTP/MPO to LC Breakout Box



897-12-DLC-M
Build-in 1 set of MTP to 12 LC Fanout Cables, 62.5/125 Multimode, 12 LC Ports



897-24-DLC-M
Build-in 2 sets of MTP to 12 LC Fanout Cables, 62.5/125 Multimode, 24 LC Ports

PART NUMBER	DESCRIPTION	1-4	5-9	10+
897-12-DLC-M	62.5/125 Multimode, 1 MTP, 12 ports	\$490.14	\$467.86	\$434.44
897-24-DLC-M	62.5/125 Multimode, 2 MTP, 24 ports	\$874.14	\$834.41	\$774.81
897-12-DLC-5M	50/125 Multimode, 1 MTP, 12 ports	\$490.14	\$467.86	\$434.44
897-24-DLC-5M	50/125 Multimode, 2 MTP, 24 ports	\$874.14	\$834.41	\$774.81
897-12-DLC-10G	10G Multimode, 1 MTP, 12 ports	\$499.63	\$476.92	\$442.85
897-24-DLC-10G	10G Multimode, 2 MTP, 24 ports	\$893.13	\$852.53	\$791.64
897-12-DLC-S	Single Mode, 1 MTP, 12 ports	\$559.47	\$534.04	\$495.89
897-24-DLC-S	Single Mode, 2 MTP, 24 ports	\$1,012.79	\$966.76	\$897.70

MTP/MPO to SC Breakout Box



897-12-SC-10G
Build-in 1 set of MTP to 12 SC Fanout Cables, 10G Multimode, 12 SC Ports



897-24-SC-10G
Build-in 2 sets of MTP to 12 SC Fanout Cables, 10G Multimode, 24 SC Ports

PART NUMBER	DESCRIPTION	1-4	5-9	10+
897-12-SC-M	62.5/125 Multimode, 1 MTP, 12 ports	\$431.87	\$412.24	\$382.79
897-24-SC-M	62.5/125 Multimode, 2 MTP, 24 ports	\$757.61	\$723.17	\$671.52
897-12-SC-5M	50/125 Multimode, 1 MTP, 12 ports	\$431.87	\$412.24	\$382.79
897-24-SC-5M	50/125 Multimode, 2 MTP, 24 ports	\$757.61	\$723.17	\$671.52
897-12-SC-10G	10G Multimode, 1 MTP, 12 ports	\$441.37	\$421.31	\$391.22
897-24-SC-10G	10G Multimode, 2 MTP, 24 ports	\$776.60	\$741.30	\$688.35
897-12-SC-S	Single Mode, 1 MTP, 12 ports	\$486.06	\$463.97	\$430.83
897-24-SC-S	Single Mode, 2 MTP, 24 ports	\$865.97	\$826.61	\$767.57

MTP/MPO to ST Breakout Box



897-12-ST-S
Build-in 1 set of MTP to 12 ST Fanout Cables, Single Mode, 12 ST Ports



897-24-ST-S
Build-in 2 sets of MTP to 12 ST Fanout Cables, Single Mode, 24 ST Ports

PART NUMBER	DESCRIPTION	1-4	5-9	10+
897-12-ST-M	62.5/125 Multimode, 1 MTP, 12 ports	\$431.87	\$412.24	\$382.79
897-24-ST-M	62.5/125 Multimode, 2 MTP, 24 ports	\$757.61	\$723.17	\$671.52
897-12-ST-5M	50/125 Multimode, 1 MTP, 12 ports	\$431.87	\$412.24	\$382.79
897-24-ST-5M	50/125 Multimode, 2 MTP, 24 ports	\$757.61	\$723.17	\$671.52
897-12-ST-10G	10G Multimode, 1 MTP, 12 ports	\$441.37	\$421.31	\$391.22
897-24-ST-10G	10G Multimode, 2 MTP, 24 ports	\$776.60	\$741.30	\$688.35
897-12-ST-S	Single Mode, 1 MTP, 12 ports	\$486.06	\$463.97	\$430.83
897-24-ST-S	Single Mode, 2 MTP, 24 ports	\$865.97	\$826.61	\$767.57

19 INCHES 1U FIBER DLC/SC/ST FEEDTHRU PANEL

Duplex LC Feed Thru Panel



896-DLC-24-M
19 inches 1u Fiber DLC Feed Thru Panel, 62.5/125 Multimode, 24 ports



896-DLC-12-M
19 inches 1u Fiber DLC Feed Thru Panel, 62.5/125 Multimode, 12 ports

PART NUMBER	DESCRIPTION	1-4	5-9	10+
896-DLC-12-M	62.5/125 Multimode, 12 ports	\$70.40	\$67.20	\$62.40
896-DLC-24-M	62.5/125 Multimode, 24 ports	\$114.40	\$109.20	\$101.40
896-DLC-12-5M	50/125 Multimode, 12 ports	\$70.40	\$67.20	\$62.40
896-DLC-24-5M	50/125 Multimode, 24 ports	\$114.40	\$109.20	\$101.40
896-DLC-12-10G	10G Multimode, 12 ports	\$70.40	\$67.20	\$62.40
896-DLC-24-10G	10G Multimode, 24 ports	\$114.40	\$109.20	\$101.40
896-DLC-12-S	Single Mode, 12 ports	\$110.88	\$105.84	\$98.28
896-DLC-24-S	Single Mode, 24 ports	\$183.04	\$174.72	\$162.24

Simplex SC Feed Thru Panel



896-SC-24-10G
19 inches 1u Fiber SC Feed Thru Panel, 10 G Multimode, 24 ports



896-SC-12-10G
19 inches 1u Fiber SC Feed Thru Panel, 10 G Multimode, 12 ports

PART NUMBER	DESCRIPTION	1-4	5-9	10+
896-SC-12-M	62.5/125 Multimode, 12 ports	\$59.72	\$57.00	\$52.93
896-SC-24-M	62.5/125 Multimode, 24 ports	\$100.20	\$95.64	\$88.81
896-SC-12-5M	50/125 Multimode, 12 ports	\$59.72	\$57.00	\$52.93
896-SC-24-5M	50/125 Multimode, 24 ports	\$100.20	\$95.64	\$88.81
896-SC-12-10G	10G Multimode, 12 ports	\$59.72	\$57.00	\$52.93
896-SC-24-10G	10G Multimode, 24 ports	\$100.20	\$95.64	\$88.81
896-SC-12-S	Single Mode, 12 ports	\$73.88	\$70.53	\$65.49
896-SC-24-S	Single Mode, 24 ports	\$120.44	\$114.96	\$106.75

Simplex ST Feed Thru Panel



896-ST-24-S
19 inches 1u Fiber ST Feed Thru Panel, Single Mode, 24 ports



896-ST-12-S
19 inches 1u Fiber ST Feed Thru Panel, Single Mode, 12 ports

PART NUMBER	DESCRIPTION	1-4	5-9	10+
896-ST-12-M	62.5/125 Multimode, 12 ports	\$59.72	\$57.00	\$52.93
896-ST-24-M	62.5/125 Multimode, 24 ports	\$100.20	\$95.64	\$88.81
896-ST-12-5M	50/125 Multimode, 12 ports	\$59.72	\$57.00	\$52.93
896-ST-24-5M	50/125 Multimode, 24 ports	\$100.20	\$95.64	\$88.81
896-ST-12-10G	10G Multimode, 12 ports	\$59.72	\$57.00	\$52.93
896-ST-24-10G	10G Multimode, 24 ports	\$100.20	\$95.64	\$88.81
896-ST-12-S	Single Mode, 12 ports	\$73.88	\$70.53	\$65.49
896-ST-24-S	Single Mode, 24 ports	\$120.44	\$114.96	\$106.75

19 INCHES 1U MTP/MPO FEEDTHRU PANEL



891-MTP-12 19 inches 1u MTP Feed Thru Panel, 12 ports



891-MTP-16 19 inches 1u MTP Feed Thru Panel, 16 ports

PART NUMBER	DESCRIPTION	1-4	5-9	10+
891-MTP-12	12 ports	\$200.38	\$191.27	\$177.61
891-MTP-16	16 ports	\$261.10	\$249.23	\$231.43
PART NUMBER	DESCRIPTION	1-49	50-99	100+
890-MTP	MTP Coupler	\$14.15	\$13.51	\$12.54



FEATURES:

- Compact design fit into any keystone jack cutout
- Design for multimedia wallplate or feed-thru panel
- Up to six modules can be snapped in a single gang decora faceplate
- Available in multi color solution
- 19 inches panel - 24 ports in 1u/1.75 inches height, 48 ports in 2u/3.5 inches height

YY = Color WH GY BK BL GN RD OR YL IV

HIGH DENSITY MULTIMEDIA BLANK PANEL

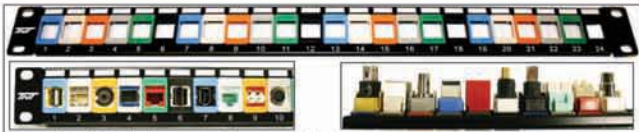





*Bezel and Modules are sold separately

PART NUMBER	DESCRIPTION	1-4	5-9	10+
015B-024B	24 ports, blank panel	\$15.75	\$15.04	\$13.96
015B-048B	48 ports, blank panel	\$21.12	\$20.16	\$18.72

AUDIO / VIDEO

HDMI	RCA	S-Video	F-Type	
 1.17" D=29.70mm 071D-HDMI-YY	 1.42" D=32.80mm 071D-RCA-YY	 1.44" D=36.50mm 071D-MDIN4-YY	 1.21" D=31.00mm 071D-IFF-S-YY	
BNC	3.5mm Audio	Banana Plugs	Speaker Terminal	
 1.27" D=32.20mm 071D-IBN-YY	 1.30" D=36.00mm 071D-35M-YY	 1.45" D=36.80mm 071D-BANA-YY	 1.64" D=41.62mm 071D-SP-YY	
PART NUMBER	DESCRIPTION	1-49	50-99	100+
071D-HDMI-YY	HDMI	\$4.40	\$4.20	\$3.90
071D-RCA-YY	RCA	\$2.20	\$2.10	\$1.95
071D-MDIN4-YY	S-Video	\$2.64	\$2.52	\$2.34
071D-IFF-S-YY	F-Type	\$1.41	\$1.34	\$1.25
071D-IBN-YY	BNC	\$2.20	\$2.10	\$1.95
071D-35M-YY	3.5mm Audio Jack	\$2.64	\$2.52	\$2.34
071D-BANA-YY	Banana Jack	\$3.08	\$2.94	\$2.73
071D-SP-YY	Speaker Terminal	\$2.20	\$2.10	\$1.95

FIBER OPTIC

LC (Duplex)	SC	ST	MTRJ	
 1.37" D=34.80mm 071D-DLC-YY	 1.31" D=33.20mm 071D-ISC-YY	 1.265" D=32.00mm 071D-IST-YY	 1.33" D=33.60mm 071D-MTRJ-YY	
PART NUMBER	DESCRIPTION	1-49	50-99	100+
071D-DLC-YY	LC (Duplex)	\$5.98	\$5.71	\$5.30
071D-ISC-YY	SC	\$3.34	\$3.19	\$2.96
071D-IST-YY	ST	\$3.34	\$3.19	\$2.96
071D-MTRJ-YY	MTRJ	\$5.28	\$5.04	\$4.68

USB & FIREWIRE

USB Type-A	USB Type-B	6-Pin Firewire	4-Pin Firewire	
 1.6" D=40.60mm 071D-USBA-YY	 1.62" D=41.00mm 071D-USBB-YY	 1.62" D=41.00mm 071D-FW-YY	 1.36" D=34.60mm 071D-FWM-YY	
PART NUMBER	DESCRIPTION	1-49	50-99	100+
071D-USBA-YY	USB-A/A	\$2.20	\$2.10	\$1.95
071D-USBB-YY	USB-B/B	\$2.20	\$2.10	\$1.95
071D-FW-YY	6 Pin Firewire	\$2.64	\$2.52	\$2.34
071D-FWM-YY	4-Pin Firewire	\$2.64	\$2.52	\$2.34

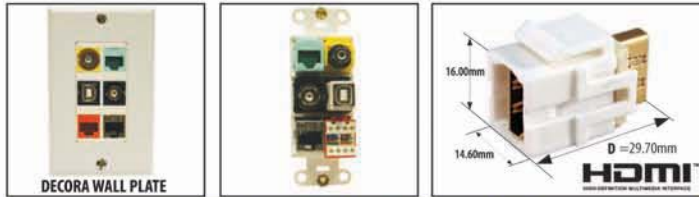

DECORA SINGLE GANG FACEPLATES

07X-101-ZZ	07X-102-ZZ	07X-103-ZZ	07X-104-ZZ	07X-106-ZZ	07X-F-1-ZZ
ZZ = color IV: Ivory, WH: White					
PART NUMBER	DESCRIPTION	1-49	50-99	100+	
07X-101-ZZ	1 Port	\$0.69	\$0.66	\$0.61	
07X-102-ZZ	2 Ports	\$0.69	\$0.66	\$0.61	
07X-103-ZZ	3 Ports	\$0.69	\$0.66	\$0.61	
07X-104-ZZ	4 Ports	\$0.86	\$0.82	\$0.76	
07X-106-ZZ	6 Ports	\$0.86	\$0.82	\$0.76	
07X-F-1-ZZ	Cover Plate	\$0.51	\$0.49	\$0.45	

VOICE & LAN

Cat6a Shielded Coupler	Cat6a Coupler	Cat6a Keystone Jack 90°	Cat6a Keystone Jack 180°	
 1.18" D=32.00mm 080-885-SI-C6A-SH	 1.21" D=30.80mm 080-885-SI-C6A	 1.30" D=31.20mm 07WF-188-M-C6A	 1.22" D=32.60mm 07WF-188-M-C6A	
Cat6 Shielded Coupler	Cat6 Coupler	Cat6 Keystone Jack 90°	Cat6 Keystone Jack 180°	
 1.18" D=30.00mm 080-885-C6-SI-SH	 1.16" D=29.30mm 080-885-SI-C6	 1.23" D=31.20mm 07WF-188-YY-M	 1.45" D=32.80mm 07WF-188-YY-M	
Cat5e Shielded Coupler	Cat5e Coupler	Cat5e Keystone Jack 90°	Cat5e Keystone Jack 180°	
 1.18" D=30.00mm 080-C5E-SI-SH-M	 1.16" D=29.40mm 080-885-C5-M	 1.21" D=30.70mm 07F-188-YY-M	 1.45" D=32.80mm 07F-188-YY-M	
RJ-12 Keystone Jack 90°	RJ-12 Snap-In Coupler	RJ-45 Snap-In Coupler		
 1.22" D=31.00mm 07F-166-YY-M	 1.06" D=26.96mm 080-665-SI	 1.06" D=26.96mm 080-885-SI		
PART NUMBER	DESCRIPTION	1-49	50-99	100+
080-885-SI-C6A-SH	Cat6a Shielded Coupler	\$9.24	\$8.82	\$8.19
080-885-SI-C6A	Cat6a Coupler	\$6.51	\$6.22	\$5.77
07WF-188-M-C6A	Cat6a Keystone Jack 90°	\$6.16	\$5.88	\$5.46
07WF-188-M-C6A	Cat6a Keystone Jack 180°	\$6.51	\$6.22	\$5.77
080-885-C6-SI-SH	Cat6 Shielded Coupler	\$6.95	\$6.64	\$6.16
080-885-SI-C6	Cat6 Coupler	\$5.90	\$5.63	\$5.23
07WF-188-YY-M	Cat6 Keystone Jack 90°	\$5.63	\$5.38	\$4.99
07WF-188-YY-M	Cat6 Keystone Jack 180°	\$5.98	\$5.71	\$5.30
080-C5E-SI-SH-M	Cat5e Shielded Coupler	\$4.75	\$4.54	\$4.21
080-885-C5-M	Cat5e Coupler	\$3.87	\$3.70	\$3.43
07F-188-YY-M	Cat5e Keystone Jack 90°	\$2.46	\$2.35	\$2.18
07F-188-YY-M	Cat5e Keystone Jack 180°	\$2.64	\$2.52	\$2.34
07F-166-YY-M	RJ-12 Keystone Jack 90°	\$1.94	\$1.85	\$1.72
080-665-SI	RJ-12 Snap-In Coupler	\$1.76	\$1.68	\$1.56
080-885-SI	RJ-45 Snap-In Coupler	\$1.67	\$1.60	\$1.46

ACCESSORIES

Mini Snap-in Bezel	Blank Insert Module			
 073B-ALL-YY	 0.74" D=18.80mm 071D-IS-XX			
XX = color IV: Ivory, WH: White, BK: Black				
PART NUMBER	DESCRIPTION	1-49	50-99	100+
073B-ALL-YY	Mini Snap-in Bezel	\$0.18	\$0.17	\$0.16
071D-IS-XX	Blank Insert Module	\$0.28	\$0.27	\$0.25

CAT6a PATCH PANELS

110 PATCH PANEL

- Exceeds TIA/EIA CAT6 specification to support 10G Base-T and Gigabyte Ethernet system application.
- Hardware certification comply with TIA/EIA-568-B.2-1 CAT6.
- 110 IDC accepts 23-24 AWG wires.
- Available in both T568A and T568B universal wiring.
- Product is RoHS Compliant.



ORDER CODE	DESCRIPTION	HEIGHT	1-4	5-9	10+
01W-24-C6A	Cat6a Patch Panel, 24 Port, 568A/B	1 3/4"	149.60	142.80	132.60
01W-48-C6A	Cat6a Patch Panel, 48 Port, 568A/B	3 1/2"	290.40	277.20	257.40

FEED-THRU PANEL

- Category 6a in-line coupler snapped on to the panel.
- 19" wide black color, 1/8" thick steel panel.
- Clear white silk screen numbers on the panel.
- Black color bezels hold the couplers flush with front panel.



ORDER CODE	DESCRIPTION	HEIGHT	1-4	5-9	10+
01G-08-C6A	Cat6a Feed Through Panel, 08 port	1 3/4"	\$103.84	99.12	92.04
01G-12-C6A	Cat6a Feed Through Panel, 12 port	1 3/4"	137.28	131.04	121.68
01G-16-C6A	Cat6a Feed Through Panel, 16 port	1 3/4"	170.72	162.96	151.32
01G-24-C6A	Cat6a Feed Through Panel, 24 port	3 1/2"	239.36	228.48	212.16
01G-32-C6A	Cat6a Feed Through Panel, 32 port	3 1/2"	306.24	292.32	271.44
01G-48-C6A	Cat6a Feed Through Panel, 48 port	5 1/4"	440.00	420.00	390.00

HIGH DENSITY FEED-THRU PANEL

- 19" wide black color, 1/8" thick steel panel.
- Clear white silk screen number on the panel.
- Cat6a mini couplers loaded.



ORDER CODE	DESCRIPTION	1-4	5-9	10+
016-016-C6A	1U 16-Port - Cat6a Couplers Loaded	\$147.84	141.12	131.04
016-024-C6A	1U 24-Port - Cat6a Couplers Loaded	225.28	215.04	199.68
016-048-C6A	2U 48-Port - Cat6a Couplers Loaded	425.92	406.56	377.52

*** ALL CAT6a PRODUCTS ARE RoHS COMPLIANT. ***

CAT6a KEYSTONE JACK

CAT6a 90° 110 TYPE MINI KEYSTONE JACK SHIELDED



- Exceeds TIA/EIA CAT6 specification to support 10G Base-T and Gigabyte Ethernet system application
- Hardware certification comply with TIA/EIA-568-B.2-1 CAT6
- Mountable for all kinds of standard keystone jack opening
- Wire pins are plated with 50 micro inches gold over nickle
- 110 IDC accepts 23-24 AWG wires
- Available in both T568A and T568B universal wiring
- Product is RoHS Compliant
- Shielded

ORDER CODE	DESCRIPTION	1-49	50-99	100+
07E-I88-M-C6A	Cat6a 90° 110 Type Mini Keystone Jack Shielded	\$11.00	10.50	9.75

CAT6a 180° 110 TYPE MINI KEYSTONE JACK



- Exceeds TIA/EIA CAT6 specification to support 10G Base-T and Gigabyte Ethernet system application
- Hardware certification comply with TIA/EIA-568-B.2-1 CAT6
- Mountable for all kinds of standard keystone jack opening
- Wire pins are plated with 50 micro inches gold over nickle
- 110 IDC accepts 23-24 AWG wires
- Available in both T568A and T568B universal wiring
- Product is RoHS Compliant

ORDER CODE	DESCRIPTION	1-49	50-99	100+
07W-I88-M-C6A	Cat6a 180° 110 Type Mini Keystone Jack	\$6.51	6.22	5.77

CAT6a 90° 110 TYPE MINI KEYSTONE JACK



- Exceeds TIA/EIA CAT6 specification to support 10G Base-T and Gigabyte Ethernet system application
- Hardware certification comply with TIA/EIA-568-B.2-1 CAT6
- Mountable for all kinds of standard keystone jack opening
- Wire pins are plated with 50 micro inches gold over nickle
- 110 IDC accepts 23-24 AWG wires
- Available in both T568A and T568B universal wiring
- Product is RoHS Compliant

ORDER CODE	DESCRIPTION	1-49	50-99	100+
07WF-I88-M-C6A	Cat6a 90° 110 Type Mini Keystone Jack	\$6.16	5.88	5.46

CAT6a COUPLERS

CAT6a SHIELDED SNAP-IN COUPLER PANEL MOUNTABLE



- Snap-in type enclosure allows easy mounting onto any keystone jack wall plate or panel.
- Shielded
- Compact Size: 0.57" (W) x 0.64" (H) x 1.18" (D)

ORDER CODE	1-49	50-99	100+
080-885-SI-C6A-SH	\$9.24	8.82	8.19

CAT6a UNSHIELDED SNAP-IN COUPLER PANEL MOUNTABLE



- Snap-in type enclosure allows easy mounting onto any keystone jack wall plate or panel.
- Unshielded
- Color: Black
- Compact Size: 0.57" (W) x 0.64" (H) x 1.21" (D)

ORDER CODE	1-49	50-99	100+
080-885-SI-C6A-BK	\$6.51	6.22	5.77

CAT6a UNSHIELDED IN-LINE COUPLER



- Compliant with EIA/TIA Cat6 Channel Performance specification
- Patented PCB (Printed Circuit Board) design for optimal performance
- Unshielded
- Color: White
- Compact Size: 0.57" (W) x 0.64" (H) x 1.17" (D)

ORDER CODE	1-49	50-99	100+
080-RJ45-C6A	\$6.25	5.96	5.54

CAT6a 30 AWG BULK CABLE SHIELDED

CAT6a PATCH CABLE - 30 AWG STRANDED SHIELDED

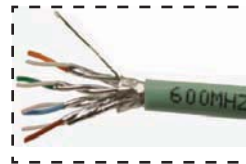

- 30 AWG, Stranded, Shielded, Category 6a cable
- Aqua Color
- 1000 feet per box

ORDER CODE	1-4	5-9	10+
06GA-R4P-T30-AQ-SH	\$380.00	350.00	320.00

CAT6a RJ45 SHIELDED PLUG



- Cat6a RJ 45 Shielded Plug
- Exceeds EIA/TIA Category 6 specification
- 3-Pieces type
- Work with 30 AWG, Stranded, Shielded, Cat6a cables

ORDER CODE	1-499	500-999	1000+
060-R88-T50-C6A-SH	\$1.41	1.34	1.25

CAT6a 24 AWG BULK CABLE UNSHIELDED

CAT6a 24 AWG STRANDED UNSHIELDED CABLE

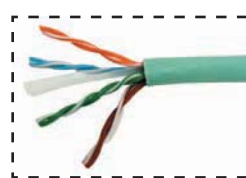

- 24 AWG, Stranded, Unshielded, Category 6a Cable
- 4 pair UTP Cable
- Aqua Color
- 1000 feet per box

ORDER CODE	1-4	5-9	10+
06GA-R4P-T24-AQ	\$285.00	270.00	250.00

CAT6a RJ45 PLUG FOR 24 AWG STRANDED, UNSHIELDED CABLE



- Cat6a RJ 45 Stranded, Unshielded Plug
- Exceeds EIA/TIA Category 6 specification
- 3-Pieces type
- Staggered conductors guide
- Works with stranded, unshielded Cat6a cables.

ORDER CODE	1-499	500-999	1000+
060-R88-T50-C6E	\$0.70	0.67	0.62

CABLE:

- 24 AWG, stranded bare copper, four twisted pair PVC cable, ETL/UL verified, meets and exceeds Category 6 specifications.
- Exceeds Category 6 - long body 3 pieces stagger type RJ-45 plug with snag-free strain relief boots.
- Color: Aqua.



QUALITY TESTING:

- 100% FLUKE tested and certified.
- 100% continuity with AQL 15% Attenuation, NEXT, Return Loss, Impedance testing.
- New CAT6 RJ-45 plug improves NEXT performances.
- Meets and exceeds ANSI/TIA/EIA-568-B.2 Category 6 patch cable standards.



ASSEMBLY TYPE BOOT

- Snag-free strain relief boot provides the most secure and accurate connection.

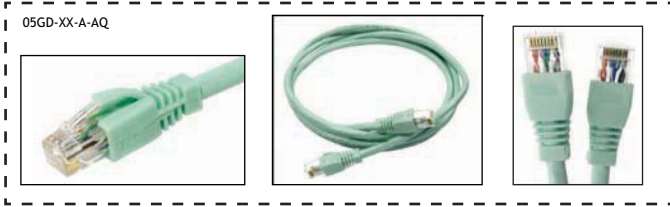

ORDER CODE	DESCRIPTION	1-49	50-99	100+
05GD-01-A-AQ	Cat6a Assembly Boot Type Patch Cord, 1 ft	\$5.80	5.64	5.24
05GD-02-A-AQ	Cat6a Assembly Boot Type Patch Cord, 2 ft	6.10	5.91	5.49
05GD-03-A-AQ	Cat6a Assembly Boot Type Patch Cord, 3 ft	6.40	6.18	5.74
05GD-05-A-AQ	Cat6a Assembly Boot Type Patch Cord, 5 ft	7.00	6.72	6.24
05GD-07-A-AQ	Cat6a Assembly Boot Type Patch Cord, 7 ft	7.60	7.26	6.74
05GD-10-A-AQ	Cat6a Assembly Boot Type Patch Cord, 10 ft	8.50	8.06	7.49
05GD-14-A-AQ	Cat6a Assembly Boot Type Patch Cord, 14 ft	10.00	9.41	8.74
05GD-20-A-AQ	Cat6a Assembly Boot Type Patch Cord, 20 ft	11.50	10.75	9.98
05GD-25-A-AQ	Cat6a Assembly Boot Type Patch Cord, 25 ft	13.00	12.10	11.23
05GD-50-A-AQ	Cat6a Assembly Boot Type Patch Cord, 50 ft	20.50	18.82	17.47
05GD-75-A-AQ	Cat6a Assembly Boot Type Patch Cord, 75 ft	28.00	25.54	23.71
05GD-100-A-AQ	Cat6a Assembly Boot Type Patch Cord, 100 ft	35.50	32.26	29.95

CUSTOM LENGTH PRICE

05GD-XX-A-AQ Cat6a Assembly Boot Type Patch Cord, Aqua \$5.50 + \$0.30/ft

XX = Cable Length



MOLDED TYPE BOOT

- Soft molded boot provides the most secure and accurate connection



ORDER CODE	DESCRIPTION	1-49	50-99	100+
05GDR-01-A-AQ	Cat6a Molded Type Patch Cord, 1 ft	\$5.80	5.64	5.24
05GDR-02-A-AQ	Cat6a Molded Type Patch Cord, 2 ft	6.10	5.91	5.49
05GDR-03-A-AQ	Cat6a Molded Type Patch Cord, 3 ft	6.40	6.18	5.74
05GDR-05-A-AQ	Cat6a Molded Type Patch Cord, 5 ft	7.00	6.72	6.24
05GDR-07-A-AQ	Cat6a Molded Type Patch Cord, 7 ft	7.60	7.26	6.74
05GDR-10-A-AQ	Cat6a Molded Type Patch Cord, 10 ft	8.50	8.06	7.49
05GDR-14-A-AQ	Cat6a Molded Type Patch Cord, 14 ft	10.00	9.41	8.74
05GDR-20-A-AQ	Cat6a Molded Type Patch Cord, 20 ft	11.50	10.75	9.98
05GDR-25-A-AQ	Cat6a Molded Type Patch Cord, 25 ft	13.00	12.10	11.23
05GDR-50-A-AQ	Cat6a Molded Type Patch Cord, 50 ft	20.50	18.82	17.47
05GDR-75-A-AQ	Cat6a Molded Type Patch Cord, 75 ft	28.00	25.54	23.71
05GDR-100-A-AQ	Cat6a Molded Type Patch Cord, 100 ft	35.50	32.26	29.95

CUSTOM LENGTH PRICE

05GDR-XX-A-AQ Cat6a Molded Type Patch Cord, Aqua \$5.50 + \$0.30/ft

XX = Cable Length

CABLE:

- 30 AWG, stranded bare copper, 10G four twisted individual pair foil shielded and over all aluminum mylar foil shielded, drain wire, ETL/UL verified.
- Meets Category 6a specifications, tested to 600 MHz.
- Color: Aqua.

MODULAR PLUG:

- Category 6a shielded long body single lay, gold plated stagger type with soft assembly type boots.

QUALITY TESTING:

- 100% continuity and ground testing with AWL, 15% Attenuation, NEXT, Return Loss, Impedance testing
- Staggered type Cat6a RJ-45 plug improves NEXT performances.
- Enclose fluke 4300 Cat6 pass testing report
- RoHS compliant

ASSEMBLY TYPE BOOT

- Snag-free strain relief boot provides the most secure and accurate connection.



ORDER CODE	DESCRIPTION	1-49	50-99	100+
05GH-01-A-AQ-C6A	Cat6a STP Cable, Assembly Type Boot, 1 ft	\$7.43	7.09	6.58
05GH-02-A-AQ-C6A	Cat6a STP Cable, Assembly Type Boot, 2 ft	7.81	7.46	6.93
05GH-03-A-AQ-C6A	Cat6a STP Cable, Assembly Type Boot, 3 ft	8.20	7.83	7.27
05GH-05-A-AQ-C6A	Cat6a STP Cable, Assembly Type Boot, 5 ft	8.98	8.57	7.96
05GH-07-A-AQ-C6A	Cat6a STP Cable, Assembly Type Boot, 7 ft	9.75	9.31	8.64
05GH-10-A-AQ-C6A	Cat6a STP Cable, Assembly Type Boot, 10 ft	10.91	10.42	9.67
05GH-14-A-AQ-C6A	Cat6a STP Cable, Assembly Type Boot, 14 ft	12.85	12.26	11.39
05GH-20-A-AQ-C6A	Cat6a STP Cable, Assembly Type Boot, 20 ft	14.78	14.11	13.10
05GH-25-A-AQ-C6A	Cat6a STP Cable, Assembly Type Boot, 25 ft	16.72	15.96	14.82
05GH-50-A-AQ-C6A	Cat6a STP Cable, Assembly Type Boot, 50 ft	26.40	25.20	23.40
05GH-75-A-AQ-C6A	Cat6a STP Cable, Assembly Type Boot, 75 ft	36.08	34.44	31.98
05GH-100-A-AQ-C6A	Cat6a STP Cable, Assembly Type Boot, 100 ft	45.76	43.68	40.56

CUSTOM LENGTH PRICE

05GH-XX-A-AQ-C6A Cat6a STP Cable, Assembly Type Boot, Aqua \$7.10 + \$0.40/ft

XX = Cable Length

MOLDED TYPE BOOT

- Soft molded boot provides the most secure and accurate connection

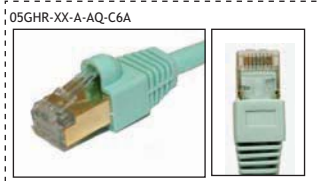

ORDER CODE	DESCRIPTION	1-49	50-99	100+
05GHR-01-A-AQ-C6A	Cat6a STP Cable, Molded Type Boot, 1 ft	\$7.43	7.09	6.58
05GHR-02-A-AQ-C6A	Cat6a STP Cable, Molded Type Boot, 2 ft	7.81	7.46	6.93
05GHR-03-A-AQ-C6A	Cat6a STP Cable, Molded Type Boot, 3 ft	8.20	7.83	7.27
05GHR-05-A-AQ-C6A	Cat6a STP Cable, Molded Type Boot, 5 ft	8.98	8.57	7.96
05GHR-07-A-AQ-C6A	Cat6a STP Cable, Molded Type Boot, 7 ft	9.75	9.31	8.64
05GHR-10-A-AQ-C6A	Cat6a STP Cable, Molded Type Boot, 10 ft	10.91	10.42	9.67
05GHR-14-A-AQ-C6A	Cat6a STP Cable, Molded Type Boot, 14 ft	12.85	12.26	11.39
05GHR-20-A-AQ-C6A	Cat6a STP Cable, Molded Type Boot, 20 ft	14.78	14.11	13.10
05GHR-25-A-AQ-C6A	Cat6a STP Cable, Molded Type Boot, 25 ft	16.72	15.96	14.82
05GHR-50-A-AQ-C6A	Cat6a STP Cable, Molded Type Boot, 50 ft	26.40	25.20	23.40
05GHR-75-A-AQ-C6A	Cat6a STP Cable, Molded Type Boot, 75 ft	36.08	34.44	31.98
05GHR-100-A-AQ-C6A	Cat6a STP Cable, Molded Type Boot, 100 ft	45.76	43.68	40.56

CUSTOM LENGTH PRICE

05GHR-XX-A-AQ-C6A Cat6a STP Cable, Molded Type Boot, Aqua \$7.10 + \$0.40/ft

XX = Cable Length

CAT6 RJ45 110-TYPE PATCH PANELS



- Compliant with EIA/TIA Cat6 Channel Performance specifications.
- Patented PCB (Printed Circuit Board) design.
- 110 IDC type punch down termination.
- Universal for both 568A and 568B(258A) wiring schemes.
- Large port numbers and color-coded label for easy installation.
- Rack mountable (19" wide). Available in 12, 24, and 48 ports.

ORDER CODE	DESCRIPTION	HEIGHT	1-4	5-9	10+
01WR-12	Cat6 Patch Panel, 12 Port, 568A/B	1 3/4"	\$40.48	38.64	35.88
01WR-24	Cat6 Patch Panel, 24 Port, 568A/B	1 3/4"	52.80	50.40	46.80
01WR-48	Cat6 Patch Panel, 48 Port, 568A/B	3 1/2"	98.56	94.08	87.36

CAT6 SUPER HIGH DENSITY 110 PATCH PANEL



- Installation-friendly, upper and lower level ports are built separately in a strain relief tray
- User-friendly hand-screw for releasing/fastening the upper level, requiring no tools.
- Helps to lower the hardware cost by putting 48 ports in 1U panel.

ORDER CODE	1-4	5-9	10+
01WS-48	\$202.40	193.20	179.40

CAT6 SURFACE MOUNT PATCH PANELS



- Compliant with EIA/TIA Cat6 Channel Performance specification.
- UL certified Cat6 Channel performance components.
- Patented PCB (Printed Circuit Board) design.
- 89D bracket surface mountable design. Black anodized panel with removable designation labels, snap-in type clear plastic cover.
- 110 IDC type punch down termination.
- Large port numbers and color coded label for easy installation.
- Universal for both 568A and 568B(258A) wiring scheme.

ORDER CODE	1-4	5-9	10+
01WR-12-WM	\$36.96	35.28	32.76

CAT6 RJ45 FEED THROUGH PATCH PANELS



- Category 6 RJ45 in-line coupler snapped on to the panel.
- 19" wide black color, 1/8" thick steel panel.
- Clear white silk screen numbers on the panel.
- Black color bezels hold the couplers flush with front panel.

ORDER CODE	DESCRIPTION	HEIGHT	1-4	5-9	10+
01G-008-RJ45	Cat6 Feed Through Panel, 8 port	1 3/4"	\$98.56	94.08	87.36
01G-012-RJ45	Cat6 Feed Through Panel, 12 port	1 3/4"	130.24	124.32	115.44
01G-016-RJ45	Cat6 Feed Through Panel, 16 port	1 3/4"	161.92	154.56	143.52
01G-024-RJ45	Cat6 Feed Through Panel, 24 port	3 1/2"	255.28	215.04	199.68
01G-032-RJ45	Cat6 Feed Through Panel, 32 port	3 1/2"	288.64	275.52	255.84
01G-048-RJ45	Cat6 Feed Through Panel, 48 port	5 1/4"	415.36	396.48	368.16

1U (1 3/4") & 2U (3 1/2") HIGH DENSITY 16 / 24 / 48-PORT FEED-THRU PANEL

- 19" wide black color, 1/8" thick steel panel.
- Clear white silk screen number on the panel.
- Mini couplers can be loaded: RJ-12, RJ-45, Cat5E, Cat6.

ORDER CODE	DESCRIPTION	1-4	5-9	10+
016-016-B	1U 16-Port Blank Panel (Flush Type)	\$30.80	29.40	27.30
016-024-B	1U 24-Port Blank Panel (Flush Type)	35.20	33.60	31.20
016-048-B	2U 48-Port Blank Panel (Flush Type)	49.28	47.04	43.68
016-016-C6	1U 16-Port Panel - Cat6 Couplers Loaded	137.25	131.04	121.68
016-024-C6	1U 24-Port Panel - Cat6 Couplers Loaded	211.20	201.60	187.20
016-048-C6	2U 48-Port Panel - Cat6 Couplers Loaded	401.28	383.04	355.68

LUCENT 19" SHIELDED 16-PORT PANEL

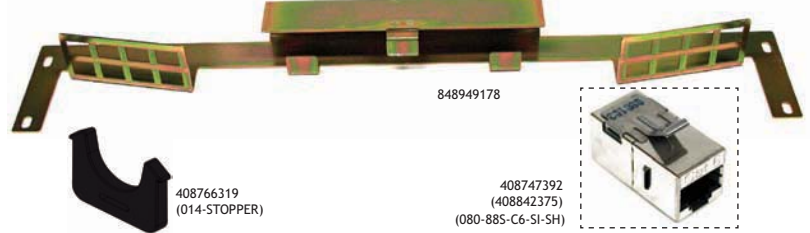

COMCODE	DESCRIPTION	1-49	50-99	100+
848949178	Lucent 19" Shielded 16-Port Panel	\$79.20	75.60	70.20
408766319	Stopper (014-STOPPER)	0.18	0.17	0.16
408747392/408842375	Cat6 Shielded Coupler (080-885-C6-SI-SH)	6.95	6.64	6.16

CAT6 KEYSTONE JACKS

90° & 180° KEYSTONE JACKS

- Compliant with EIA / TIA specifications.
- Dual color-coded labels for 568A and 568B wiring schemes.
- Uniquely patented PCB (Printed Circuit Board) design.
- Snap-in type enclosure allows easy mounting onto wall plates or panels.
- Compact style, fits into 016-024 / 016-048 panels.



ORDER CODE	DESCRIPTION	1-49	50-99	100+
07W-188-YY-M	Cat6 180° Mini Keystone Jack	\$5.98	5.71	5.30
07WF-188-YY-M	Cat6 90° Mini Keystone Jack	5.63	5.38	4.99

XX = Color	WH	BK	RD	OR	IV
	GY	BL	GN	YL	



CAT6 RJ45 TOOL-FREE KEYSTONE JACK

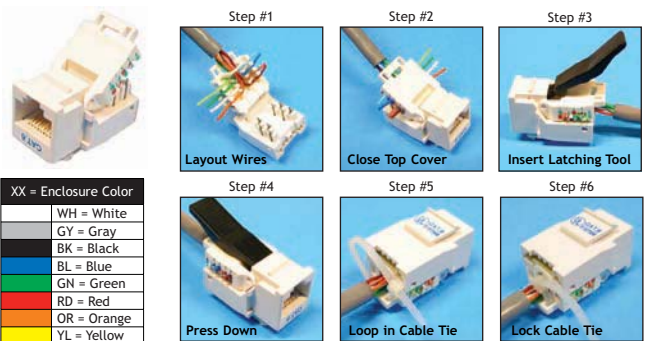

ORDER CODE	DESCRIPTION	1-49	50-99	100+
07WK-188-XX	CAT6 RJ45 Tool-Free Keystone Jack	\$5.28	5.04	4.68

IMPACT PUNCH DOWN TOOL AND REPLACEMENT BLADE

- Easy grip handle.
- Includes 110 or 66 insert and cut blade.
- Easy to use spring loaded design.
- Interchangeable blades.
- Storage compartment for additional blade.

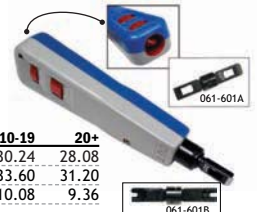

ORDER CODE	DESCRIPTION	1-9	10-19	20+
061-110P	Impact Tool with 110 Blade	\$31.68	30.24	28.08
061-66P	Impact Tool with 66 Blade	35.20	33.60	31.20
061-601A	Blade for 66 Terminal	10.56	10.08	9.36

** RoHS Compliant Available Upon Request**



- CAT6 RJ45 IN-LINE COUPLER**
- Compliant with EIA/TIA Cat6 Channel Performance specification.
 - Patented PCB (Printed Circuit Board) design for optimal performance.
 - Compact Size: 0.57" x 0.64" x 1.17".



- SHIELDED CAT6 RJ45 IN-LINE COUPLER-PANEL MOUNTABLE**
- Snap-In type enclosure allows easy mounting onto any Keystone Jack wall plates or panels.
 - Fully shielded enclosure meets EMI/RFI requirements.



- CAT6 RJ45 IN-LINE COUPLER PANEL MOUNTABLE**
- Snap-In type enclosure allows easy mounting onto any Keystone Jack wall plates or panels.

ORDER CODE	DESCRIPTION	1-49	50-99	100+
080-RJ45-C6	Cat6 RJ45 In-Line Coupler	\$5.72	5.46	5.07
080-885-SI-C6	Cat6 RJ45 Snap In Type Coupler	5.90	5.63	5.23
080-885-C6-SI-SH	Cat6 RJ45 Snap In Type Coupler, Shielded	6.95	6.64	6.16

** LUCENT NIE EXEMPTION TYPE **

CAT6 CROSS-OVER COUPLER

- RJ-45 Cat6 Cross-Over coupler - meets EIA/TIA 568A Category 6 specification.
- Compact enclosure printed w/wiring scheme - works in any Cat6 Cross-Over coupling environment.
- Patented PCB (Printed Circuit Board) design ensures Cat6 performance.
- Ideal for Hub to Hub cascade, or Station to Station connection of Gigabit Ethernet.
- Wiring Scheme: 1-3, 2-6, 3-1, 4-7, 5-8, 6-2, 7-4, 8-5.

ORDER CODE	1-49	50-99	100+
080-88-CR-C6	\$6.42	6.13	5.69

** LUCENT NIE EXEMPTION TYPE **



KEYSTONE JACK CRIMPING TOOLS

TERMINATION TOOL FOR CAT6 180° TOP-ENTRY MINI KEYSTONE JACK

- Termination and Wire-Cutting Tool for Top-Entry Keystone Jack Module
- Works with Cat6 180° Mini Keystone Jacks (P/N: 07W-188-YY-M)



ORDER CODE	1-9	10-19	20+
061-07W-RD	\$51.95	49.56	46.02

TERMINATION TOOL FOR CAT6 90° RIGHT-ANGLED MINI KEYSTONE JACK

- Termination and Wire-Cutting Tool for Right-Angled Keystone Jack Module
- Works with Cat6 90° Mini Keystone Jacks (P/N: 07WF-188-YY-M)

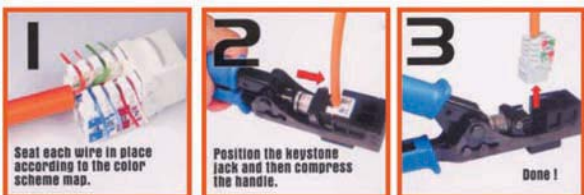

ORDER CODE	1-9	10-19	20+
061-07WF-YL	\$51.92	49.56	46.02

CAT6 110- PUNCH DOWN TYPE IN-LINE COUPLER

- Designed to extend or to fan out CAT6 4-pair cable without RJ45 connections.
- Wiring Scheme: pin to pin, 568A or 568B (258A) standard.
- Internal PCB (Printed Circuit Board) structure with plastic enclosure - meets EIA/TIA Cat6 specifications.
- Color-coded 110 punch down terminals.
- Surface mountable enclosure with cable tie loops.

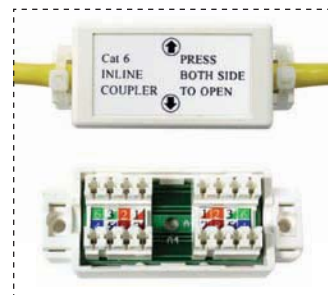

ORDER CODE	1-49	50-99	100+
080-110-4-C6	\$4.84	4.62	4.29



CAT6 110- PUNCH DOWN TYPE IN-LINE SHIELDED COUPLER

- For extension or fan out of shielded CAT6 4-pair cable without RJ-45 connections.
- Shielded enclosure with one dedicated terminal for drain wire punch down.
- Wiring Scheme: Pin to Pin, universal for both 568A or 568B(258A) standard.
- Internal PCB (Printed Circuit Board) structure with chrome plated enclosure - meets EIA/TIA Cat6 specifications.
- Surface mountable enclosure with cable tie loops.
- Color-coded 110 punch down terminals.

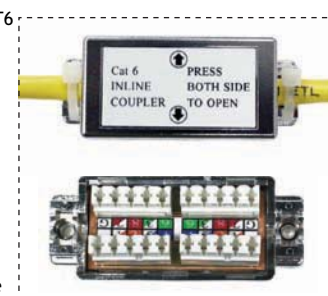

ORDER CODE	1-49	50-99	100+
080-110-4-C6-SH	\$7.39	7.06	6.55

CAT6 SURFACE JACKS



- Compliant with EIA/TIA Cat6 connecting hardware specifications.
- Patented PCB (Printed Circuit Board) design meets Cat6 performance.
- Universal for both 568A and 568B(258A) wiring schemes.

ORDER CODE	DESCRIPTION	1-49	50-99	100+
07Q-S-01-XX	Cat6 Surface Mount Jack, 1 x RJ45	\$6.34	6.05	5.62
07Q-S-02-XX	Cat6 Surface Mount Jack, 2 x RJ45	11.44	10.92	10.14
07Q-S-04-XX	Cat6 Surface Mount Jack, 4 x RJ45	21.12	20.16	18.72

XX = Enclosure Color WH IV

CAT6 PIGTAIL CABLE

CAT6 RJ-45 PLUG TO JACK - 6" PIGTAIL CABLE

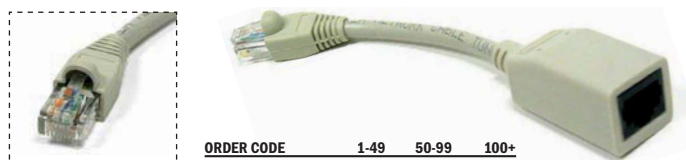

ORDER CODE	1-49	50-99	100+
086-C6-006	\$3.87	3.70	3.43

CAT6 CERTIFIED PATCH CABLES

CAT6 CERTIFIED RJ-45 UTP PATCH CABLES

- 24 AWG, stranded (7 x 32) bare copper, four twisted pair, ETL / UL verified, meets Category 6 specifications, tested to 550 MHz.
- Modular plug: Category 6 long body 3 pieces stagger type RJ-45 plug with snag-free strain relief boot.
- Snag-free strain relief boot provides the most secure and accurate connection.
- Multi-colored jackets enhance network cabling management solutions.
- FLUKE DSP-4300 100% tested and certified.



ORDER CODE	LENGTH	1-49	50-99	100+
05GD-01-A-XX	1 foot	\$5.54	5.29	4.91
05GD-02-A-XX	2 feet	5.81	5.54	5.15
05GD-03-A-XX	3 feet	6.07	5.80	5.38
05GD-05-A-XX	5 feet	6.60	6.30	5.85
05GD-07-A-XX	7 feet	7.13	6.80	6.32
05GD-10-A-XX	10 feet	7.92	7.56	7.02
05GD-15-A-XX	15 feet	9.24	8.82	8.19
05GD-20-A-XX	20 feet	10.56	10.08	9.36
05GD-25-A-XX	25 feet	11.88	11.34	10.53
05GD-50-A-XX	50 feet	18.48	17.64	16.38
05GD-75-A-XX	75 feet	25.08	23.94	22.23
05GD-100-A-XX	100 feet	31.68	30.24	28.08

XX = Jacket Color

WH	White
GY	Gray
BK	Black
BL	Blue
PP	Purple
GN	Green
RD	Red
OR	Orange
YL	Yellow
PK	Pink

• Custom Length: \$5.50 + \$0.28/feet



CAT6 CERTIFIED RJ-45 SHIELDED PATCH CABLES

- 26 AWG, stranded (7 x 32) bare copper, four twisted pair with aluminum mylar foil shielded, drain wire, ETL / UL verified, meets Category 6 specifications, tested to 550 MHz.
- Modular plug: Category 6 shielded long body 3 pieces stagger type RJ-45 plug with snag-free strain relief boot.
- Snag-free strain relief boot provides the most secure and accurate connection.
- Multi-colored jackets enhance network cabling management solutions.
- Meets and exceeds EIA/TIA 568A-4 Category 6 patch cable standards.
- FLUKE DSP-4300 100% tested and certified (4-25 feet only).

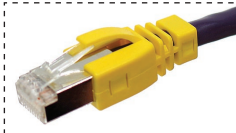

XX = Boot Color

WH	White
GY	Gray
BK	Black
BL	Blue
PP	Purple
GN	Green
RD	Red
OR	Orange
YL	Yellow
PK	Pink

ORDER CODE	LENGTH	1-49	50-99	100+
05GH-01-A-YY/XX	1 foot	\$6.86	6.55	6.08
05GH-02-A-YY/XX	2 feet	7.22	6.89	6.40
05GH-03-A-YY/XX	3 feet	7.57	7.22	6.71
05GH-05-A-YY/XX	5 feet	8.27	7.90	7.33
05GH-07-A-YY/XX	7 feet	8.98	8.57	7.96
05GH-10-A-YY/XX	10 feet	10.03	9.58	8.89
05GH-15-A-YY/XX	15 feet	11.79	11.26	10.45
05GH-20-A-YY/XX	20 feet	13.55	12.94	12.01
05GH-25-A-YY/XX	25 feet	15.31	14.62	13.57
05GH-50-A-YY/XX	50 feet	24.11	23.02	21.37
05GH-75-A-YY/XX	75 feet	32.91	31.42	29.17
05GH-100-A-YY/XX	100 feet	41.71	39.82	36.97

• Custom Length: \$6.60 + \$0.36/feet

MEDIA TWIST PATCH CABLES

- A UTP cabling for multimedia applications. Tested and certified on multiple systems above 100 MHz.
- The only UTP cable manufactured intentionally to achieve both conductor-to-conductor and pair-to-pair stability.
- 4-pair cable with extremely uniform dimensions and internal physical spacing.
- Delivers stable performance to 550 MHz, with electrical characteristics exceeding TIA/EIA Cat5e standards; ideal for Gigabit Ethernet, ATM, and Video channel applications.
- Unique crescent shape design - each pair is "locked" into place - ensures that pair-to-pair movement is greatly minimized during installation process.
- Short-body molded RJ-45 staggered plug with molded snag-free cap.
- All cables are AT&T 258A (568B) wiring. 568A wiring or other lengths are available upon request.

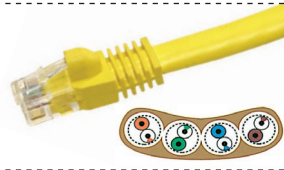

YY = Cable Color

WH	White
GY	Gray
BK	Black
BL	Blue
GN	Green
RD	Red
OR	Orange
YL	Yellow

ORDER CODE	LENGTH	1-49	50-99	100+
05W-01-A-XX	1 foot	\$4.36	4.17	3.87
05W-02-A-XX	2 feet	4.86	4.64	4.31
05W-03-A-XX	3 feet	5.35	5.11	4.74
05W-05-A-XX	5 feet	6.34	6.05	5.62
05W-07-A-XX	7 feet	7.32	6.99	6.49
05W-10-A-XX	10 feet	8.80	8.40	7.80
05W-15-A-XX	15 feet	11.26	10.75	9.98
05W-20-A-XX	20 feet	13.73	13.10	12.17
05W-25-A-XX	25 feet	16.19	15.46	14.35
05W-50-A-XX	50 feet	28.51	27.22	25.27
05W-75-A-XX	75 feet	40.83	38.98	36.19
05W-100-A-XX	100 feet	53.15	50.74	47.11

• Custom Length: \$4.00 + \$0.50/feet

CAT6 MOLDED PATCH CABLES

CAT6 MOLDED RJ-45 CABLE WITH SNAG FREE BOOT

- Molded strain relief with snag free cap from the cable entry to the end of plug.
- Cable: ETL/UL verified Cat6, 24 AWG, stranded (7 x 24) bare copper, 4 twisted pairs.



ORDER CODE	LENGTH	1-49	50-99	100+
05GR-01-A-XX	1 foot	\$3.78	3.61	3.35
05GR-02-A-XX	2 feet	4.05	3.86	3.59
05GR-03-A-XX	3 feet	4.31	4.12	3.82
05GR-05-A-XX	5 feet	4.84	4.62	4.29
05GR-07-A-XX	7 feet	5.37	5.12	4.76
05GR-10-A-XX	10 feet	6.16	5.88	5.46
05GR-15-A-XX	15 feet	7.48	7.14	6.63
05GR-20-A-XX	20 feet	8.80	8.40	7.80
05GR-25-A-XX	25 feet	10.12	9.66	8.97
05GR-50-A-XX	50 feet	16.72	15.96	14.82
05GR-75-A-XX	75 feet	23.32	22.26	20.67
05GR-100-A-XX	100 feet	29.92	28.56	26.52

• Custom Length: \$3.60 + \$0.28/feet

XX = Jacket Color

WH	BK	PP	RD	OR
GY	BL	GN	PK	YL

CAT6 MOLDED RJ-45 CABLE

- Molded strain relief boot from the cable entry to the end of plug.
- Cable: ETL/UL verified Cat6, 24 AWG, stranded (7x24) bare copper, 4 twisted pairs.

ORDER CODE	LENGTH	1-49	50-99	100+
05GE-01-A-XX	1 foot	\$3.78	3.61	3.35
05GE-02-A-XX	2 feet	4.05	3.86	3.59
05GE-03-A-XX	3 feet	4.31	4.12	3.82
05GE-05-A-XX	5 feet	4.84	4.62	4.29
05GE-07-A-XX	7 feet	5.37	5.12	4.76
05GE-10-A-XX	10 feet	6.16	5.88	5.46
05GE-15-A-XX	15 feet	7.48	7.14	6.63
05GE-20-A-XX	20 feet	8.80	8.40	7.80
05GE-25-A-XX	25 feet	10.12	9.66	8.97
05GE-50-A-XX	50 feet	16.72	15.96	14.82
05GE-75-A-XX	75 feet	23.32	22.26	20.67
05GE-100-A-XX	100 feet	29.92	28.56	26.52

• Custom Length: \$3.60 + \$0.28/feet

XX = Jacket Color

WH	BK	PP	RD	OR
GY	BL	GN	PK	YL

BELDEN CAT6 PATCH CABLES

- Cable: Belden 7883A, DataTwist 6, 24AWG, round solid-patch cable.

(A) Molded strain relief boot from the cable entry to the end of plug.

ORDER CODE	LENGTH	1-49	50-99	100+
05WE-01-A-XX	1 foot	\$3.92	3.75	3.48
05WE-02-A-XX	2 feet	4.33	4.13	3.84
05WE-03-A-XX	3 feet	4.73	4.52	4.20
05WE-05-A-XX	5 feet	5.54	5.29	4.91
05WE-07-A-XX	7 feet	6.35	6.06	5.63
05WE-10-A-XX	10 feet	7.57	7.22	6.71
05WE-15-A-XX	15 feet	9.59	9.16	8.50
05WE-20-A-XX	20 feet	11.62	11.09	10.30
05WE-25-A-XX	25 feet	13.64	13.02	12.09
05WE-50-A-XX	50 feet	23.76	22.68	21.06
05WE-75-A-XX	75 feet	33.88	32.34	30.03
05WE-100-A-XX	100 feet	44.00	42.00	39.00

• Custom Length: \$3.60 + \$0.42/feet

XX = Jacket Color

WH	BK	PP	RD	OR
GY	BL	GN	IV	YL



(B) Molded snagless strain relief boot from the cable entry to the end of plug.

ORDER CODE	LENGTH	1-49	50-99	100+
05GW-01-A-XX	1 foot	\$3.92	3.75	3.48
05GW-02-A-XX	2 feet	4.33	4.13	3.84
05GW-03-A-XX	3 feet	4.73	4.52	4.20
05GW-05-A-XX	5 feet	5.54	5.29	4.91
05GW-07-A-XX	7 feet	6.35	6.06	5.63
05GW-10-A-XX	10 feet	7.57	7.22	6.71
05GW-15-A-XX	15 feet	9.60	9.16	8.51
05GW-20-A-XX	20 feet	11.62	11.09	10.30
05GW-25-A-XX	25 feet	13.64	13.02	12.09
05GW-50-A-XX	50 feet	23.76	22.68	21.06
05GW-75-A-XX	75 feet	33.88	32.34	30.03
05GW-100-A-XX	100 feet	44.00	42.00	39.00

• Custom Length: \$3.60 + \$0.42/feet

XX = Jacket Color

WH	BK	PP	RD	OR
GY	BL	GN	IV	YL

ALL CAT6 PATCH CORDS ARE RoHS COMPLIANT

CAT6 BULK CABLES

- Category 6 Stranded cable: 4 pair UTP cable, 24 AWG, stranded for patch cables, 1000 feet per box.



ORDER CODE	DESCRIPTION	PRICE / 1000 FT
06G-R4P-T-24-XX	24AWG Round Patch Cable, PVC, 1000 feet	Please Call Us

XX = Color	WH	BK	PP	RD	OR
	GY	BL	GN	PK	YL



CAT6 SHIELDED BULK CABLES

CAT6 SHIELDED CABLE

- Four twisted pair with aluminum mylar foil shield, drain wire, ETL/ UL verified, meets CAT6 specifications.
- Solid cable: 24 AWG, solid bare copper, available in gray color only.
- Stranded cable: 26 AWG, stranded (7 x 32) bare copper.
- Available in 8 colors.

06G-R4P-S24-GY-SH

06G-R4P-T24-GY-SH



ORDER CODE	DESCRIPTION	PRICE
06G-R4P-S24-GY-SH	CAT6 STP Cable, 1000 ft, Solid, Gray	Please Call Us
06G-R4P-T24-GY-SH	CAT6 STP Cable, 1000 ft, Stranded	Please Call Us

XX = Color	WH	GY	BK	BL	GN	RD	OR	YL
------------	----	----	----	----	----	----	----	----

BELDEN DATATWIST BULK CABLES

- (A) Belden DataTwist 600e: 4 pair UTP cable, 23 AWG, solid bare copper, e-spline center member, ripcord.



ORDER CODE	DESCRIPTION	PRICE / 1000 FT
BN-7851A-XX	DataTwist 600e, 23AWG Round Cable, PVC	Please Call Us

XX = Jacket Color	WH	DG	BL
-------------------	----	----	----

ORDER CODE	DESCRIPTION	PRICE / 1000 FT
BN-7852A-XX	DataTwist 600e, 23AWG Round Cable, PLENUM	Please Call Us

XX = Jacket Color	WH	BL	GN
-------------------	----	----	----



- (B) Belden DataTwist 6: 4 pair UTP cable, 23 AWG, solid bare copper.

ORDER CODE	DESCRIPTION	PRICE / 1000 FT
BN-2412-XX	DataTwist 6, 23AWG Round Cable, PVC	Please Call Us
BN-2413-YY	DataTwist 6, 23AWG Round Cable, PLENUM	Please Call Us

XX = Jacket Color	WH	GY	BK	BL	PP	GN	RD	OR	YL
-------------------	----	----	----	----	----	----	----	----	----

YY = Jacket Color	WH	GY	BK	BL	PP	GN	RD	OR	YL	PK
-------------------	----	----	----	----	----	----	----	----	----	----

- (C) Belden DataTwist 6: 4 pair UTP cable, 24 AWG, solid bare copper, for patch cables.



Patch Cables

ORDER CODE	DESCRIPTION	PRICE / 1000 FT
BN-7883A-XX	DataTwist 6, 24AWG Round Patch Cable, Solid, PVC	Please Call Us

XX = Jacket Color	WH	BK	PP	RD	OR
	GY	BL	GN	YL	

CAT6 ULTRA FLEXIBLE & FLAT PATCH CABLES

CAT6 ULTRA FLAT PATCH CABLE

- 8P8C RJ-45 Modular Plug, short body, single lay, gold plated 50µ".
- UTP Cat6 cable. 4P*28AWG(7/0.12)
- Bare Copper Insulation: HD-PE.
- PVC outer jacket.

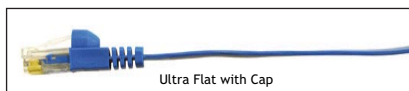

Ultra Flat with Cap



05GR-XX-A-BL-FLAT

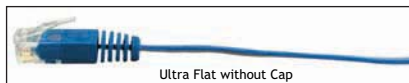

Ultra Flat without Cap



05GE-XX-A-BL-FLAT

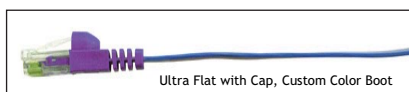

Ultra Flat with Cap, Custom Color Boot



05GR-XX-A-BL/YY-FLAT

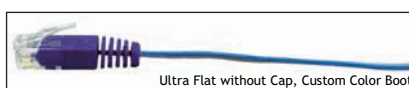

Ultra Flat without Cap, Custom Color Boot



05GE-XX-A-BL/YY-FLAT

ORDER CODE	DESCRIPTION
05GR-XX-A-BL-FLAT	CAT6 Flexible, Flat Patch Cable With Cap
05GE-XX-A-BL-FLAT	CAT6 Flexible, Flat Patch Cable Without Cap
05GR-XX-A-BL/YY-FLAT	CAT6 Flexible, Flat Patch Cable With Cap, Custom Color Boot
05GE-XX-A-BL/YY-FLAT	CAT6 Flexible, Flat Patch Cable Without Cap, Custom Color Boot

CALL FOR PRICE

* Cable color only comes in Blue

XX = Custom Length	YY = Boot Color	WH	GY	BK	BL	PP	GN	RD	OR	YL	PK
--------------------	-----------------	----	----	----	----	----	----	----	----	----	----

CAT6 RJ-45 PLUGS



- Meets EIA/TIA Cat6 specification.
- Staggered conductors guide.
- Works with solid and stranded cables.
- Made in USA.

ORDER CODE	1-499	500-999	1000+
060-R88-T-50-C6	\$0.44	0.42	0.39



- Exceeds EIA/TIA Cat6 specification.
- 3-Pieces type.
- Staggered conductors guide.
- Works with solid and stranded cables.
- Made in China.

ORDER CODE	1-409	500-999	1000+
060-R88-T-50-C6E	\$0.70	0.67	0.62

BOOTS & TOOL

SNAG FREE MULTI-COLOR BOOT FOR RJ45 PLUG

- Works as secondary strain-relief for double security.
- Multi-color body for clear identification of different protocols.
- Keep plug latch from catching onto other cords.
- Applied after termination of RJ-45 plugs.



ZZ = Color
WH = White
GY = Gray
BK = Black
BL = Blue
PP = Purple
GN = Green
RD = Red
OR = Orange
IV = Ivory
YL = Yellow
PK = Pink

ORDER CODE	1-499	500-999	1000+
060-BOOT-SR3-ZZ	\$0.35	0.34	0.31

060-BOOT-SR3-ZZ STRAIN-RELIEF CAP INSTALLATION



MODULAR PLUG CRIMPING TOOL WITH RATCHET

- Works with RJ-11/6P4C, RJ-12/6P6C, and RJ-45/8P8C modular plugs.
- Cuts and strips cable outer jacket, and crimps modular plug in one unit.
- Ratchet design delivers precise, exact crimp.
- Heavy gauge metal frame, sturdy structure.



ORDER CODE	1-9	10-19	20+
061-M-3IN1-R	\$31.68	30.24	28.08



- MOLDED TYPE PLUG: CAT5E 8P8C RJ-45 Short Body Plug with injection molding strain relief caps.
- ASSEMBLY TYPE PLUG: 8P8C RJ-45 Stagger Long Body.
- TESTING: 100% continuity test and AQL 15% attenuation, NEXT, Return Loss, Impedance Test.
- 05BC, 05BK, 05BE, 05BR (UTP) use 24AWG, Stranded (7x32) bare copper, 4-pairs, ETL/UL Verified, meets CAT5E specifications. (06F-R4P-T-24-XX)
- 05BH (STP) use 24AWG, stranded, ETL/UL verified Cat5E Shielded cable.



ASSEMBLY TYPE

ORDER CODE	LENGTH	1-49	50-99	100+
05BC-01-A-XX	1 ft	\$2.11	2.02	1.87
05BC-02-A-XX	2 ft	2.29	2.18	2.03
05BC-03-A-XX	3 ft	2.46	2.35	2.18
05BC-05-A-XX	5 ft	2.82	2.69	2.50
05BC-07-A-XX	7 ft	3.17	3.02	2.81
05BC-10-A-XX	10 ft	3.70	3.53	3.28
05BC-15-A-XX	15 ft	4.58	4.37	4.06
05BC-20-A-XX	20 ft	5.46	5.21	4.84
05BC-25-A-XX	25 ft	6.34	6.05	5.62
05BC-50-A-XX	50 ft	10.74	10.25	9.52
05BC-75-A-XX	75 ft	15.14	14.45	13.42
05BC-100-A-XX	100 ft	19.54	18.65	17.32

• Custom Length: \$1.95 + \$0.18/ft

XX = Color

WH = White
GY = Gray
BK = Black
BL = Blue
PP = Purple
GN = Green
RD = Red
BR = Brown
OR = Orange
IV = Ivory
YL = Yellow
PK = Pink



MOLDED TYPE (SHIELDED)

ORDER CODE	LENGTH	1-49	50-99	100+
05BH-01-A-YY/XX	1 ft	\$4.86	4.64	4.31
05BH-02-A-YY/XX	2 ft	5.14	4.91	4.56
05BH-03-A-YY/XX	3 ft	5.42	5.17	4.80
05BH-05-A-YY/XX	5 ft	5.98	5.71	5.30
05BH-07-A-YY/XX	7 ft	6.55	6.25	5.80
05BH-10-A-YY/XX	10 ft	7.39	7.06	6.55
05BH-15-A-YY/XX	15 ft	8.80	8.40	7.80
05BH-20-A-YY/XX	20 ft	10.21	9.74	9.05
05BH-25-A-YY/XX	25 ft	11.62	11.09	10.30
05BH-50-A-YY/XX	50 ft	18.66	17.81	16.54
05BH-75-A-YY/XX	75 ft	25.70	24.53	22.78
05BH-100-A-YY/XX	100 ft	32.74	31.25	29.02

• Custom Length: \$5.50 + \$0.45/ft

XX = Boot Color

WH = White
GY = Gray
BK = Black
BL = Blue
PP = Purple
GN = Green
RD = Red
OR = Orange
YL = Yellow
PK = Pink

YY = Cable Color

WH = White
GY = Gray
BK = Black
BL = Blue
GN = Green
RD = Red
OR = Orange
YL = Yellow

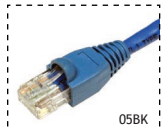

ASSEMBLY TYPE WITH SNAG FREE BOOT

ORDER CODE	LENGTH	1-49	50-99	100+
05BK-01-A-XX	1 ft	\$2.46	2.35	2.18
05BK-02-A-XX	2 ft	2.64	2.52	2.34
05BK-03-A-XX	3 ft	2.82	2.69	2.50
05BK-05-A-XX	5 ft	3.17	3.02	2.81
05BK-07-A-XX	7 ft	3.52	3.36	3.12
05BK-10-A-XX	10 ft	4.05	3.86	3.59
05BK-15-A-XX	15 ft	4.93	4.70	4.37
05BK-20-A-XX	20 ft	5.81	5.54	5.15
05BK-25-A-XX	25 ft	6.69	6.38	5.93
05BK-50-A-XX	50 ft	11.09	10.58	9.83
05BK-75-A-XX	75 ft	15.49	14.78	13.73
05BK-100-A-XX	100 ft	19.89	18.98	17.63

• Custom Length: \$2.40 + \$0.18/ft

XX = Color

WH = White
GY = Gray
BK = Black
BL = Blue
PP = Purple
GN = Green
RD = Red
BR = Brown
OR = Orange
IV = Ivory
YL = Yellow
PK = Pink

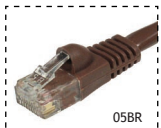

MOLDED TYPE WITH SNAG FREE BOOT

ORDER CODE	LENGTH	1-49	50-99	100+
05BR-01-A-XX	1 ft	\$2.99	2.86	2.65
05BR-02-A-XX	2 ft	3.17	3.02	2.81
05BR-03-A-XX	3 ft	3.34	3.19	2.96
05BR-05-A-XX	5 ft	3.70	3.53	3.28
05BR-07-A-XX	7 ft	4.05	3.86	3.59
05BR-10-A-XX	10 ft	4.58	4.37	4.06
05BR-15-A-XX	15 ft	5.46	5.21	4.84
05BR-20-A-XX	20 ft	6.34	6.05	5.62
05BR-25-A-XX	25 ft	7.22	6.89	6.40
05BR-50-A-XX	50 ft	11.62	11.09	10.30
05BR-75-A-XX	75 ft	16.02	15.29	14.20
05BR-100-A-XX	100 ft	20.42	19.49	18.10

• Custom Length: \$3.00 + \$0.18/ft

XX = Color

WH = White
GY = Gray
BK = Black
BL = Blue
PP = Purple
GN = Green
RD = Red
BR = Brown
OR = Orange
IV = Ivory
YL = Yellow
PK = Pink

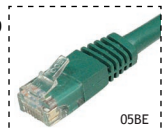

MOLDED TYPE WITH SNAG FREE BOOT

ORDER CODE	LENGTH	1-49	50-99	100+
05BE-01-A-XX	1 ft	\$2.99	2.86	2.65
05BE-02-A-XX	2 ft	3.17	3.02	2.81
05BE-03-A-XX	3 ft	3.34	3.19	2.96
05BE-05-A-XX	5 ft	3.70	3.53	3.28
05BE-07-A-XX	7 ft	4.05	3.86	3.59
05BE-10-A-XX	10 ft	4.58	4.37	4.06
05BE-15-A-XX	15 ft	5.46	5.21	4.84
05BE-20-A-XX	20 ft	6.34	6.05	5.62
05BE-25-A-XX	25 ft	7.22	6.89	6.40
05BE-50-A-XX	50 ft	11.62	11.09	10.30
05BE-75-A-XX	75 ft	16.02	15.29	14.20
05BE-100-A-XX	100 ft	20.42	19.49	18.01

• Custom Length: \$3.00 + \$0.18/ft

XX = Color

WH = White
GY = Gray
BK = Black
BL = Blue
PP = Purple
GN = Green
RD = Red
BR = Brown
OR = Orange
IV = Ivory
YL = Yellow
PK = Pink

DATATWIST 350 - MOLDED PATCH CABLES



- Belden's exclusive DataTwist® 350 cable - stable performance up to 350MHz. All cables are AT&T 258A (568B) wiring. (568A wiring or other lengths are available upon request.)
- Molded strain relief ensures connection, keeps cable within CAT5e bending radius.
- Molded snag-free cap and jacket available in 11 different colors.
- Tri-Net's exclusive short body RJ-45 plug, lowest NEXT in its class.
- 50µ" gold plating on the contacts - Full FCC part 68 compliance.

ORDER CODE	LENGTH	WIRING	1-49	50-99	100+
05A-01-A-XX	1 ft	568B (258A)	\$3.98	3.80	3.53
05A-02-A-XX	2 ft	568B (258A)	4.44	4.23	3.93
05A-03-A-XX	3 ft	568B (258A)	4.89	4.67	4.34
05A-05-A-XX	5 ft	568B (258A)	5.81	5.54	5.15
05A-07-A-XX	7 ft	568B (258A)	6.72	6.42	5.96
05A-10-A-XX	10 ft	568B (258A)	8.10	7.73	7.18
05A-14-A-XX	14 ft	568B (258A)	9.93	9.48	8.80
05A-20-A-XX	20 ft	568B (258A)	12.67	12.10	11.23
05A-25-A-XX	25 ft	568B (258A)	14.96	14.28	13.26
05A-50-A-XX	50 ft	568B (258A)	26.40	25.20	23.40
05A-75-A-XX	75 ft	568B (258A)	37.84	36.12	33.54
05A-100-A-XX	100 ft	568B (258A)	49.28	47.04	43.68

• Custom Length: \$3.60 + \$0.48/ft

XX = Color BK BL PP GN RD OR YL IV

CAT5E ULTRA FLEXIBLE PATCH CABLES

CAT5E FLAT PATCH CABLE

- 8P8C RJ-45 Modular Plug, short body, single lay, gold plated 50µ".
- UTP Cat5E cable. 4P*28AWG(7/0.12)
- Bare Copper Insulation: HD-PE.
- PVC outer jacket.

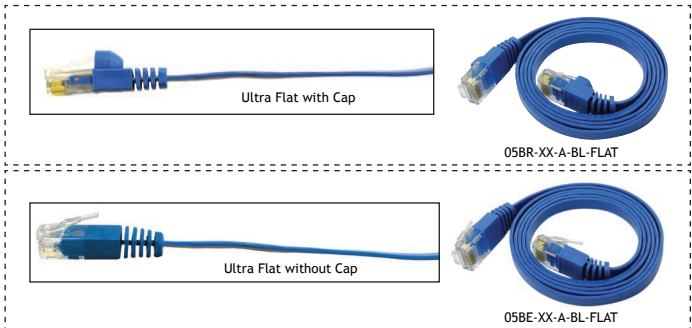

* Cable color only comes in Blue. * Also available in custom boot color. === CALL FOR PRICE ===

ORDER CODE	DESCRIPTION	PRICE
05BR-XX-A-BL-FLAT	CAT5E Flat Patch Cable With Cap	\$3.00 + 0.30/ft
05BE-XX-A-BL-FLAT	CAT5E Flat Patch Cable Without Cap	3.00 + 0.30/ft
05BR-XX-A-BL/YY-FLAT	CAT5E Flat Patch Cable With Cap, Custom Boot Color	3.00 + 0.30/ft
05BE-XX-A-BL/YY-FLAT	CAT5E Flat Patch Cable Without Cap, Custom Boot Color	3.00 + 0.30/ft

CAT5E THIN PATCH CABLE

- 8P8C RJ-45 Modular Plug, short body, single lay, gold plated 50µ".
- UTP Cat5E cable. 4P*28AWG(7/0.12)
- Bare Copper Insulation: HD-PE.
- PVC outer jacket.

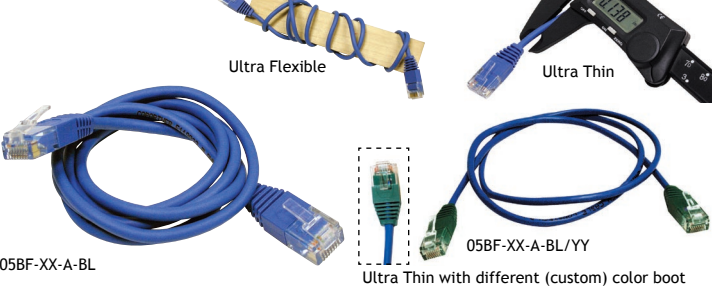

* Cable color only comes in Blue

ORDER CODE	DESCRIPTION	PRICE
05BF-XX-A-BL	CAT5E Flexible, Thin Patch Cable	\$3.00 + 0.25/ft
05BF-XX-A-BL/YY	CAT5E Flexible, Thin Patch Cable, Custom Color Boot	3.00 + 0.25/ft

CAT5E RJ-45, 110-TYPE PATCH PANEL

- ETL/UL Cat5E verified; UL 1863.
- Exceeds EIA/TIA TSB 40A connecting hardware specification.
- Space saving, high density 19" panel design.
- PCB type 110 termination.



ORDER CODE	DESCRIPTION	1-4	5-9	10+
01BR-12	Cat5E RJ45 to 110 Patch Panel, 12 Port, 1U (1.75" high)	\$35.20	33.60	31.20
01BR-24	Cat5E RJ45 to 110 Patch Panel, 24 Port, 1U (1.75" high)	49.28	47.04	43.68
01BR-48	Cat5E RJ45 to 110 Patch Panel, 48 Port, 2U (3.50" high)	79.20	75.60	70.20

CAT5E SUPER HIGH DENSITY 110 PATCH PANEL



- Installation-friendly, upper and lower level ports are built separately in a strain relief tray
- User-friendly hand-screw for releasing/fastening the upper level, requiring no tools.
- Helps to lower the hardware cost by putting 48 ports in 1U panel.



ORDER CODE	1-4	5-9	10+
01BS-48	\$169.84	162.12	150.54

CAT5E, 89D BRACKET TYPE 110 PANEL, 12-PORT

- 89D Type bracket, surface mountable.
- For small voice and data connections.

ORDER CODE	WIRING	1-9	10-19	20+
01BR-12-WM	258A Wiring	\$31.68	30.24	28.08



CAT5E RJ-45 FEED-THROUGH PANEL

- 19" panel, loaded with Cat5E in-line couplers.

ORDER CODE	# PORTS	HEIGHT	1-4	5-9	10+
01E-08	8	1.75"	\$73.92	70.56	65.52
01E-12	12	1.75"	96.80	92.40	85.80
01E-16	16	1.75"	119.68	114.24	106.08
01E-24	24	3.50"	168.96	161.28	149.76
01E-32	32	3.50"	205.92	196.56	182.52
01E-48	48	5.25"	306.24	292.32	271.44

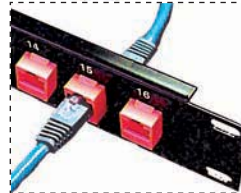

CAT5E, RJ-45 FEED THROUGH PANEL

- 19" wide black color, 1/16" thick steel panel.
- Clear white silk screen number on the panel.
- Cat5E, RJ-45 in-line coupler snapped on to the panel.
- Black color bezels hold the coupler flush with the front panel.

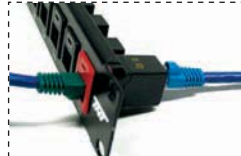

ORDER CODE	# OF PORTS	RACK SPACE #	HEIGHT	1-4	5-9	10+
015-008-RJ45	8	1	1.75"	\$73.92	70.56	65.52
015-012-RJ45	12	1	1.75"	98.56	94.08	87.36
015-016-RJ45	16	1	1.75"	123.20	117.60	109.20
015-024-RJ45	24	2	3.50"	176.00	168.00	156.00
015-032-RJ45	32	2	3.50"	220.00	210.00	195.00
015-048-RJ45	48	3	5.25"	308.00	294.00	273.00

1U (1 3/4") & 2U (3 1/2") HIGH DENSITY 16 / 24 / 48-PORT FEED-THRU PANEL

- 19" wide black color, 1/8" thick steel panel.
- Clear white silk screen number on the panel.
- Mini couplers can be loaded: RJ-12, RJ-45, Cat5E, Cat6.



ORDER CODE	DESCRIPTION	1-4	5-9	10+
016-016-B	1U 16-Port Blank Panel (Flush Type)	\$30.80	29.40	27.30
016-024-B	1U 24-Port Blank Panel (Flush Type)	35.20	33.60	31.20
016-048-B	2U 48-Port Blank Panel (Flush Type)	49.28	47.04	43.68
016-016-C5E	1U 16-Port Panel - Cat5E Couplers Loaded	105.60	100.80	93.60
016-024-C5E	1U 24-Port Panel - Cat5E Couplers Loaded	174.24	166.32	154.44
016-048-C5E	2U 48-Port Panel - Cat5E Couplers Loaded	308.00	294.00	273.00

90° & 180° MINI KEYSTONE JACKS

- Compliant with EIA / TIA specifications.
- Dual color-coded labels for 568A and 568B wiring schemes.
- Uniquely patented PCB (Printed Circuit Board) design.
- Snap-in type enclosure allows easy mounting onto wall plates or panels.
- Compact style, fits into 016-024 / 016-048 panels.

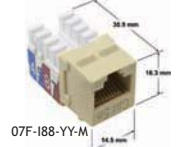

ORDER CODE	DESCRIPTION	1-49	50-99	100+
07F-I66-YY-M	RJ-12 90° Mini Keystone Jack	1.94	1.85	1.72
07B-I88-YY-M	Cat5E 180° Mini Keystone Jack	2.64	2.52	2.34
07F-I88-YY-M	Cat5E 90° Mini Keystone Jack	2.46	2.35	2.18

XX = Color	WH	GY	BK	BL	GN	RD	OR	YL	IV
------------	----	----	----	----	----	----	----	----	----

5-PAIR 110 PUNCH DOWN TOOL

- Reduce 110-type LAN and telecommunication distribution system installation time.
- Used on both cable and cross-connect sides of 110-type termination block.
- Terminates and cuts up to five pairs of UTP at the same time.
- Rubber handle design provides comfortable use.
- Features reversible blades for seating conductors without cutting.



ORDER CODE	1-9	10-19	20+
061-315DR	\$80.96	77.28	71.76

TERMINATION TOOL FOR CAT5E 180° TOP-ENTRY MINI KEYSTONE JACK

- Termination and Wire-Cutting Tool for Top-Entry Keystone Jack Module
- Works with Cat5e 180° Mini Keystone Jacks (P/N: 07B-I88-YY-M)



ORDER CODE	1-9	10-19	20+
061-07B-OR	\$51.92	49.56	46.02



TERMINATION TOOL FOR CAT5E 90° RIGHT-ANGLED MINI KEYSTONE JACK

- Termination and Wire-Cutting Tool for Right-Angled Keystone Jack Module
- Works with Cat5e 90° Mini Keystone Jacks (P/N: 07F-I88-YY-M)



ORDER CODE	1-9	10-19	20+
061-07F-BL	\$51.92	49.56	46.02



FACE PLATES (07M)

MULTI-PORT FACE PLATES (07M)

- Single gang face plates with 1/2/3/4/6 cutouts, Double gang face plates with 4/8 cutouts.
- Built-in recessed designation strips with clear plastic covers for system or station ID.
- Attachable color icon and sticker type label.



ORDER CODE	# CUTOUTS	# GANG	1-49	50-99	100+
07M-101-XX	1	Single	\$0.79	0.76	0.70
07M-102-XX	2	Single	0.79	0.76	0.70
07M-103-XX	3	Single	0.79	0.76	0.70
07M-104-XX	4	Single	0.79	0.76	0.70
07M-106-XX	6	Single	0.79	0.76	0.70
07M-124-XX	4	Double	1.94	1.85	1.72
07M-128-XX	8	Double	1.94	1.85	1.72

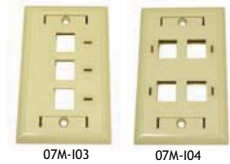

XX = Color	WH = White	GY = Gray	IV = Ivory
------------	------------	-----------	------------



FACE PLATES (071)

FACE PLATES (071)

- Single gang face plates with 1/2/3/4/6 cutouts.
- Double gang face plates with 12 cutouts.



ORDER CODE	DESCRIPTION	1-49	50-99	100+
071-101-XX	1 Cutout	\$0.60	0.57	0.53
071-102-XX	2 Cutouts	0.60	0.57	0.53
071-103-XX	3 Cutouts	0.60	0.57	0.53
071-104-XX	4 Cutouts	0.60	0.57	0.53
071-106-XX	6 Cutouts	0.60	0.57	0.53
071-1212-IV/WH	12 Ports Double Gang Face Plate	1.94	1.85	1.72

XX = Color	WH = White	GY = Gray	IV = Ivory
------------	------------	-----------	------------

CAT5E PLUGS

CAT5E RJ-45 PLUGS WITH STAGGER CONDUCTORS GUIDE

- Exclusive stagger conductors guide design reduces near end cross talk (NEXT).
- Meets EIA/TIA 568A Cat5E specification.
- Works for both solid and stranded wires.

ORDER CODE	1-499	500-999	1000+
060-R88-T50-C5E	\$0.32	0.30	0.28



EZ-RJ45™ CONNECTOR

- No handle liner or wire bar to deal with. Verification of the correct conductor order is done before crimping so no connector is wasted because of incorrect wiring.
- The conductors can be pulled forward so the pairs are very close to the contacts - ensuring the integrity of the pairs to maintain Cat 5, and even Cat5E capabilities.
- Can be crimped with most any standard tool, then trimmed with a cutter or small utility knife.
- Packaging: 50 piece per bag or 250 pieces per bag.

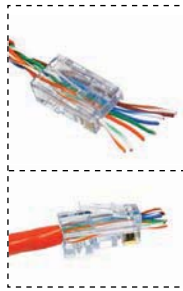

ORDER CODE	DESCRIPTION	1-9	10-19	20+
060-EZRJ45-50	50pcs/pk	\$44.00	42.00	39.00
060-EZRJ45-250	250pcs/pk	198.00	189.00	175.50

MOUNTING BOXES/JACKS

KEYSTONE JACK SURFACE MOUNT BOXES

- Compatible with virtually all keystone jacks in the industry (e.g. AMP, TNT, Leviton).
- Recessed designation strips with plastic cover for system or station ID.
- Color plastic icons attachable.
- Double sided tape and mounting hardware included.

ORDER CODE	DESCRIPTION	1-49	50-99	100+
077-SBX-1-XX	Single Port	\$1.14	1.09	1.01
077-SBX-2-XX	Dual Ports	1.41	1.34	1.25

XX = Color WH IV

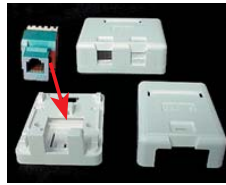

(Keystone jack not included)

UNIVERSAL SURFACE MOUNTING BOXES

- Surface mount boxes for 071 and 07M series single and double gang face plates.

ORDER CODE	DESCRIPTION	1-49	50-99	100+
071-BOX-XX	Single Gang	\$2.55	2.44	2.26
071-BOX2-XX	Double Gang	5.19	4.96	4.60

XX = Color WH IV

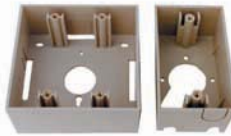

ENHANCED CAT5 RJ-45 SURFACE MOUNT JACKS

- UL Verified CAT5E.
- 110 type IDC termination.
- 6-port version is ideal for terminating with 25-pair cables.
- AT&T 258A (568B) Wiring.
- Station ID strip.



ORDER CODE	# RJ-45'S	1-24	25-49	50+
074-S-01-258A-XX	1	\$3.70	3.53	3.28
074-S-02-258A-XX	2	5.98	5.71	5.30
074-S-06-258A-IV	6	21.12	20.16	18.72

XX = Color WH IV

110 CABLE ASSEMBLIES

CAT5 - 110 TO 110 CABLE ASSEMBLY

- 110 plugs in 1, 2, 3, or 4-pair sizes.
- CAT5e, 24 AWG, Stranded, Unshielded Twisted Pair cable.
- Custom wiring or length is available upon request.



ORDER CODE	DESCRIPTION	UNIT PRICE
093-2-XX	1-Pair, 110/110	\$5.50 + \$0.13/ft
093-4-XX	2-Pair, 110/110	6.60 + \$0.13/ft
093-6-XX	3-Pair, 110/110	6.80 + \$0.14/ft
093-8-XX	4-Pair, 110/110	8.80 + \$0.14/ft

XX = Cable Length

CAT5 - 110 TO RJ-11 / RJ-12 / RJ-45 CABLE ASSEMBLY

- Plug 1: 110 plug; 1, 2, 3, or 4-pair sizes.
- Plug 2: RJ-45, RJ-12, or RJ-11.
- Cable: CAT5e, 24 AWG, Stranded, Unshielded Twisted Pair Cable.
- Custom wiring or length is available upon request.



ORDER CODE	DESCRIPTION	UNIT PRICE
092-211-U-XX	1-Pair, 110/RJ-11 Plugs, USOC	\$3.60 + \$0.13/ft
092-411-U-XX	2-Pair, 110/RJ-11 Plugs, USOC	4.40 + \$0.13/ft
092-612-U-XX	3-Pair, 110/RJ-12 Plugs, USOC	5.20 + \$0.14/ft
092-445-T-XX	2-Pair, 110/RJ-45 Plugs, 10Base-T	4.80 + \$0.13/ft
092-845-A-XX	4-Pair, 110/RJ-45 Plugs, 258A	6.80 + \$0.14/ft
092-845-E-XX	4-Pair, 110/RJ-45 Plugs, 568A	6.80 + \$0.14/ft

XX = Cable Length

CAT5E IN-LINE COUPLERS

CAT5E 110-PUNCH DOWN TYPE IN-LINE COUPLER

- Designed to extend or to fan out CAT5E 4-pair cable without RJ45 connection.
- Wiring Scheme: pin to pin, 568A and/or 568B(258A) standard.
- Internal PCB (Printed Circuit Board) structure with plastic enclosure - meets EIA/TIA 568A Cat5E specifications.
- Color-coded 110 type terminal.
- Surface mountable enclosure with cable tie holes.



ORDER CODE	1-49	50-99	100+
080-110-4	\$3.52	3.36	3.12

CAT5E RJ-45 IN-LINE COUPLER

- Meets EIA/TIA 568A Cat5E specifications.
- The most compact RJ-45 in-line coupler.
- Patented Printed Circuit Board design.



ORDER CODE	1-49	50-99	100+
080-RJ45-C5	\$3.87	3.70	3.43



CAT5E PANEL MOUNT MINI COUPLER

- RJ-45; 8P8C Female to Female.
- PCB design; Panel mountable.



ORDER CODE	1-49	50-99	100+
080-885-C5-M	\$3.87	3.70	3.43



CAT5E SHIELDED MINI COUPLER

- Straight-thru pin-to-pin wiring configuration.
- Superior PCB design ensures highest performance.
- Meets EIA / TIA 568A Cat5E specifications.
- Snap-in type enclosure.

ORDER CODE	1-49	50-99	100+
080-C5E-SI-SH-M	\$4.75	4.54	4.21

CAT5E ADAPTERS

CATEGORY 5E T-ADAPTER

- Designed to split one CAT5E 4-pair cable into two connections.
- Internal PCB (Printed Circuit Board) structure - meets EIA/TIA 568A Cat5E specifications.
- Pig-tail cable: Cat5E stranded, 6" long.
- Identification icons included.



T-ADAPTER 085-T-C5E

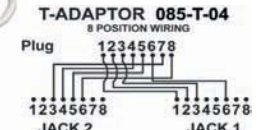
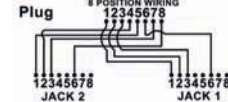

ORDER CODE	DESCRIPTION	1-49	50-99	100+
085-T-C5E	Cat5E T Adapter	\$5.28	5.04	4.68
085-T-04	10/100 Base TX/Token Ring Wiring	5.63	5.38	4.99
085-T-07	All 8 Wires	5.98	5.71	5.30

100 BASE-TX CROSS OVER ADAPTER

- Pin 1, 2/3, 6 crossover; ideal for Hub to Hub cascade, or station to station connection.
- Printed Circuit Board design ensures CAT5E performance.



ORDER CODE	1-49	50-99	100+
080-88-CR-C5	\$3.87	3.70	3.43

110 CONNECTORS

1, 2, 3 AND 4-PAIR 110 PATCH PLUGS • AT&T equivalent design.

ORDER CODE	DESCRIPTION	AT&T PART#	1-49	50-99	100+
094-1	1-Pair	PC110-2	\$1.58	1.51	1.40
094-2	2-Pair	PC110-4	1.67	1.60	1.48
094-3	3-Pair	PC110-6	2.11	2.02	1.87
094-4	4-Pair	PC110-8	2.82	2.69	2.50

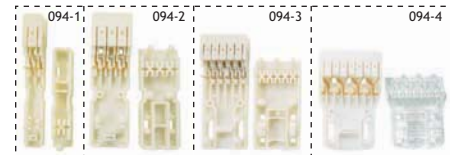

3, 4 AND 5 PAIR 110 CONNECTING BLOCKS

ORDER CODE	DESCRIPTION	AT&T PART #	1-49	50-99	100+
096-110C3	3-Pair	110C-3	\$0.88	0.84	0.78
096-110C4	4-Pair	110C-4	0.88	0.84	0.78
096-110C5	5-Pair	110C-5	1.14	1.09	1.01

MEDIA TWIST 550MHZ

MEDIA TWIST: UNIVERSAL UTP CABLE FOR VIDEO, DATA, & VOICE.

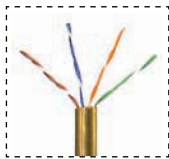

BN-1872A



BN-1874A



BN-1875GB-XX

- A UTP cabling for multimedia applications. Tested and certified on multiple systems above 100 MHz.
- The only UTP cable manufactured intentionally to achieve both conductor-to-conductor and pair-to-pair stability.
- 4-pair cable with extremely uniform dimensions and internal physical spacing.
- Delivers stable performance to 550 MHz, with electrical characteristics exceeding TIA/EIA Cat5e standards; ideal for Gigabit Ethernet, ATM, and Video channel applications.
- Unique crescent shape design - each pair is "locked" into place - ensures that pair-to-pair movement is greatly minimized during installation process.

ORDER CODE	DESCRIPTION	PRICE / 1000 FT
BN-1872A	Media Twist, Solid, PVC, GOLD Color, 1000 feet	Please Call Us
BN-1874A	Media Twist, Solid, Plenum, BLUE Color, 1000 feet	Please Call Us
BN-1875GB-XX	Media Twist, Stranded, 4-Pair, 568B (258A), 1000 feet	Please Call Us

XX = Color	WH	BK	PP	RD	OR
	GY	BL	GN	IV	YL

PREMISE WIRING

• For large quantity orders, please call for price discounts.



BN-1583A-XX



BN-1585A-XX



BN-785(1/2)A-XX



BN-2412

BN-2413



BN-7883A-XX



ORDER CODE	DESCRIPTION	PRICE / 1000 FT
BN-1583A-XX	CAT5E, 4 Pair, 24 AWG, Solid, PVC, 1000 feet / Box	Please Call Us

XX = Color	WH	GY	BK	BL	GN	RD	OR	YL	PK
------------	----	----	----	----	----	----	----	----	----

BN-1585A-XX	CAT5E, 4 Pair, 24 AWG, Solid, Plenum, 1000feet / Box	Please Call Us
-------------	--	----------------

XX = Color	WH	GY	BL
------------	----	----	----

BN-2412-XX	DataTwist 6, PVC, Solid, 23 AWG, 1000 feet / Box	Please Call Us
------------	--	----------------

BN-2413-YY	DataTwist 6, Plenum, Solid, 23 AWG, 1000 feet / Box	Please Call Us
------------	---	----------------

BN-7883A-XX	DataTwist 6, 4 Pair, 24 AWG, Solid, 1000 feet / Reel	Please Call Us
-------------	--	----------------

XX = Color	WH	GY	BK	BL	PP	GN	RD	OR	YL
------------	----	----	----	----	----	----	----	----	----

YY = Color	WH	GY	BK	BL	PP	GN	RD	OR	YL	PK
------------	----	----	----	----	----	----	----	----	----	----

BN-7851A-XX	DataTwist 600e, PVC, Solid, 23 AWG, 1000 feet / Box	Please Call Us
-------------	---	----------------

XX = Color	WH	DG	BL
------------	----	----	----

BN-7852A-XX	DataTwist 600e, Plenum, Solid, 23 AWG, 1000 feet / Box	Please Call Us
-------------	--	----------------

XX = Color	WH	BL	GN
------------	----	----	----

BN-1227A	CAT3, 2 Pair; GY = GRAY	Please Call Us
----------	-------------------------	----------------

BN-1229A	CAT3, 4 Pair, 24 AWG, Solid, PVC, 1000 feet / Box	Please Call Us
----------	---	----------------

BN-1232A1	CAT3, 25 Pair, 24 AWG, Solid, PVC 1000 feet / Reel	Please Call Us
-----------	--	----------------

COMTRAN BULK CABLES



COM-2631

ORDER CODE	DESCRIPTION	PRICE / 1000 FT
COM-2222	CAT3, 4-Pair, Plenum, GRAY	PLEASE CALL US FOR PRICING
COM-2631	CAT3, 25-Pair, Plenum	
COM-2347	CAT5E, 4-Pair, Plenum, WHITE	
COM-2756	CAT5E, 4-Pair, Plenum, BLUE	
COM-2820	CAT5E, 4-Pair, Plenum, YELLOW	
COM-2883	CAT5E, 4-Pair, PVC, BLUE	
COM-3559	CAT3, 2-Pair, PVC	
COM-3561	CAT3, 4-Pair, PVC	
COM-3570	CAT3, 25-Pair, PVC	
COM-3572	CAT3, 50-Pair, PVC	
COM-3574	CAT3, 100-Pair, PVC	

CAT5E 350MHZ SHIELDED CABLE

- Four twisted pair with aluminum mylar foil shield, drain wire, ETL/UL verified, meets Category 5E specifications, tested to 350MHz.
- Solid Cable : 24AWG, solid bare copper, available in GRAY color only.
- Stranded Cable : 24AWG, stranded (7 x 32) bare copper. Available in 6 colors.

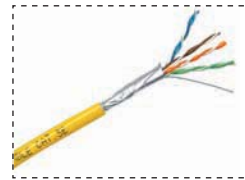

ORDER CODE	DESCRIPTION	PRICE / 1000 FT
06F-R4P-S24-GY-SH	Cat5E 350 MHz shielded, 4 pair, solid cable, 1000 feet, Gray	Please Call Us
06F-R4P-T24-XX-SH	Cat5E 350 MHz shielded, 4 pair, stranded cable, 1000 feet	Please Call Us

XX = Color	WH	GY	BK	BL	GN	RD	OR	YL
------------	----	----	----	----	----	----	----	----

BELDEN CAT5E COLOR SHIELDED CABLE - SOLID

- Premise Horizontal Cable.
- Cable: 4 pair ScTP, 200MHz Category 5E, Riser Rated, 24 AWG solid Bare Copper, foil shield bonded to the Jacket, 24 AWG drain wire.
- Available in PVC and Plenum jacket.

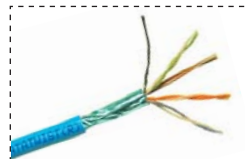

ORDER CODE	DESCRIPTION	PRICE / 1000 FT
BN-1533R-XX	Cat5E 200 MHz shielded, 4 pair, solid cable, 1000 feet, PVC	Please Call Us
BN-1533P-YY	Cat5E 200 MHz shielded, 4 pair, solid cable, 1000 feet, Plenum	Please Call Us

XX = Color	BK	BL	GN	RD	OR	YL	IV
------------	----	----	----	----	----	----	----

YY = Color	WH	GY	BK	BL	GN	RD	OR	YL
------------	----	----	----	----	----	----	----	----

DataTwist 350

DATATWIST 350 BULK CABLES 1000 FT.



ORDER CODE	DESCRIPTION	PRICE / 1000 FT
BN-1700A	DataTwist 350, 4-Pair PVC, Solid, BLUE	Please Call Us
BN-1701A	DataTwist 350, 4-Pair Plenum, Solid, WHITE	Please Call Us
BN-1752A-XX	DataTwist 350, 4-Pair PVC, Stranded	Please Call Us

XX = Color	BK	PP	RD	OR
	BL	GN	IV	YL

CAT5E STRANDED UTP BULK CABLE

- 24 AWG, Stranded bare Copper.
- 1000 feet/box.



ORDER CODE	DESCRIPTION	PRICE / 1000 FT
06F-R2P-T-24-XX	Cat5E, 2-Pair	Please Call Us
06F-R4P-T-24-YY	Cat5E, 350Mhz, 4-Pair	Please Call Us

XX = Color	GY	BK
------------	----	----

YY = Color	WH	BK	PP	RD	OR	IV
	GY	BL	GN	BR	YL	PK

25 PAIR CABLE

- PVC version, 24 AWG.
- Plenum 25 Pair Cable also available.



ORDER CODE	DESCRIPTION	PRICE / 1000 FT
BN-1864A	CAT5, 25-Pair, 24AWG, Solid, PVC 1000 feet / Reel, BLUE and GRAY DEC	Please Call Us

NETWORK CABLE TESTER

- Tests for RJ-45 modular connection with 258A, 568A and B, 356A wiring and 10Base-T, RJ-12 and RJ-11 USOC wiring and coaxial cables with BNC connectors.
- Performs tests of cable continuity, miss-wiring and polarization by the color of large-sized LEDs.
- Kit includes one master and one remote unit, one BNC adapter, two BNC/F adapters, and a carry case.
- Detachable remote unit for installed cabling.
- Additional Remote Module Unit is available.



ORDER CODE	1-9	10-19	20+
069-TNT-N	\$28.16	26.88	24.96

TRUE CAT5 25 - PAIR TRUNK CABLE - BELDEN CABLE

CATEGORY 5 25-PAIR CABLE ASSEMBLY (BELDEN)

- Exceeds EIA/TIA 568A CAT5 requirement by an average factor of 6 dB above.
- CAT5 Avaya 525 Telco 50 pin male or female connectors.
- Cable: Belden 1864A CAT5 25 pair PVC.
- Plenum cable is available upon request



TRUNK CABLE ASSEMBLY

- Male connectors both ends, PVC cable.

ORDER CODE	DESCRIPTION	1-4	5-9	10+
04C-11-MM-05	180° to 180°, 5 feet	\$61.75	59.00	57.50
04C-19-MM-05	180° to 90°, 5 feet	61.75	59.00	57.50
04C-1(4/4 _R)-MM-05	180° to 45°, 5 feet	61.75	59.00	57.50
04C-(4/4 _R)(4/4 _R)-MM-05	45° to 45°, 5 feet	61.75	59.00	57.50
04C-(4/4 _R)9-MM-05	45° to 90°, 5 feet	61.75	59.00	57.50
04C-99-MM-05	90° to 90°, 5 feet	61.75	59.00	57.50

CUSTOM LENGTH: 04C-(X,X₂)-MM-(length in feet) - PVC - \$55.00 + \$1.35/ft
 X₁ and X₂ = Connector Type; 1 = 180°, 9 = 90°, 4_L = 45° (left angle), 4_R = 45° (right angle).

- Male connector one end, Female the other end, PVC cable.

ORDER CODE	DESCRIPTION	1-4	5-9	10+
04C-19-MF-05	180° (M) to 90° (F), 5 feet	\$61.75	59.00	57.50
04C-(4/4 _R)9-MF-05	45° (M) to 90° (F), 5 feet	61.75	59.00	57.50
04C-99-MF-05	90° (M) to 90° (F), 5 feet	61.75	59.00	57.50

CUSTOM LENGTH: 04C-(X,X₂)-MF-(length in feet) - PVC - \$55.00 + \$1.35/ft
 X₁ = Male Connector Type; 1 = 180°, 9 = 90°, 4_L = 45° (left angle), 4_R = 45° (right angle).

- Male connector one end, open the other end, PVC cable.

ORDER CODE	DESCRIPTION	1-4	5-9	10+
04C-10-M-05	180° to Open, 5 feet	\$34.25	33.50	32.50
04C-(4/4 _R)0-M-05	45° to Open, 5 feet	34.25	33.50	32.50
04C-90-M-05	90° to Open, 5 feet	34.25	33.50	32.50

CUSTOM LENGTH: 04C-(X)0-M-(length in feet) - PVC - \$27.50 + \$1.35/ft
 X = Connector Type; 1 = 180°, 9 = 90°, 4_L = 45° (left angle), 4_R = 45° (right angle).

- Female connectors both ends, PVC cable.

ORDER CODE	DESCRIPTION	1-4	5-9	10+
04C-99-FF-05	90° (F) to 90° (F), 5 feet	\$61.75	59.00	57.50

CUSTOM LENGTH: 04C-99-FF-(length in feet) - PVC - \$55.00 + \$1.35/ft

TRUE CAT5 OCTOPUS CABLES

TRUE CATEGORY 5 OCTOPUS CABLE

- Composed of Avaya's 525 Telco 50 pin connector with Cat 5 stranded cable.
- Male Telco 50 pin connector with 45° (left or right angle), 90°, or 180° hoods.
- 6 or 12 legs with RJ-45 connectors.
- Female 50 pin connector in 90° hood only.



ORDER CODE	WIRING	HOOD	# LEGS	PRICE
03B-806-M9-A-XX	258A (568B)	90° Male	6	\$50.00 + \$1.00/ft
03B-806-F9-A-XX	258A (568B)	90° Female	6	50.00 + 1.00/ft
03B-806-M1-A-XX	258A (568B)	180° Male	6	50.00 + 1.00/ft
03B-806-M(4L/4R)-A-XX	258A (568B)	45° (left/right)	6	50.00 + 1.00/ft
03B-806-M9-E-XX	568A	90° Male	6	50.00 + 1.00/ft
03B-806-F9-E-XX	568A	90° Female	6	50.00 + 1.00/ft
03B-806-M1-E-XX	568A	180° Male	6	50.00 + 1.00/ft
03B-806-M(4L/4R)-E-XX	568A	45° (left/right)	6	50.00 + 1.00/ft
03B-412-M9-T-XX	100Base-TX	90° Male	12	50.00 + 1.50/ft
03B-412-F9-T-XX	100Base-TX	90° Female	12	50.00 + 1.50/ft
03B-412-M1-T-XX	100Base-TX	180° Male	12	50.00 + 1.50/ft
03B-412-M(4L/4R)-T-XX	100Base-TX	45° (left/right)	12	50.00 + 1.50/ft

XX = Length of Cable (feet)

25 - PAIR TRUNK / OCTOPUS CABLES

25-PAIR TRUNK CABLE (USE AMP CHAMP CONNECTOR)

- Category 3 or 5, 24 AWG Solid Twisted Pair cable; PVC or Plenum.
- Custom lengths are available upon request.



ORDER CODE	DESCRIPTION	1-4	5-9	10+
040-X-X ₁ -(Gender)-05	CAT3, 5 feet, PVC	\$22.88	21.84	20.28
040-X-X ₁ -(Gender)-10	CAT3, 10 feet, PVC	28.16	26.88	24.96
040-X-X ₁ -(Gender)-20	CAT3, 20 feet, PVC	38.72	36.96	34.32
040-X-X ₁ -(Gender)-YY	Custom Length, PVC		\$18.00 + \$1.10/ft	
041-X-X ₁ -(Gender)-05	CAT3, 5 feet, Plenum			Please Call for Price
041-X-X ₁ -(Gender)-10	CAT3, 10 feet, Plenum			Please Call for Price
041-X-X ₁ -(Gender)-20	CAT3, 20 feet, Plenum			Please Call for Price
041-X-X ₁ -(Gender)-YY	Custom Length, Plenum			Please Call for Price
042-X-X ₁ -(Gender)-05	CAT5, 5 feet, PVC	29.04	27.72	25.74
042-X-X ₁ -(Gender)-10	CAT5, 10 feet, PVC	36.96	35.28	32.76
042-X-X ₁ -(Gender)-20	CAT5, 20 feet, PVC	52.80	50.40	46.80
042-X-X ₁ -(Gender)-YY	Custom Length, PVC		\$22.00 + \$1.35/ft	
043-X-X ₁ -(Gender)-05	CAT5, 5 feet, Plenum			Please Call for Price
043-X-X ₁ -(Gender)-10	CAT5, 10 feet, Plenum			Please Call for Price
043-X-X ₁ -(Gender)-20	CAT5, 20 feet, Plenum			Please Call for Price
043-X-X ₁ -(Gender)-YY	Custom Length, Plenum			Please Call for Price

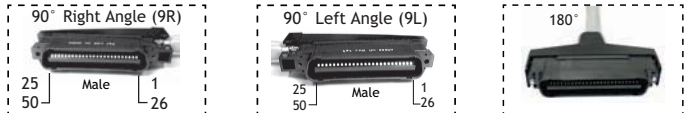

(Gender) of Telco: MM = Male-to-Male, FF = Female-to-Female, MF = Male-to-Female

X₁ AND X₂ = Connector Type; 1 = 180°, 9 = 90°

OCTOPUS CABLE

- Telco 50 pin to RJ-11 or RJ-45 plugs.
- Clear numbering on each leg.
- Cable Type: CAT5, 24 AWG, Stranded, UTP, Round.
- Custom wiring or length is available upon request.



ORDER CODE	#LEGS	ACTIVE PINS	WIRING	UNIT PRICE
035-224(M/F) X ₁ -62U-YY-XX	24	6P2C(3,4)	USOC	\$42.00 + \$3.00/ft
035-412(M/F) X ₁ -64U-YY-XX	12	6P4C(2-5)	USOC	35.00 + 1.50/ft
035-412(M/F) X ₁ -84T-YY-XX	12	8P4C(1,2,3,6)	10 Base-T	35.00 + 1.50/ft
035-608(M/F) X ₁ -66U-YY-XX	8	6P6C(1-6)	USOC	33.00 + 1.30/ft
035-806(M/F) X ₁ -88A-YY-XX	6	8P8C(1-8)	258A	31.00 + 1.00/ft
035-806(M/F) X ₁ -88E-YY-XX	6	8P8C(1-8)	568A	31.00 + 1.00/ft

(M/F) = Gender of Telco: M = Male or F = Female; X₁ = Connector Type; 1 = 180°, 9 = 90°

YY = Length of Cable in feet

XX = Color	WH	BK	PP	RD	OR	IV
	GY	BL	GN	BR	YL	PK



TELCO 50 PIN GENDER CHANGER

ORDER CODE	DESCRIPTION	1-24	25-49	50+
04G-50MM	Male to Male	\$14.08	13.44	12.48
04G-50MF	Male to Female	14.08	13.44	12.48
04G-50FF	Female to Female	14.08	13.44	12.48

BULK CABLES

25 PAIR CABLE

- PVC version, 24 AWG.
- Plenum 25 Pair Cable also available.



ORDER CODE	DESCRIPTION	UNIT PRICE
BN-1864A	24 AWG, 25 Pair Cable, PVC, CAT5	Please Call for Price
BN-1232A	24 AWG, 25 Pair Cable, PVC, CAT3	Please Call for Price

TRUE CAT5 25 PAIR TRUNK CABLE - SYSTEMAX CABLE

TRUE CATEGORY 5 - 25-PAIR TRUNK CABLE

- Systemax's 525 Telco 50 pin connector and 1061C 25-pair PVC cable, assembled by Tri-Net Technology.
- Exceeds EIA/TIA 568A CAT 5 PowerSum NEXT (PSNEXT) requirements by an average factor of 6 dB.
- Male Telco 50 pin connector with 45° (left or right angle), 90°, or 180° hoods.
- Female Telco 50 pin connector is available in 90° hoods only.
- Plenum cable assembly is also available upon request.

- Male connectors both ends, PVC cable.

ORDER CODE	DESCRIPTION	1-4	5-9	10+
04A-11-MM-10	180° to 180°, 10 ft	\$69.50	66.75	64.50
04A-19-MM-10	180° to 90°, 10 ft	69.50	66.75	64.50
04A-1(4/4 _R)-MM-10	180° to 45°, 10 ft	69.50	66.75	64.50
04A-(4/4 _R)(4/4 _R)-MM-10	45° to 45°, 10 ft	69.50	66.75	64.50
04A-(4/4 _R)-9-MM-10	45° to 90°, 10 ft	69.50	66.75	64.50
04A-99-MM-10	90° to 90°, 10 ft	69.50	66.75	64.50

Custom Length: 04A-(X,X₂)-MM-(length in feet) PVC - \$55.00 + \$1.45/ft

Custom Length: 04B-(X,X₂)-MM-(length in feet) Plenum - Please Call for Price

X₁ and X₂ = Connector Type; 1 = 180°, 4_L = 45° (left angle), 4_R = 45° (right angle), 9 = 90°

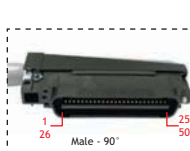
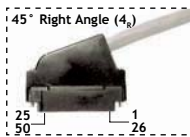

- Male connectors one end, open the other end, PVC cable.

ORDER CODE	DESCRIPTION	1-4	5-9	10+
04A-10-M-10	180° to Open, 10 ft	\$42.00	41.00	40.00
04A-(4/4 _R)0-M-10	45° to Open, 10 ft	42.00	41.00	40.00
04A-90-M-10	90° to Open, 10 ft	42.00	41.00	40.00

Custom Length: 04A-(X)0-M-(length in feet) PVC - \$27.50 + \$1.45/ft

Custom Length: 04B-(X)0-M-(length in feet) Plenum - Please Call for Price

X = Connector Type; 1 = 180°, 4_L = 45° (left angle), 4_R = 45° (right angle), 9 = 90°

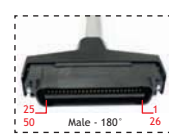

- Male connector one end, female the other end, PVC cable.

ORDER CODE	DESCRIPTION	1-4	5-9	10+
04A-19-MF-10	180° (M) to 90° (F), 10 ft	\$69.50	66.75	64.50
04A-(4/4 _R)9-MF-10	45° (M) to 90° (F), 10 ft	69.50	66.75	64.50
04A-99-MF-10	90° (M) to 90° (F), 10 ft	69.50	66.75	64.50

Custom Length: 04A-(X)9-MF-(length in feet) PVC - \$55.00 + \$1.45/ft

Custom Length: 04B-(X)9-MF-(length in feet) Plenum - Please Call for Price

X₁ = Male Connector Type; 1 = 180°, 4_L = 45° (left angle), 4_R = 45° (right angle)

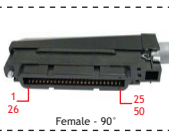

- Female connectors both ends, PVC cable.

ORDER CODE	DESCRIPTION	1-4	5-9	10+
04A-99-FF-10	90° to 90° (F), 10 ft	\$69.50	66.75	64.50

Custom Length: 04A-99-FF-(length in feet) PVC - \$55.00 + \$1.45/ft

Custom Length: 04B-99-FF-(length in feet) Plenum - Please Call for Price



CAT6 110- PUNCH DOWN TYPE IN-LINE SHIELDED COUPLER

- For extension or fan out of shielded CAT6 4-pair cable without RJ-45 connections.
- Shielded enclosure with one dedicated terminal for drain wire punch down.
- Wiring Scheme: Pin to Pin, universal for both 568A or 568B(258A) standard.
- Internal PCB (Printed Circuit Board) structure with chrome plated enclosure - meets EIA/TIA Cat6 specifications.
- Surface mountable enclosure with cable tie loops.
- Color-coded 110 punch down terminals.

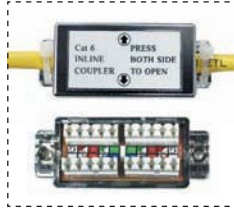

ORDER CODE	1-49	50-99	100+
080-110-4-SH-C6	\$7.39	7.06	6.55



CAT6a 90° 110 TYPE MINI KEYSTONE JACK SHIELDED

- Exceeds TIA/EIA CAT6 specification to support 10G Base-Tand Gigabyte Ethernet system application
- Hardware certification comply with TIA/EIA-568-B.2-1 CAT6
- Mountable for all kinds of standard keystone jack opening
- Wire pins are plated with 50 micro inches gold over nickle
- 110 IDC accepts 23-24 AWG wires
- Available in both T568A and T568B universal wiring
- Product is RoHS Compliant
- Shielded

ORDER CODE	DESCRIPTION	1-49	50-99	100+
07E-188-M-C6A	Cat6a 90° 110 Type Mini Keystone Jack Shielded	\$11.00	10.50	9.75

CAT5E SHIELDED KEYSTONE JACKS

- True 110-Type IDC termination with strain-relief cap.
- Two-piece snap-on type metal enclosure provides 100% shielding.
- Unique cable entry holder to fit with different cable OD.
- Metal enclosure connects to pin in the 110 connector to provide drain wire direct connection.
- 50µ" gold plating on jack contacts - meet all FCC part 68 specification.
- UL Verified Cat5E - meet EIA/TIA TSB-40A specification.



ORDER CODE	DESCRIPTION	1-49	50-99	100+
07E-188-BK	CAT5E, 8P8C RJ-45	\$3.87	3.70	3.43
07E-188-C6	CAT6 110 90° Termination Keystone Jack	5.90	5.63	5.23

CAT6a SHIELDED SNAP-IN COUPLER PANEL MOUNTABLE

- Snap-in type enclosure allows easy mounting onto any keystone jack wall plate or panel.
- Shielded
- Compact Size: 0.57" (W) x 0.64" (H) x 1.18" (D)

SHIELDED CAT6 RJ45 IN-LINE COUPLER-PANEL MOUNTABLE

- Snap-In type enclosure allows easy mounting onto any Keystone Jack wall plates or panels.
- Fully shielded enclosure meets EMI/RFI requirements.

ORDER CODE	1-49	50-99	100+
080-885-C6-SI-SH	\$6.95	6.64	6.16

CAT5E SHIELDED MINI COUPLER

- Straight-thru pin-to-pin wiring configuration.
- Superior PCB design ensures highest performance.
- Meets EIA/TIA 568A Cat5E specifications.
- Shielded enclosure meets EMI/RFI requirements.
- Snap-in type enclosure allows easy mounting onto any keystone jack wall plates or panels.

ORDER CODE	1-49	50-99	100+
080-C5E-SI-SH-M	\$4.75	4.54	4.21

SHIELDED RJ-45 IN-LINE COUPLER

- Snap-in type design.
- Full metal enclosure, shielded.
- Pin-to-pin configuration.

ORDER CODE	1-49	50-99	100+
080-885-SI-SH	\$3.08	2.94	2.73

CAT6 SHIELDED PATCH CABLES

CAT6 CERTIFIED RJ-45 SHIELDED PATCH CABLES

- 26 AWG, stranded (7 x 32) bare copper, four twisted pair with aluminum mylar foil shielded, drain wire, ETL / UL verified, meets Category 6 specifications, tested to 550 MHz.
- Modular plug: Category 6 shielded long body 3 pieces stagger type RJ-45 plug with snag-free strain relief boot.
- Snag-free strain relief boot provides the most secure and accurate connection.
- Multi-colored jackets enhance network cabling management solutions.
- Meets and exceeds EIA/TIA 568A-4 Category 6 patch cable standards.
- FLUKE DSP-4300 100% tested and certified (4-25 feet only).



ORDER CODE	LENGTH	1-49	50-99	100+
05GH-01-A-YY/XX	1 foot	\$6.48	6.18	5.74
05GH-02-A-YY/XX	2 feet	6.79	6.48	6.02
05GH-03-A-YY/XX	3 feet	7.11	6.79	6.30
05GH-05-A-YY/XX	5 feet	7.74	7.39	6.86
05GH-07-A-YY/XX	7 feet	8.38	8.00	7.43
05GH-10-A-YY/XX	10 feet	9.33	8.90	8.27
05GH-14-A-YY/XX	14 feet	10.91	10.42	9.67
05GH-20-A-YY/XX	20 feet	12.50	11.93	11.08
05GH-25-A-YY/XX	25 feet	14.08	13.44	12.48
05GH-50-A-YY/XX	50 feet	22.00	21.00	19.50
05GH-75-A-YY/XX	75 feet	29.92	28.56	26.52
05GH-100-A-YY/XX	100 feet	37.84	36.12	33.54

XX = Boot Color	YY = Cable Color
WH - White	WH - White
GY - Gray	GY - Gray
BK - Black	BK - Black
BL - Blue	BL - Blue
PP - Purple	GN - Green
GN - Green	RD - Red
RD - Red	OR - Orange
OR - Orange	YL - Yellow
YL - Yellow	PK - Pink

• Custom Length: \$6.30 + \$0.32/feet



CABLES/ACCESSORIES

SHIELDED BULK CABLE

- 1000 feet per reel.

XX = Color	Colors on page
06F-R4P-T-24-XX-SH	31
06G-R4P-T-26-XX-SH	27

ORDER CODE	DESCRIPTION	PRICE
062-F4C-T-26-(SV/BK)-SH	4 Conductors, Flat, Silver or Black	PLEASE CALL US FOR PRICING
062-F6C-T-26-(SV/BK)-SH	6 Conductors, Flat, Silver or Black	
06F-R4P-T-24-XX-SH	CAT5E Stranded, 4-Pair, Round	
06F-R4P-S-24-GY-SH	CAT5E Solid, 4-Pair, Round, Gray	
06G-R4P-S-24-GY-SH	CAT6 Shielded Twist Pair, Solid, Gray	
06G-R4P-T-26-XX-SH	CAT6 Shielded Twist Pair, Stranded	

** Additional order in special colors are available. MOQ is 10,000 feet. **

SHIELDED RJ-45 MODULAR PLUGS

- 50µ" gold plating, for solid and or stranded cables.

ORDER CODE	DESCRIPTION	1-49	50-99	100+
060-R88-T-50-SH	8P8C, RJ-45 Stranded	\$0.53	0.50	0.47
060-R88-S-50-SH	8P8C, RJ-45 Solid	0.53	0.50	0.47
060-R88-T-50-C5E-SH	8P8C, CAT5E Stranded	0.88	0.84	0.78
060-R88-T-50-C6-SH	8P8C, CAT6 Stranded	1.41	1.34	1.25



CAT5E CABLES

MOLDED TYPE (SHIELDED) RJ-45 WITH SNAG FREE BOOT

- Molded strain relief with snag free cap from the cable entry to the end of plug.
- Cable: ETL/UL verified Cat5E, 24 AWG, stranded (7x32) bare copper, 4 twisted pairs with aluminum mylar foil shielded, drain wire.
- Staggered type Cat5E RJ-45 plug reduces NEXT.

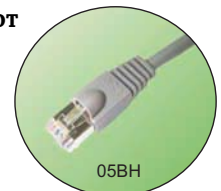

ORDER CODE	LENGTH	1-49	50-99	100+
05BH-01-A-YY/XX	1 foot	\$4.66	4.45	4.13
05BH-02-A-YY/XX	2 feet	4.93	4.70	4.37
05BH-03-A-YY/XX	3 feet	5.19	4.96	4.60
05BH-05-A-YY/XX	5 feet	5.72	5.46	5.07
05BH-07-A-YY/XX	7 feet	6.25	5.96	5.54
05BH-10-A-YY/XX	10 feet	7.04	6.72	6.24
05BH-15-A-YY/XX	15 feet	8.36	7.98	7.41
05BH-20-A-YY/XX	20 feet	9.68	9.24	8.58
05BH-25-A-YY/XX	25 feet	11.00	10.50	9.75
05BH-50-A-YY/XX	50 feet	17.60	16.80	15.60
05BH-75-A-YY/XX	75 feet	24.20	23.10	21.45
05BH-100-A-YY/XX	100 feet	30.80	29.40	27.30

• Custom Length: \$5.00 + 0.30/ft

XX = Injection Mold Color	WH	BK	PP	RD	OR	IV
	GY	BL	GN	BR	YL	PK

YY = Cable Color	GY	BK	BL	GN	RD	OR	YL
------------------	----	----	----	----	----	----	----

Custom Wiring and Length Available



66 TERMINAL BLOCK

- Modular insulated blocks secures two or more wires together.
- Its flexibility allows wiring to be centralized and makes it easier to maintain complex control circuits.

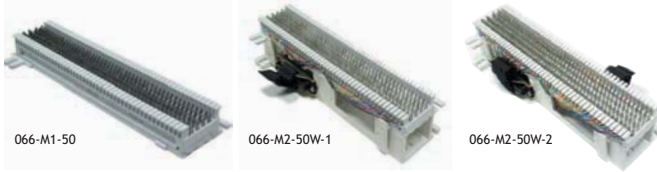

ORDER CODE	# PAIR	# TELCO	GENDER OF TELCO	1-9	10-19	20+
066-M1-50	25	None	None	\$12.32	11.76	10.92
066-M2-50W-1	25	1	Female	52.27	49.90	46.33
066-M2-50W-2	25	2	Female	67.14	64.09	59.51

MODULAR PATCH PANEL - TELCO TYPE, HIGH DENSITY, CATEGORY 4

- Compact, low profile:
24 Port: 1 rack space (1.75" H),
48 Port: 2 rack space (3.5" H),
96 Port: 4 rack space (7" H),
- Equipped with Male Telco50 pin.



ORDER CODE	# PORTS	ACTIVE PINS	WIRING	1-4	5-9	10+
017-224-M62-U	24 RJ-11	6P2C (3 - 4)	USOC	\$88.00	84.00	78.00
017-248-M62-U	48 RJ-11	6P2C (3 - 4)	USOC	124.96	119.28	110.76
017-424-M64-U	24 RJ-11	6P4C (2 - 5)	USOC	105.60	100.80	93.60
017-448-M64-U	48 RJ-11	6P4C (2 - 5)	USOC	140.80	134.40	124.80
017-424-M84-T	24 RJ-45	8P4C (1, 2, 3, 6)	10Base-T	105.60	100.80	93.60
017-448-M84-T	48 RJ-45	8P4C (1, 2, 3, 6)	10Base-T	140.80	134.40	124.80
017-624-M66-U	24 RJ-12	6P6C (1 - 6)	USOC	114.40	109.20	101.40
017-648-M66-U	48 RJ-12	6P6C (1 - 6)	USOC	172.48	164.64	152.88
017-824-M88-258A	24 RJ-45	8P8C (1 - 8)	258A	137.28	131.04	121.68
017-848-M88-258A	48 RJ-45	8P8C (1 - 8)	258A	193.60	184.80	171.60
017-824-M88-568A	24 RJ-45	8P8C (1 - 8)	568A	137.28	131.04	121.68
017-848-M88-568A	48 RJ-45	8P8C (1 - 8)	568A	193.60	184.80	171.60

** Female Telco available on request **

**1U (1 3/4") & 2U (3 1/2") HIGH DENSITY
16 / 24 / 48-PORT FEED-THRU PANEL**

- 19" wide black color, 1/8" thick steel panel.
- Clear white silk screen number on the panel.
- Mini couplers can be loaded: RJ-12, RJ-45, Cat5E, Cat6.

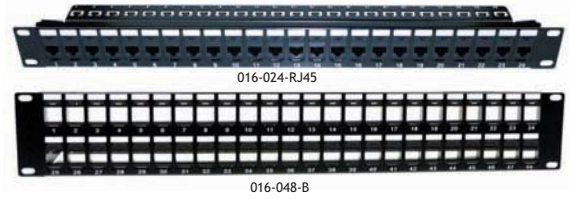

ORDER CODE	DESCRIPTION	1-4	5-9	10+
016-016-B	1U 16-Port Blank Panel (Flush Type)	\$30.80	29.40	27.30
016-024-B	1U 24-Port Blank Panel (Flush Type)	35.20	33.60	31.20
016-048-B	2U 48-Port Blank Panel (Flush Type)	49.28	47.04	43.68
016-016-RJ12	1U 16-Port RJ-12 Feed Thru Panel	66.88	63.84	59.28
016-024-RJ12	1U 24-Port RJ-12 Feed Thru Panel	96.80	92.40	85.80
016-048-RJ12	2U 48-Port RJ-12 Feed Thru Panel	172.48	164.64	152.88
016-016-RJ45	1U 16-Port RJ-45 Feed Thru Panel	88.00	84.00	78.00
016-024-RJ45	1U 24-Port RJ-45 Feed Thru Panel	105.60	100.80	93.60
016-048-RJ45	2U 48-Port RJ-45 Feed Thru Panel	184.50	175.25	163.78
016-016-C5E	1U 16-Port CAT5E RJ-45 Feed Thru Panel	105.60	100.80	93.60
016-024-C5E	1U 24-Port CAT5E RJ-45 Feed Thru Panel	174.24	166.32	154.44
016-048-C5E	2U 48-Port CAT5E RJ-45 Feed Thru Panel	308.00	294.00	273.00
016-016-C6	1U 16-Port CAT6 RJ-45 Feed Thru Panel	137.28	131.04	121.68
016-024-C6	1U 24-Port CAT6 RJ-45 Feed Thru Panel	211.20	201.60	187.20
016-048-C6	2U 48-Port CAT6 RJ-45 Feed Thru Panel	401.28	383.04	355.68
016-016-C6A	1U 16-Port CAT6A RJ-45 Feed Thru Panel	147.84	141.12	131.04
016-024-C6A	1U 24-Port CAT6A RJ-45 Feed Thru Panel	225.28	215.04	199.68
016-048-C6A	2U 48-Port CAT6A RJ-45 Feed Thru Panel	425.92	406.56	377.52

19" BLANK PANEL FOR KEYSTONE JACKS & FEED-THRU JACKS

- Black color, 1/16" thickness.
- Cutout dimension meets virtually all snap-in jacks.
- Numbering on panel.

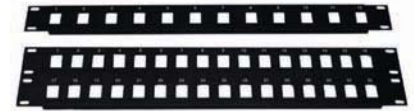

ORDER CODE	# CUTOUPS	HEIGHT	# RACK SPACE	1-4	5-9	10+
014-012-B	12	1.75"	1	\$24.99	23.86	22.15
014-016-B	16	1.75"	1	26.31	25.12	23.32
014-024-B	24	3.50"	2	35.20	33.60	31.20
014-032-B	32	3.50"	2	39.42	37.63	34.94
014-048-B	48	5.25"	3	44.53	42.50	39.47

MODULAR IN-LINE COUPLERS

- For joining of 2 cables with both RJ-11, RJ-12, or RJ-45 connectors.
- Patented Printed Circuit Board design ensures CAT5E (080-RJ45-C5) or CAT6 (080-RJ45-C6) performance.



ORDER CODE	DESCRIPTION	1-49	50-99	100+
080-64S	6P4C, RJ-11, Pin-to-Pin	\$0.79	0.76	0.70
080-64R	6P4C, RJ-11, Reverse	0.79	0.76	0.70
080-66S	6P6C, RJ-12, Pin-to-Pin	0.79	0.76	0.70
080-66R	6P6C, RJ-12, Reverse	0.79	0.76	0.70
080-88S	8P8C, RJ-45, Pin-to-Pin	0.79	0.76	0.70
080-88R	8P8C, RJ-45, Reverse	0.79	0.76	0.70
080-RJ45-C5	RJ-45 CAT5E In-Line Coupler	3.87	3.70	3.43
080-RJ45-C6	RJ-45 CAT6 In-Line Coupler	5.72	5.46	5.07

10 BASE-T CROSS OVER ADAPTER

- Pin 1, 2 / 3, 6 crossover.
- Ideal for Hub to Hub cascades or station to station connections.

ORDER CODE	1-49	50-99	100+
080-10T-CROSS	\$2.11	2.02	1.87



100 BASE-TX CROSS OVER ADAPTER

- Pin 1, 2 / 3, 6 crossover. Ideal for Hub to Hub cascades or station to station connections.
- Printed Circuit Board design ensures CAT5E or CAT6 performance.

ORDER CODE	1-49	50-99	100+
080-88-CR-C5	\$3.87	3.70	3.43
080-88-CR-C6	6.42	6.13	5.69

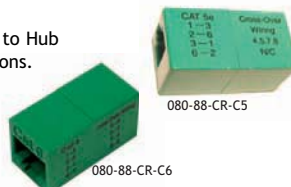

ADAPTERS

MODULAR PLUG TO JACK ADAPTERS

- Design to convert different wiring scheme easily.
- Used as connector saver to extend expensive modular jack equipment.
- RJ-11 and RJ-45 Jack to Plug interchangeable.
- Custom wiring adapters are available upon request.
- Plug: RJ-45 8P8C, RJ-12 6P6C, 50µ" gold plating.
- Jack: RJ-45 8P8C, RJ-12 6P6C, 50µ" gold plating.
- Dimension: 0.88" (H) x 0.65" (W) x 2.08" (L).



ORDER CODE	DESCRIPTION	WIRING SCHEME	1-49	50-99	100+
A) 086-RJ45/RJ45-S	RJ-45 plug to RJ-45 jack	Straight Through (A)	\$7.04	6.72	6.24
B) 086-RJ45/RJ45-X	RJ-45 plug to RJ-45 jack	10BaseT X-Over (B)	7.04	6.72	6.24
C) 086-RJ45/RJ12-S	RJ-45 plug to RJ-12 jack	Straight Through (C)	7.04	6.72	6.24
D) 086-RJ12/RJ45-S	RJ-12 plug to RJ-45 jack	Straight Through (D)	7.04	6.72	6.24

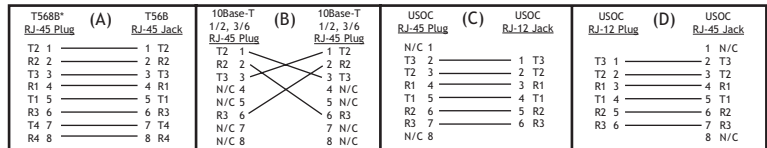

T-ADAPTER

- Parallel wiring.
- Custom wiring configurations available upon request, please call for price.

ORDER CODE	JACK TYPE	1-49	50-99	100+
081-444	6P4C	\$0.88	0.84	0.78
081-666	6P6C	0.88	0.84	0.78
081-888	8P8C	0.88	0.84	0.78

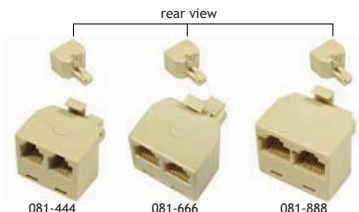

NETWORK CABLE TESTER

- Tests for RJ-45 modular connection with 258A, 568A and B, 356A wiring and 10Base-T, RJ-12 and RJ-11 USOC wiring and coaxial cables with BNC connectors.
- Performs tests of cable continuity, miss-wiring and polarization by the color of large-sized LEDs.
- Kit includes one master and one remote unit, one BNC adapter, two BNC/F adapters, and a carry case.
- Detachable remote unit for installed cabling.
- Additional Remote Module Unit is available.

ORDER CODE	1-9	10-19	20+
069-TNT-N	\$28.16	26.88	24.96



MODULAR PLUG CRIMPING TOOL WITH RATCHET

- Works with RJ-11/6P4C, RJ-12/6P6C, and RJ-45/8P8C modular plugs.
- Cuts and strips cable outer jacket, and crimps modular plug in one unit.
- Ratchet design delivers precise, exact crimp.
- Heavy gauge metal frame, sturdy structure.

ORDER CODE	1-9	10-19	20+
061-M-3IN1-R	\$31.68	30.24	28.08



ROUND & FLAT CABLE STRIPPING TOOL

- Strips and cuts 2, 4, 6, 8, and 10 conductor cables.
- Adjustable screw to fit insulation of different outside diameter, avoiding damage of the inner conductors.

ORDER CODE	1-9	10-19	20+
061-501	\$9.68	9.24	8.58



IMPACT PUNCH DOWN TOOL AND REPLACEMENT BLADE

- Easy grip handle.
- Includes 110 or 66 insert and cut blade.
- Easy to use spring loaded design.
- Interchangeable blades.
- Storage compartment for additional blade.

ORDER CODE	DESCRIPTION	1-9	10-19	20+
061-110P	Impact Tool with 110 Blade	\$31.68	30.24	28.08
061-66P	Impact Tool with 66 Blade	35.20	33.60	31.20
061-601A	Blade for 66 Terminal	10.56	10.08	9.36
061-601B	Blade for 110 Terminal	10.56	10.08	9.36



ORDER CODE	TERMINAL TYPE	BODY	BLADE
061-66P	66	X	X
061-110P	110	X	X
061-601A	66		X
061-601B	110		X

MODULAR LINE CORD ASSEMBLY

- 26 AWG, stranded, flat, silver satin, UL Listed cable.

ORDER CODE	PLUG	# CONDUCTORS	LENGTH	1-49	50-99	100+
050-464-(S/R)-07-SV	6P4C	4	7	\$0.88	0.84	0.78
050-464-(S/R)-14-SV	6P4C	4	14	1.37	1.31	1.22
050-464-(S/R)-25-SV	6P4C	4	25	2.11	2.02	1.87
050-464-(S/R)-50-SV	6P4C	4	50	6.69	6.38	5.93
050-464-(S/R)-100-SV	6P4C	4	100	11.97	11.42	10.61
050-464-(S/R)-150-SV	6P4C	4	150	17.25	16.46	15.29
050-666-(S/R)-07-SV	6P6C	6	7	1.23	1.18	1.09
050-666-(S/R)-14-SV	6P6C	6	14	1.97	1.88	1.75
050-666-(S/R)-25-SV	6P6C	6	25	3.17	3.02	2.81
050-666-(S/R)-50-SV	6P6C	6	50	7.57	7.22	6.71
050-666-(S/R)-100-SV	6P6C	6	100	13.73	13.10	12.17
050-666-(S/R)-150-SV	6P6C	6	150	19.89	18.98	17.63
050-888-(S/R)-07-SV	8P8C	8	7	2.75	2.62	2.43
050-888-(S/R)-14-SV	8P8C	8	14	3.73	3.56	3.31
050-888-(S/R)-25-SV	8P8C	8	25	5.28	5.04	4.68
050-888-(S/R)-50-SV	8P8C	8	50	8.80	8.40	7.80
050-888-(S/R)-100-SV	8P8C	8	100	15.84	15.12	14.04
050-888-(S/R)-150-SV	8P8C	8	150	22.88	21.84	20.28
050-605-R-07-SV	DEC offset	6	7	2.62	2.50	2.32
050-605-R-14-SV	DEC offset	6	14	3.48	3.33	3.09
050-605-R-25-SV	DEC offset	6	25	4.84	4.62	4.29



(S/R): (Please select one), S = Pin-to-Pin or R = Reverse

BULK CABLES

BULK CABLE - TELEPHONE FLAT CABLE

- 26 AWG, Stranded (7 x 31), bare copper in 4, 6, 8, 10 conductors.
- UL-listed: #E132667 20251, 1000 feet/reel.



ORDER CODE	DESCRIPTION	PRICE
062-F4C-T-26-SV-UL	4 Conductors, Silver Satin	
062-F4C-T-26-BK-UL	4 Conductors, Black	
062-F6C-T-26-SV-UL	6 Conductors, Silver Satin	
062-F6C-T-26-BK-UL	6 Conductors, Black	
062-F8C-T-26-SV-UL	8 Conductors, Silver Satin	
062-F8C-T-26-BK-UL	8 Conductors, Black	
062-F10C-T-26-SV-UL	10 Conductors, Silver Satin	
062-F10C-T-26-BK-UL	10 Conductors, Black	

PLEASE CALL FOR PRICE

CAT5 & CAT5E, STRANDED UTP BULK CABLE

- 24 AWG, Stranded bare Copper.
- 1000 feet/box.



ORDER CODE	DESCRIPTION	PRICE
06F-R2P-T-24-(GY/BK)	Cat5E, 2-Pair, Gray or Black	Please Call for Price
06F-R4P-T-24-YY	Cat5E, 350Mhz, 4-Pair	Please Call for Price

YY = Color	WH = White	BK = Black	PP = Purple	RD = Red	OR = Orange
	GY = Gray	BL = Blue	GN = Green	PK = Pink	YL = Yellow

PLUGS

MODULAR PLUG

- For Stranded or Solid wire assemblies, UL and CSA listed.



ORDER CODE	ENTRY SIZE	POSITION CONTACT	JACKET TYPE	1-499	500-999	1000+
060-F44-T-6	Flat	4P4C/(handset)	Stranded	\$0.11	0.10	0.09
060-F64-T-6	Flat	6P4C/RJ-11	Stranded	0.11	0.10	0.09
060-F66-T-6	Flat	6P6C/RJ-12	Stranded	0.12	0.12	0.11
060-F05-T-6	Flat	6P6C/DEC/Offset	Stranded	0.25	0.24	0.22
060-F88-T-6	Flat	8P8C/RJ-45	Stranded	0.14	0.13	0.12
060-R10-T-6	Flat	10P10C	Stranded	0.44	0.42	0.39
060-R64-T-6	Round	6P4C/RJ-11	Stranded	0.11	0.10	0.09
060-R66-T-6	Round	6P6C/RJ-12	Stranded	0.11	0.10	0.09
060-R88-T-6	Round	8P8C/RJ-45	Stranded	0.14	0.13	0.12
060-R64-S-6	Round	6P4C/RJ-11	Solid	0.16	0.15	0.14
060-R66-S-6	Round	6P6C/RJ-12	Solid	0.16	0.15	0.14
060-F05-S-6	Flat	6P6C/DEC/Offset	Solid	0.35	0.34	0.31
060-R88-S-6	Round	8P8C/RJ-45	Solid	0.18	0.17	0.16
060-R10-S-6	Round	10P10C	Solid	0.62	0.59	0.55
060-R88-T-50-C5E	Round	8P8C/Cat5E	Stranded	0.32	0.30	0.28
060-R88-T-50-C6	Round	8P8C/Cat6	Stranded	0.44	0.42	0.39

SNAG FREE CAPS & BOOTS

SNAG FREE MULTI-COLOR CAP/BOOT FOR RJ45 PLUG

- Works as secondary strain-relief for double security.
- Multi-color body for clear identification of different protocols.
- Keep plug latch from catching onto other cords when removing from densely populated patch panels.
- Applied before termination of RJ45 plugs : 060-BOOT-8-XX.
- Applied after termination of RJ-45 plugs : 060-MPSR-8-YY; 060-BOOT-SR3-ZZ.



060-BOOT-8-XX



060-MPSR-8-YY

ORDER CODE	1-499	500-999	1000+
060-BOOT-8-XX	\$0.18	0.17	0.16
060-BOOT-SR3-ZZ	0.35	0.34	0.31
060-MPSR-8-YY	3.17	3.02	2.81

YY = Color	ZZ = Color	XX = Color
WH = White	WH = White	WH = White
GY = Gray	GY = Gray	GY = Gray
BK = Black	BK = Black	BK = Black
BL = Blue	BL = Blue	BL = Blue
PP = Purple	PP = Purple	PP = Purple
GN = Green	GN = Green	GN = Green
RD = Red	RD = Red	RD = Red
OR = Orange	OR = Orange	OR = Orange
YL = Yellow	YL = Yellow	YL = Yellow
IV = Ivory	IV = Ivory	IV = Ivory
	PK = Pink	PK = Pink

060-BOOT-SR3-ZZ

MODULAR ADAPTERS

D-SUB 9/15/25 TO RJ-12/45/MMJ MODULAR ADAPTER KIT

- One-piece hood with long thumbscrews.
- Kit form type. Assembly required per application wiring spec.
- In-house assembly available upon request; please provide wiring configuration for price quote.



XX = Color
GY = Gray
BK = Black
BL = Blue
GN = Green
RD = Red
YL = Yellow



ORDER CODE	DESCRIPTION	1-49	50-99	100+
500-D09-6F-XX	DB-9 Female to RJ-12, 6 Wire	\$1.50	1.43	1.33
500-D09-6M-XX	DB-9 Male to RJ-12, 6 Wire	1.50	1.43	1.33
500-D09-8FK-XX	DB-9 Female to RJ-45, 8 Wire	1.50	1.43	1.33
500-D09-8MK-XX	DB-9 Male to RJ-45, 8 Wire	1.50	1.43	1.33
500-D15-6F-BK	DB-15 Female to RJ-12, 6 Wire	1.50	1.43	1.33
500-D15-6M-BK	DB-15 Male to RJ-12, 6 Wire	1.50	1.43	1.33
500-D15-8FK-BK	DB-15 Female to RJ-45, 8 Wire	1.50	1.43	1.33
500-D15-8MK-BK	DB-15 Male to RJ-45, 8 Wire	1.50	1.43	1.33
500-D25-6F-XX	DB-25 Female to RJ-12, 6 Wire	1.50	1.43	1.33
500-D25-6M-XX	DB-25 Male to RJ-12, 6 Wire	1.50	1.43	1.33
500-D25-8FK-XX	DB-25 Female to RJ-45, 8 Wire	1.50	1.43	1.33
500-D25-8MK-XX	DB-25 Male to RJ-45, 8 Wire	1.50	1.43	1.33
500-D09-OSF-BK	DB-9 Female to MMJ Offset, Black	1.76	1.68	1.56
500-D09-OSM-BK	DB-9 Male to MMJ Offset, Black	1.76	1.68	1.56
500-D25-OSF-BK	DB-25 Female to MMJ Offset, Black	1.76	1.68	1.56
500-D25-OSM-BK	DB-25 Male to MMJ Offset, Black	1.76	1.68	1.56

D-SUB JUMPER WIRE

- Optional for above modular adapter.

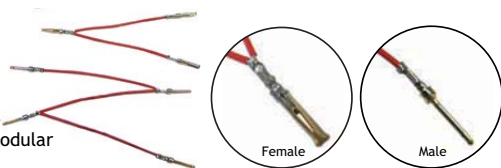

ORDER CODE	DESCRIPTION	1-99	100-199	200+
505-2M	Male/Male	\$0.26	0.25	0.23
505-2F	Female/Female	0.26	0.25	0.23
505-3M	Male/Male/Male	0.44	0.42	0.39
505-3F	Female/Female/Female	0.44	0.42	0.39
505-4M	Male/Male/Male/Male	0.62	0.59	0.55
505-4F	Female/Female/Female/Female	0.62	0.59	0.55

TOOLS

INSERTION-EXTRACTION TOOL

ORDER CODE	1-9	10-19	20+
521-TOOL	\$1.87	1.78	1.65



CRIMPING TOOL

- Ratchet Crimping Tool.
- For crimping 10-22 AWG, non-insulated open barrel connectors, D-Sub and V.35 connectors.



ORDER CODE	1-9	10-19	20+
061-301U	\$31.68	30.24	28.08

FEED-THRU PANELS

D-SUB FEED THRU PANEL

- Black, metal panel with numbering.
- Loaded with low-profile gender changer.



ORDER CODE	# PORTS	1-4	5-9	10+
504-(9/15/25)-(Gender)-16	16	\$103.84	99.12	92.04
504-(9/15/25)-(Gender)-32	32	184.80	176.40	163.80
504-(9/15/25)-(Gender)-48	48	272.80	260.40	241.80

(9/15/25) = Type of DB Connector;
9 = DB-9, 15 = DB-15, 25 = DB-25

(Gender) = Gender of D-Sub Gender Changer;
FF = Female-to-Female, MF = Male-to-Female, MM = Male-to-Male

D-SUB CONNECTOR HOODS

METALIZED PLASTIC HOOD



ORDER CODE	DESCRIPTION	1-49	50-99	100+
512-09	9-Pin Hood	\$0.49	0.47	0.44
512-15	15-Pin Hood	0.56	0.54	0.50
512-25	25-Pin Hood	0.60	0.57	0.53
512-37	37-Pin Hood	0.97	0.92	0.86

METAL HOOD

ORDER CODE	DESCRIPTION	1-49	50-99	100+
102-09-M	9-Pin Hood	\$1.09	1.04	0.97
102-15-M	15-Pin Hood	1.27	1.21	1.12
102-25-M	25-Pin Hood	1.94	1.85	1.72
102-37-M	37-Pin Hood	4.84	4.62	4.29
102-50-M	50-Pin Hood	5.09	4.86	4.51



CONNECTORS

D-SUB CRIMP CONNECTOR

- Shell only; pins or sockets need to be ordered separately.

ORDER CODE	DESCRIPTION	1-49	50-99	100+
103-09-F	9-Pin Female	\$0.35	0.34	0.31
103-09-M	9-Pin Male	0.35	0.34	0.31
103-15-F	15-Pin Female	0.44	0.42	0.39
103-15-M	15-Pin Male	0.44	0.42	0.39
103-25-F	25-Pin Female	0.53	0.50	0.47
103-25-M	25-Pin Male	0.53	0.50	0.47
103-37-F	37-Pin Female	1.76	1.68	1.56
103-37-M	37-Pin Male	1.76	1.68	1.56
103-50-F	50-Pin Female	3.52	3.36	3.12
103-50-M	50-Pin Male	3.52	3.36	3.12

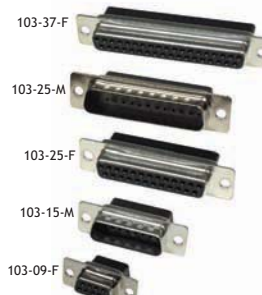

PIN AND SOCKET FOR CRIMP CONNECTORS

ORDER CODE	DESCRIPTION	1-499	500+
502-M	Male Pin	\$0.07	0.06
502-F	Female Socket	0.07	0.06

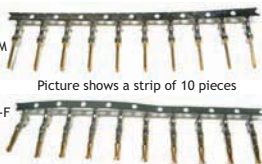

D-SUB SOLDER CONNECTOR

ORDER CODE	DESCRIPTION	1-49	50-99	100+
513-09-F	9-Pin Female	\$0.28	0.27	0.25
513-09-M	9-Pin Male	0.28	0.27	0.25
513-15-F	15-Pin Female	0.35	0.34	0.31
513-15-M	15-Pin Male	0.35	0.34	0.31
513-25-F	25-Pin Female	0.44	0.42	0.39
513-25-M	25-Pin Male	0.44	0.42	0.39
513-37-F	37-Pin Female	1.76	1.68	1.56
513-37-M	37-Pin Male	1.76	1.68	1.56
513-50-F	50-Pin Female	3.52	3.36	3.12
513-50-M	50-Pin Male	3.52	3.36	3.12

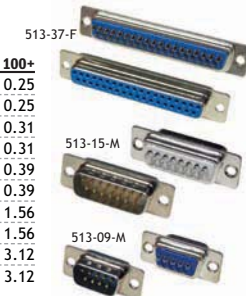

RS-232 CUSTOM CABLE MOLDED TYPE

ORDER CODE	DESCRIPTION	UNIT PRICE
522-09F-09F-XX	DB-9 Female to DB-9 Female, 9C	
522-09F-09M-XX	DB-9 Female to DB-9 Male, 9C	
522-09M-09M-XX	DB-9 Male to DB-9 Male, 9C	
522-15F-15F-XX	DB-15 Female to DB-15 Female, 15C	
522-15F-15M-XX	DB-15 Female to DB-15 Male, 15C	
522-15M-15M-XX	DB-15 Male to DB-15 Male, 15C	
522-25F-25F-XX	DB-25 Female to DB-25 Female, 25C	
522-25F-25M-XX	DB-25 Female to DB-25 Male, 25C	
522-25M-25M-XX	DB-25 Male to DB-25 Male, 25C	
522-37F-37F-XX	DB-37 Female to DB-37 Female, 37C	
522-37F-37M-XX	DB-37 Female to DB-37 Male, 37C	
522-37M-37M-XX	DB-37 Male to DB-37 Male, 37C	

PLEASE CALL FOR PRICE



19" WIDE RACK MOUNT WIRE MINDER

- Plastic wire saddle type directs patch cables to more routes.
- Metal D-Ring type holds more patch cables in a ring.

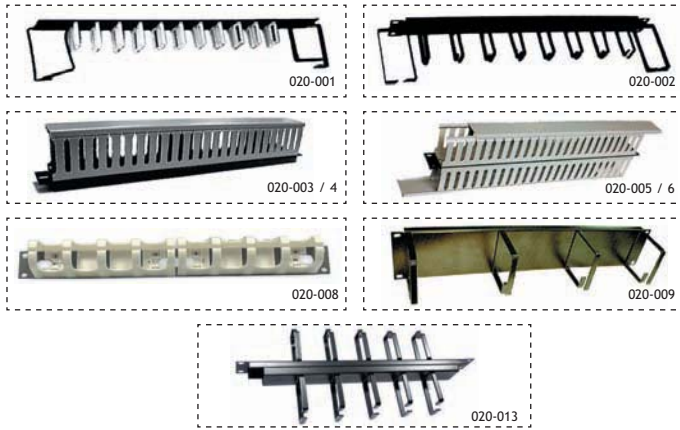

ORDER CODE	DESCRIPTION	1-9	10-19	20+
020-001	1.75"(H) Plastic Wire Saddle Type	\$24.02	22.93	21.29
020-002	1.75"(H) Metal D-Ring Type	30.89	29.48	27.38
020-003	1.75"(H) Panel with 1.75"(D) Front Wiring Duct	38.90	37.13	34.48
020-004	1.75"(H) Panel with 2.63"(D) Front Wiring Duct	45.76	43.68	40.56
020-005	1.75"(H) 2.63"(D) Front and Back Wiring Duct	73.22	69.89	64.90
020-006	1.75"(H) 1.75"(D) Front and Back Wiring Duct	68.64	65.52	60.84
020-008	1.75"(H) Patch Cord Trough	41.18	39.31	36.50
020-009	3.50"(H) Horizontal 4-Ring Type	40.48	38.64	35.88
020-013	1.75"(H) Front and Back 3"(D) Metal D-Ring	65.21	62.24	57.80

D-RING VERTICAL CABLE ORGANIZER

- Designed to maintain a neat cable flow vertically on the back or the front of a relay rack.
- Heavy gauge steel construction.
- Double-sided tape included.
- Fit within the dimensions of the rack.

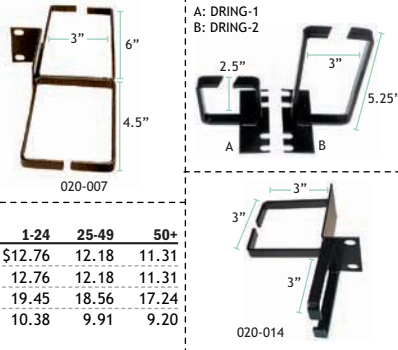

ORDER CODE	DESCRIPTION	1-24	25-49	50+
020-DRING-1	2.50" High (1U)	\$12.76	12.18	11.31
020-DRING-2	5.25" High (2U)	12.76	12.18	11.31
020-007	Vertical Dual Ring (1U)	19.45	18.56	17.24
020-014	Rack Side mount D-Ring Bracket (1U)	10.38	9.91	9.20

WALL MOUNT BRACKETS

4" DEEP HINGED WALL MOUNT BRACKET

- Swing arms - easy to access mounted panel for maintenance and installation.
- Mounting holes with nuts, meets EIA standard.
- 19" wide, 4" deep.

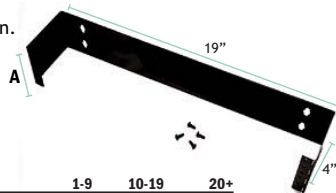

ORDER CODE	(A) HEIGHT	RACK SPACE	1-9	10-19	20+
021-001	1.75"	1	\$24.02	22.93	21.29
021-002	3.50"	2	28.16	26.88	24.96
021-003	5.25"	3	37.49	35.78	33.23
021-004	7"	4	41.71	39.82	36.97
021-005	8.75"	5	52.54	50.15	46.57
021-007	12.25"	7	68.64	65.52	60.84

DEEP WALL MOUNT BRACKET

- Designed for Hubs, switches and other deep rack mount equipments; 19" wide, 8" or 12" deep.

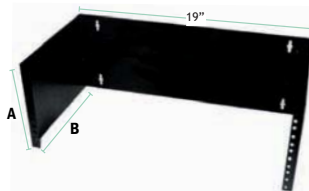

ORDER CODE	(A) HEIGHT	(B) DEPTH	1-9	10-19	20+
021-004-12	7"	12"	\$49.37	47.12	43.76
021-007-12	12.25"	12"	87.91	83.92	77.92
021-002-8	3.50"	8"	30.89	29.48	27.38

19" STEEL RELAY RACK

- #12-24 Panel mounting holes.
- Self-supporting base: 3.5" x 6" extruding angle.
- Height: 84" (7 ft).
- Weight: 52 lbs.

022-07-GY-STL



ORDER CODE	DESCRIPTION	1-9	10-19	20+
022-07-GY-STL	19" Relay Rack, Gray	\$193.60	184.80	171.60
022-07-BK-STL	19" Relay Rack, Black	193.60	184.80	171.60

19" BLANK PANELS

- 19" wide, black.

ORDER CODE	HEIGHT	# RACK SPACE	1-24	25-49	50+
026-01	1.75"	1	\$11.26	10.75	9.98
026-02	3.50"	2	13.90	13.27	12.32



EQUIPMENT SHELVES

19" VENTED SHELVES

- Slotted flange for horizontal cable management.

ORDER CODE	DIMENSION	1-9	10-19	20+
023-VC3	Center Mount, 3.50"H x 17.13"W x 19"D	\$66.35	63.34	58.81
023-VM3	Front Mount, 5.25"H x 17.63"W x 19"D	69.78	66.61	61.85

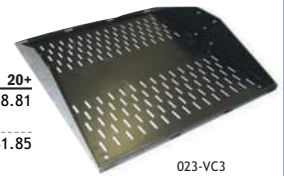

LOW COST FRONT MOUNT SHELVES

- Front and rear flange, black hard-powder coat finish.

ORDER CODE	DIMENSION	1-9	10-19	20+
023-LC1	1.75"H x 17.3"W x 10.75"D	\$27.46	26.21	24.34
023-LC2	3.47"H x 17.3"W x 14.00"D	30.89	29.48	27.38



CENTER-WEIGHT SHELVES

- Help balance heavy load, 19" deep.
- Set of rear rail mounting brackets to increase load weight capacity.

ORDER CODE	DESCRIPTION	1-9	10-19	20+
023-CP	3.50"H x 17.50"W, Vented	\$86.94	82.99	77.06
023-CS	3.50"H x 17.50"W, Solid	76.65	73.16	67.94



ADJUSTABLE CENTER - WEIGHT SHELVES,

3.50" HEIGHT

- Multi-position shelves allow you to adjust the center of your shelf farther forward for keyboards or farther back for other equipment.
- Available in solid or vented for better air flow.

ORDER CODE	DESCRIPTION	1-9	10-19	20+
023-ADS	3.50"H x 17.13"W x 19"D, Solid	\$56.06	53.51	49.69
023-ADV	3.50"H x 17.13"W x 19"D, Vented	63.45	60.56	56.24



19" RACK MOUNT TRAY - FRONT MOUNT

- Heavy 16 gauge steel formed construction, powder coated black finish.
- Front and rear flange - prevent equipment slide out of shelf.

ORDER CODE	DIMENSION	1-9	10-19	20+
023-111	1.75"H x 11"D	\$38.90	37.13	34.48
023-212	3.50"H x 12"D	46.90	44.77	41.57
023-314	5.25"H x 14"D	53.77	51.32	47.66
023-414	7.00"H x 14"D	59.49	56.78	52.73



UNIVERSAL EQUIPMENT SHELF

- Designed to be mounted on 19" relay racks with EIA spacing.
- The brackets are adjustable for various mounting configurations - flush forward, rear, and centered.
- Accommodates up to 50lb of load.
- 17" wide between brackets; 12" deep.

ORDER CODE	DIMENSION	1-9	10-19	20+
023-UES-12	1.75"H x 12"D	\$57.20	54.60	50.70



MODULAR PLUG TOOLS

OFFSET DEC TYPE MODULAR CRIMPER

- Heavy-duty all-metal construction.
- Cuts, strips, and crimps all-in-one tool.
- Offset die for DEC type modified modular plug.

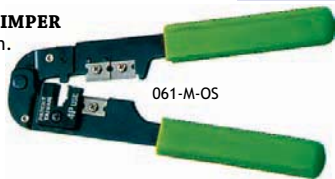

061-M-05

MODULAR PLUG CRIMPING

TOOL WITH RATCHET

- Works with RJ-11/6P4C, RJ-12/6P6C, and RJ-45/8P8C modular plugs.
- Cuts and strips cable outer jacket, and crimps modular plug in one unit.
- Ratchet design delivers precise, exact crimp.
- Heavy gauge metal frame, sturdy structure.



061-M-3IN1-R

061-200R

10P10C, AMP 8P8C/RJ-45, 6P6C/RJ-12, 6P4C and 6P2C/RJ-11, 4P4C, 4P2C hand set plug, 6P6C DEC/offset modified modular plug (MMP).

061-2008R

Regular 8P8C/RJ-45, 6P6C/RJ-12, 6P4C and 6P2C/RJ-11, 4P4C, 4P2C hand set plug, 6P6C DEC/offset MMP.

ECONOMIC TYPE RJ-45 MODULAR CRIMPER

- Metal frame with rubber grip.
- Built-in safety guide and closed lock for storage.
- Crimps RJ-45, 8 position modular plug only.
- 3 ways - cuts, strips and crimps solid or stranded cable in one unit.

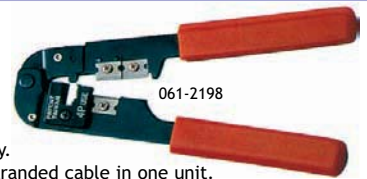

061-2198

DUAL MODULAR PLUG CRIMPER WITH RATCHET

- Straight motion and professional type provide precise operation.
- Built-in ratchet, cutter and stripper.
- For both stranded and solid wires.
- Modular die set are made of Al-Zn alloy, light weight and durable.
- For crimping 8P8C/RJ-45, 6P6C/RJ-12, and 6P4C/RJ-11 connectors.
- Length: 7.6"



061-500R

PROFESSIONAL RATCHET TYPE MODULAR CRIMPER

- Straight motion and precise crimping.
- Cuts, strips and crimps all kinds of modular plugs without changing die set.
- Metal Frame - rigid and durable.
- Built-in cutter on the rear side and stripper on the front side.



061-200R

061-2008R

ORDER CODE	HANDSET 4P4C	RJ-11 6P4C	RJ-12 6P6C	RJ-45 8P8C	RJ-45 10P10C	OFFSET 6P6C	AMP RJ-45	CUT	STRIP	RATCHET	1-9	10-19	20+
061-M-3IN1-R		X	X	X				X	X	X	\$31.68	30.24	28.08
061-M-05						X		X	X		26.40	25.20	23.40
061-2198				X				X	X		15.84	15.12	14.04
061-500R		X	X				X	X	X	X	72.16	68.88	63.96
061-200R	X	X	X		X	X	X	X	X	X	114.40	109.20	101.40
061-2008R	X	X	X	X		X		X	X	X	114.40	109.20	101.40

REMOVAL TOOLS

BNC CONNECTOR REMOVAL TOOL

- For easy insertion and removal of coaxial BNC Connectors on high density patch panels.



ORDER CODE	1-9	10-19	20+
061-2208	\$8.80	8.40	7.80

F CONNECTOR REMOVAL TOOL

- Easily remove and insert connectors with the hex socket.



ORDER CODE	1-9	10-19	20+
061-2208F	\$9.68	9.24	8.58

PUNCH DOWN TOOLS

5-PAIR 110 PUNCH DOWN TOOL

- Reduce 110-type LAN and telecommunication distribution system installation time.
- Used on both cable and cross-connect sides of 110-type termination block.
- Terminates and cuts up to five pairs of UTP at the same time.
- Rubber handle design provides comfortable use.
- Features reversible blades for seating conductors without cutting.



ORDER CODE	1-9	10-19	20+
061-315DR	\$80.96	77.28	71.76

IMPACT PUNCH DOWN TOOL AND REPLACEMENT BLADE

- Easy grip handle.
- Includes 110 or 66 insert and cut blade.
- Easy to use spring loaded design.
- Interchangeable blades.
- Storage compartment for additional blade.



ORDER CODE	DESCRIPTION	1-9	10-19	20+
061-110P	Impact Tool with 110 Blade	\$31.68	30.24	28.08
061-66P	Impact Tool with 66 Blade	35.20	33.60	31.20
061-601A	Blade for 66 Terminal	10.56	10.08	9.36
061-601B	Blade for 110 Terminal	10.56	10.08	9.36

ORDER CODE	TERMINAL TYPE	BODY	BLADE
061-66P	66	X	X
061-110P	110	X	X
061-601A	66		X
061-601B	110		X

CABLE TIES

CABLE TIES

- Color: Natural Nylon. 100 pcs/pack.

ORDER CODE	LENGTH	WIDTH	MAX DIA	TENSILE STRENGTH	1-9	10-19	20+
06B-100MC	3.9"	0.10"	0.7"	18 lbs	\$1.41	1.34	1.25
06B-160MC	6.5"	0.10"	1.6"	18 lbs	2.64	2.52	2.34
06B-200MC	8.0"	0.10"	2.0"	18 lbs	3.17	3.02	2.81
06B-1401C	5.3"	0.14"	1.4"	40 lbs	2.73	2.60	2.42
06B-2001C	8.1"	0.14"	2.0"	40 lbs	4.40	4.20	3.90
06B-190STC	7.4"	0.19"	1.7"	50 lbs	5.28	5.04	4.68
06B-370STC	14.8"	0.19"	4.0"	50 lbs	9.68	9.24	8.58
06B-430STC	16.9"	0.19"	4.5"	50 lbs	17.95	17.14	15.91

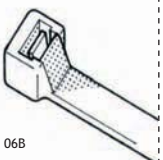

06B

MOUNTABLE HEAD TIES

- Secure bundled harnesses to panels.
- Color: Natural Nylon. 100 pcs/pack.

ORDER CODE	LENGTH	WIDTH	MAX DIA	TENSILE STRENGTH	1-9	10-19	20+
06C-1501C	5.9"	0.14"	1.2"	40 lbs	\$4.75	4.54	4.21
06C-200ST	8.0"	0.19"	2.1"	50 lbs	7.04	6.72	6.24
06C-380HD	15.0"	0.30"	3.0"	120 lbs	29.92	28.56	26.52

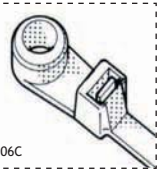

06C

MARKER TIES

- Provides clean, permanent identification of drop of wires and wire bundles.
- Color: Natural Nylon. 100 pcs/pack.

ORDER CODE	LENGTH	WIDTH	MAX DIA	TENSILE STRENGTH	PAD SIZE	1-9	10-19	20+
06D-100MC	3.9"	0.10"	0.70"	18 lbs	0.3" x 1.0"	\$4.58	4.37	4.06
06D-110MC	4.3"	0.10"	0.70"	18 lbs	0.3" x 0.8"	4.75	4.54	4.21

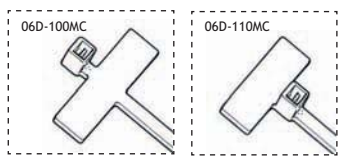

06D-100MC

06D-110MC

CABLE TIE MOUNT

- Can be secured with #8 screw, accepting cable ties up to 0.19" width.
- Color: Natural Nylon. 100 pcs/pack.

ORDER CODE	MOUNTING TYPE	BASE SIZE	CABLE TIE ACCEPTED	HEIGHT	1-9	10-19	20+
06E-3AC	Adhesive	0.75" x 0.75"	Up to 0.138"W	1/5"	\$13.20	12.60	11.70
06E-4AC	Adhesive/Screw	1.10" x 1.10"	Up to 0.190"W	2/7"	19.18	18.31	17.00



(06E)

RATCHET COAXIAL CRIMPING TOOLS

- Metal frame with built-in ratchet.
- So FT rubber handle grips.
- Interchangeable die set.
- Three-piece crimp for BNC, TNC, UHF, and SMA.



ORDER CODE	CABLE TYPE	DIE SIZE	1-9	10-19	20+
061-230I	RG-58, 59, 6, 174	0.311", 0.248", 0.204"	\$32.56	31.08	28.86
061-230PA	RG-55, 58, 59, 62, 5, 6, 21, 141, 142, 143, 210, 212, 222, 223, 303, 304, 400, Belden 8279, 8281, 9231, 9141	0.324", 0.255", 0.213", 0.10", 0.068"	32.56	31.08	28.86
061-301A	RG-59, 62, 140, 210, 55, 58, 141, 142, 223, 303, 400, Belden 8279, Fiber Optic	0.256", 0.213", 0.068"	26.40	25.20	23.40

NEW COAXIAL CABLE STRIPPER

- New Patented two step stripper.
- For RG 59, 59Tef, 6, 6Tef, 62.
- Push in Twist and Pull.
- Perfect for Compression Connectors.
- Clips onto your shirt pocket.



ORDER CODE	1-9	10-19	20+
130-TL-59-6	\$8.71	8.32	7.72

COAXIAL STRIPPING TOOLS

- Patented three blade design.
- Strips RG/U 58/59/6/62 coaxial cables.
- Sturdy, light-weight design.
- Replaceable blade set.



ORDER CODE	1-9	10-19	20+
130-AS103	\$16.72	15.96	14.82

- Adjustable for RG 58/59/6/62 coaxial PVC cables.
- Adjustable 3-steps blade-cutter setter included.
- Injection molded thermoplastic body.

ORDER CODE	1-9	10-19	20+
130-CX-STRP	14.08	13.44	12.48

COAXIAL CRIMPING TOOL

- For coaxial (RG-58, 59, 62) cables.
- All steel body, crimp ferrule and pin.
- Full cycle ratcheting design.
- Interchangeable die set.



130-CX-CRMP

F-SERIES CRIMP TOOLS

- HEX TYPE

- Deluxe hex crimp, steel frame with rigid handle grips.
- Design to work with RJ-59/62/6 coaxial cables.
- Die set size: 0.322" and 0.255".



061-106H

- OVAL TYPE

- Parallel crimp action.
- Surfaced by nickel plating with so FT rubber handles.
- Designed to crimp F connector in RG-59/62, 8, 11 oval types.



061-102-O

TERMINAL CRIMPING TOOL

- Ratchet type; for crimping 10-22 AWG non-insulated open barrel connectors and D-Sub, V.35 connectors.



061-301U

ORDER CODE	CABLE SIZE	CRIMP TYPE	1-9	10-19	20+
130-CX-CRMP	RG-58, 59, 62	BNC	\$36.96	35.28	32.76
061-106H	RG-59, 62, 6	Hex-Shape F Connector	18.48	17.64	16.38
061-102-O	RG-56, 59	Oval-Shape F Connector	6.34	6.05	5.62
061-301U	14 - 22 AWG	Non-Insulated Open Barrel and D-Sub, V.35 Connectors	31.68	30.24	28.08

WIRE TOOLS

WIRE CUTTING, STRIPPING, & CRIMPING TOOL

- 7-in-1 crimping tool: Wire stripper, wire cutter, steel-wire cutter, plier, wire loop, scale mm and inch, crimping tool.

ORDER CODE	STRIP SIZE	1-9	10-19	20+
061-1041	10, 12, 14, 16, and 18 AWG	\$6.34	6.05	5.62
061-1042	16, 18, 20, 22, 24, and 26 AWG	6.34	6.05	5.62
061-1043	22, 24, 26, 28, and 30 AWG	6.34	6.05	5.62



061-1041

WIRE CUTTING, STRIPPING TOOL

- 5.25", made with carbon steel, hardened and with grinding stripper.
- Strips wire sizes from 10-30 AWG.

ORDER CODE	1-9	10-19	20+
061-223	\$4.84	4.62	4.29



061-223

ECONOMICAL ELECTRICAL CUTTER & STRIPPER

- Made of carbon steel and hardened with black oxide finish.
- Flush cutting with small hole to strip wire from 20 to 24 AWG (0.50-0.80 mm).

ORDER CODE	1-9	10-19	20+
061-1091	\$4.10	3.91	3.63



061-1091

ECONOMICAL WIRE CUTTING TOOL

- 6.5" long frame; cuts multiple conductors and round cables O.D. up to 0.41" (10.5mm).
- Made of carbon steel and hardened with black oxide finish.

ORDER CODE	1-9	10-19	20+
061-206	\$7.04	6.72	6.24



061-206

PRECISE CUTTER & STRIPPER

- Made of carbon steel and hardened with black oxide finish.
- Flat cable cutter for cutting ribbon cable.

ORDER CODE	1-9	10-19	20+
061-502C	\$9.68	9.24	8.58



061-502C

ORDER CODE	CUTTING WIRE SIZE (AWG)	CUTTING WIRE O.D.	CUT	STRIP	CRIMP
061-1041	10, 12, 14, 16, 18	5.50mm - 0.9mm	x	x	x
061-1042	16, 18, 20, 22, 24, 26	1.25mm - 0.20mm	x	x	x
061-1043	22, 24, 26, 28, 30	0.65mm - 0.25mm	x	x	x
061-1091	20-24	0.50mm - 0.80mm	x	x	
061-206		Up to 10.5mm	x		
061-223	30 - 10	0.50mm - 4.00mm	x	x	
061-502C		300mm	x	x	

FLAT / ROUND CABLE TOOLS

ROUND CABLE STRIPPER / 110 INSERTION TOOL

- Ideal for stripping off the outside jacket of the round 1-4 pair UTP cable.
- Built-in 110 insertion tool on one end.

ORDER CODE	1-9	10-19	20+
061-ST	\$1.67	1.60	1.48



ROUND & FLAT CABLE STRIPPING TOOL

- Strips and cuts 2, 4, 6, 8, and 10 conductor cables.
- Adjustable screw to fit insulation of different outside diameter, avoiding damage of the inner conductors.

ORDER CODE	1-9	10-19	20+
061-501	\$9.68	9.24	8.58



VELCRO GRIP TIES & GRIP TIE ROLLS

- Low profile, one-piece fastening device.
- Constructed of VELCRO polyethylene hook and nylon loop, laminated back-to-back.
- Features quick release for repetitive access to cables and wires.
- Ideal for copper or fiber optic cable installation.
- Available in 6 colors as well as different sizes.
- Black is also available on a roll, allowing custom length for specific application.



ORDER CODE	DESCRIPTION	1-4	5-9	10+
06A-506-XX	Grip Tie, 6" x 0.5", 10pcs/pack	\$7.92	7.56	7.02
06A-508-XX	Grip Tie, 8" x 0.5", 10pcs/pack	8.89	8.48	7.88
06A-5011-XX	Grip Tie, 11" x 0.5", 10pcs/pack	10.56	10.08	9.36
06A-7515-XX	Grip Tie, 15" x 0.75", 10pcs/pack	21.03	20.08	18.64
06A-75180-BK	Grip Tie Roll, 180" x 0.75", Black	17.16	16.38	15.21

XX = Color BL GN RD OR YL BK

HOME WIRING PRODUCTS



HomeVue puts you in control of your home's wiring resources without relying on a certain manufacturer.

- Provides inbound and outbound media to every room.
- Create a home office or add a web camera in the nursery.
- Enjoy full access of home entertainment with a remote control.

VISIT WWW.TNTHOMEVUE.COM
FOR PRODUCT DETAILS

****PLEASE CALL FOR PRICE****



DESCRIPTIONS	6 ZONES (6M) Box Size: 24" x 14.25" x 3.75"		12 ZONES (12M) Box Size: 36" x 14.25" x 3.75"		18 ZONES (18M) Box Size: 48" x 14.25" x 3.75"	
		The 6 Zones system includes a box, door, 2 destination modules (distribute to 6 locations), and a management bar.		The 12 Zones system includes a box, door, 4 destination modules (distribute to 12 locations), 2 management bar, and a power extension box.		The 18 Zones system includes a box, door, 6 destination modules (distribute to 18 locations), 3 management bar, and a power extension box.
EXPRESS	PRODUCT	CODE	PRODUCT	CODE	PRODUCT	CODE
	6 Passive Video	H07-16-PAS	8 Active Video	H07-18-BID	8 Active Video	H07-18-BID
	8-Port Telecom	H06-18-EXT	8-Port Telecom + RJ31	H06-18-RJ31	1 Modulator Input	H07-11-MOD
				8-Port Telecom + RJ31	H06-18L-RJ31	
				4-Port Ethernet Switch	H07-EB1040	
	UNIT CODE: H01-EXPRESS-06		UNIT CODE: H01-EXPRESS-12		UNIT CODE: H01-EXPRESS-18	
MASTER	PRODUCT	CODE	PRODUCT	CODE	PRODUCT	CODE
	6 Passive Video	H07-16-PAS	8 Active Video	H07-18-BID	8 Enhanced Video	H07-38-BID-MO
	8-Port Telecom	H06-18-EXT	1 Modulator Input	H07-11-MOD	8 Active Video	H07-18-BID
				2 Modulator Input	H07-11-MOD X2	
				8-Port Telecom + RJ31	H06-18L-RJ31	
				4-Port Ethernet Router	H07-BR1300	
	UNIT CODE: H01-MASTER-06		UNIT CODE: H01-MASTER-12		UNIT CODE: H01-MASTER-18	
ULTRA	PRODUCT	CODE	PRODUCT	CODE	PRODUCT	CODE
	8 Active Video	H07-18-BID	8 Enhanced Video	H07-38-BID-MO	8 Enhanced Video	H07-38-BID-MO
	8-Port Telecom + RJ31	H06-18-RJ31	6 Passive Video	H07-16-PAS	8 Active Video	H07-18-BID
				3 Modulator Input	H07-11-MOD X3	
				2 Modulator Input	H07-11-MOD X2	
				16-Port Telecom + RJ31	H06-116L-RJ31	
				4-Port Ethernet Router	H07-BR1300	
	UNIT CODE: H01-ULTRA-06		UNIT CODE: H01-ULTRA-12		UNIT CODE: H01-ULTRA-18	
	REMARKS: Cables not included. Recommend 500 feet. Composite Cable		REMARKS: Cables not included. Recommend 2x500 feet. Composite Cable		REMARKS: Cables not included. Recommend 3x500 feet. Composite Cable	

HOME WIRING MODULES

A. H07-18-BID

- 1 x 8 Bi-Directional Video Distribution.
- 2-way House Amplifier with digital TV ready.
- Low insertion loss, high return loss and isolation.

B. H07-16-PAS

- 1 x 6 Passive Video Distribution.
- Zinc die cast housing with nickel-plated.
- 5 - 1000 MHz with vertical ports.

C. H07-38-BID-MO

- 3 x 8 Bi-Directional Video Distribution with Modulator Input.
- 2-way House Amplifier with digital TV ready.
- Virtually constant level of gain.
- Low insertion loss, high return loss and isolation.

D. H06-18-EXT

- 1 x 8 HomeVue Extension Telecom Module.
- 1 in 8 out RJ-45 Telecom module.
- Up to 4 lines available.

E. H06-18-RJ31

- 1 x 8 HomeVue RJ31 Telecom Module.
- 1 in 8 out RJ-45 telecom module with RJ31 security port.
- Up to 4 lines available, and multi-line chooser.

F. H06-116-RJ31

- 1 x 16 HomeVue RJ31 Telecom Module.
- 1 in 16 out RJ-45 telecom module with RJ31 security port.
- Up to 4 lines available, and multi-line chooser.

G. H07-EB1040

- 5-Port Ethernet Switch.
- A switch providing home networking service.
- Up to 5 different users.

H. H07-BR1300

- 4-Port Ethernet Router.
- Cable/DSL router providing sharing for the home networking.
- Provides same internet speed and up to 4 different users.

I. H04-HS2

- 2U Half-Size Destination Module.
- A module contains RJ-45 jacks and F connectors to the wall plates.
- Easy color layout design.

TOOLS & HARDWARE

061-ST (page 39)	061-501 (page 39)	061-230PA (page 39)	069-TNT-N (page 35)
061-1041 (page 39)	130-CX-STRP (page 39)	061-110P (page 38)	071-XXX (page 29)
07F-I88 (page 21)	05BH (page 28)	05BK (page 28)	H50FF Series (page 47)
H12-F-CP	061-DL8083R		
ORDER CODE	DESCRIPTION	UNIT PRICE	
061-DL8083R	F Connector Compression Tool	\$51.04	
H12-F-CP	F Connector Compression Type	0.51	

COMPOSITE CABLES

BELDEN HOMECHOICE "BANANA PEEL" COMPOSITE CABLE

- Features a design that affixes the individual cables to a center spine-eliminating the need to strip off the outer jacket.
- The individual Data (Cat 5E 4 pair bonded, blue and green jackets), coaxial (RG-6, black and white jackets), and fiber cables (Orange jacket) are all instantly identifiable.
- Smaller OD than traditional composite cables - improving overall bend radius for faster and easier installations.

ORDER CODE **DESCRIPTION** **UNIT PRICE**

BN-7876S Two Cat5E 4-pair UTP and Two RG-6 coaxial cables, 500 feet *Please Call for Price*

BN-7878S Two Cat5E 4-pair UTP, Two RG-6 coaxial, and One 2-fiber 62.5/125/900 cables, 500 feet *Please Call for Price*

BELDEN HOMECHOICE COMPOSITE CABLE

- Features DataTwist 350 data cables with Belden's patented bonded pair construction and Duobond Plus coaxial cables.
- UL verified to Category 5E standard.
- Green color Jacket, Flame-retardant PVC.

HOMECHOICE™

ORDER CODE **DESCRIPTION** **UNIT PRICE**

BN-7876A Two Cat5E 4-pair UTP and Two RG-6 coaxial cables, 500 feet *Please Call for Price*

BN-7878A Two Cat5E 4-pair UTP, Two RG-6 coaxial, and One 2-fiber 62.5/125/900 cables, 500 feet *Please Call for Price*

AUDIO CABLES

- 2 RCA to 2 RCA Cable - Stereo Audio for Analog / Digital.
- Cable : Mini Coaxial Cable.

ORDER CODE	LENGTH	1-24	25-49	50+
C30-2RM-2RM-03	3 feet	\$4.75	4.54	4.21
C30-2RM-2RM-06	6 feet	5.28	5.04	4.68
C30-2RM-2RM-12	12 feet	7.04	6.72	6.24



- 3.5 mm Stereo to 2 RCA Cable - Stereo Audio Y Cable for analog.
- Cable : Copper Wire With Double Shielded.

ORDER CODE	LENGTH	1-24	25-49	50+
C30-SM-2RM-03	3 feet	\$3.52	3.36	3.12
C30-SM-2RM-06	6 feet	4.22	4.03	3.74
C30-SM-2RM-12	12 feet	5.98	5.71	5.30



VIDEO CABLES

- 1 RCA to 1 RCA Video Cable - for Analog/Digital.
- Cable : Mini Coaxial Cable.

ORDER CODE	LENGTH	1-24	25-49	50+
C30-RM-RM-03	3 feet	\$1.76	1.68	1.56
C30-RM-RM-06	6 feet	2.29	2.18	2.03
C30-RM-RM-12	12 feet	3.52	3.36	3.12



- S-Video to S-Video Video Cable - for Analog/Digital.
- Cable : Mini Coaxial Cable.

ORDER CODE	LENGTH	1-24	25-49	50+
C28-MDIN4-MM-03	3 feet	\$3.61	3.44	3.20
C28-MDIN4-MM-06	6 feet	5.19	4.96	4.60
C28-MDIN4-MM-12	12 feet	8.36	7.98	7.41



- Component (3X) RCAs to (3X) RCAs Video Cable - for Analog/Digital.
- Cable : Mini Coaxial Cable.

ORDER CODE	LENGTH	1-24	25-49	50+
C30-3RM-RGB-03	3 feet	\$4.84	4.62	4.29
C30-3RM-RGB-06	6 feet	7.04	6.72	6.24
C30-3RM-RGB-12	12 feet	11.44	10.92	10.14



Y-ADAPTER CABLE

- 1 RCA Male to 2 RCA Female cable for Analog/Digital.
- Cable : Mini Coaxial cable.

ORDER CODE	LENGTH	1-24	25-49	50+
C31-RM-2RF	18 inches	\$2.46	2.35	2.18



- 1 RCA Female to 2 RCA Male cable for Analog/Digital.
- Cable : Mini Coaxial cable.

ORDER CODE	LENGTH	1-24	25-49	50+
C31-RF-2RM	18 inches	\$2.46	2.35	2.18



- 3.5 mm A/V to 3 RCA Male - Stereo A/V Camcorder cable for analog.
- Cable : Copper wire with double shielded.

ORDER CODE	LENGTH	1-24	25-49	50+
C31-SM-3RM	6 feet	\$5.63	5.38	4.99



TOSLINK CABLES

TOSLINK CABLES - PLASTIC FIBER CABLES

- Toslink to Toslink - Dolby Digital Service.
- Cable : Plastic Fiber Optics.

ORDER CODE	LENGTH	1-24	25-49	50+
C30-TL-03	3 feet	\$2.99	2.86	2.65
C30-TL-06	6 feet	4.00	4.20	3.90
C30-TL-12	12 feet	7.48	7.14	6.63



- Toslink + S-Video both sides - Stereo Audio/Video.
- Cable : Plastic Fiber Optics + Mini Coaxial.

ORDER CODE	LENGTH	1-24	25-29	50+
C30-TLSV-03	3 feet	\$11.97	11.42	10.61
C30-TLSV-06	6 feet	13.55	12.94	12.01
C30-TLSV-12	12 feet	16.90	16.13	14.98



- Toslink + Component RCAs both sides - Stereo Audio/Video.
- Cable : Plastic Fiber Optics + Mini Coaxial.

ORDER CODE	LENGTH	1-24	25-49	50+
C30-TL3RM-03	3 feet	\$21.65	20.66	19.19
C30-TL3RM-06	6 feet	24.82	23.69	22.00
C30-TL3RM-12	12 feet	31.42	29.99	27.85



AUDIO/VIDEO COMBINATION CABLES

- 2 RCA (Audio) + 1 RCA(Video) - Stereo Audio + Video for Analog/Digital.
- Cable : Mini Coaxial Cable.

ORDER CODE	LENGTH	1-24	25-49	50+
C30-3RM-AV-03	3 feet	\$4.84	4.62	4.29
C30-3RM-AV-06	6 feet	7.04	6.72	6.24
C30-3RM-AV-12	12 feet	11.44	10.92	10.14



- 2 RCA (Audio) + S-Video (Video) - Stereo Audio + Video for Analog/Digital.
- Cable : Mini Coaxial Cable.

ORDER CODE	LENGTH	1-24	25-49	50+
C30-2RM-SV-03	3 feet	\$7.13	6.80	6.32
C30-2RM-SV-06	6 feet	10.91	10.42	9.67
C30-2RM-SV-12	12 feet	18.48	17.64	16.38



- 2 RCA (Audio) + 3 RCA (Video) - Stereo Audio + Component Cable for Analog/Digital.
- Cable : Mini Coaxial.

ORDER CODE	LENGTH	1-24	25-49	50+
C30-5RM-5RM-03	3 feet	\$9.33	8.90	8.27
C30-5RM-5RM-06	6 feet	13.02	12.43	11.54
C30-5RM-5RM-12	12 feet	20.06	19.15	17.78



S-VIDEO & VGA MONITOR CABLES

S-VIDEO CABLE

- Mini Din 4 to Min Din 4.

ORDER CODE	DESCRIPTION	1-24	25-49	50+
C28-MDIN4-MM-03	Male/Male, 3 ft	\$3.61	3.44	3.20
C28-MDIN4-MM-06	Male/Male, 6 ft	5.19	4.96	4.60
C28-MDIN4-MM-12	Male/Male, 12 ft	8.36	7.98	7.41
C28-MDIN4-MM-25	Male/Male, 25 ft	15.22	14.53	13.49
C28-MDIN4-MM-50	Male/Male, 50 ft	28.25	26.96	25.04
C28-MDIN4-MM-75	Male/Male, 75 ft	41.18	39.31	36.50
C28-MDIN4-MM-100	Male/Male, 100 ft	54.56	52.08	48.36
C28-MDIN4-MF-03	Male/Female, 3 ft	3.61	3.44	3.20
C28-MDIN4-MF-06	Male/Female, 6 ft	5.19	4.96	4.60
C28-MDIN4-MF-12	Male/Female, 12 ft	8.36	7.98	7.41
C28-MDIN4-MF-25	Male/Female, 25 ft	15.22	14.53	13.49
C28-MDIN4-MF-50	Male/Female, 50 ft	28.25	26.96	25.04



COMPONENT CABLE

HIGH DENSITY DB-15M TO RCA COMPONENT CABLE

- Cable: UL2919, 28 AWG to 3 Coax.
- Jacket Color: Black Matte PVC and OD = 7.0 ± 0.15mm.
- Connector: High Density D-Sub 15-Pin Male to 3 RCA Male.
- Gold Plated Pins and Nickel Plated Shell.
- Strain Relief Molding 45P Black PVC.

ORDER CODE	LENGTH	1-24	25-49	50+
C32-HD15M-3RM-1M	1 Meter	\$12.32	11.76	10.92
C32-HD15M-3RM-2M	2 Meters	14.96	14.28	13.26
C32-HD15M-3RM-3M	3 Meters	17.60	16.80	15.60



STEREO AUDIO SPLITTER CABLE

- 1 STEREO MALE TO
- 2 STEREO FEMALE CABLE

ORDER CODE	LENGTH	1-24	25-49	50+
C30-SM-2SF-01	1 foot	\$2.04	1.95	1.81



TYPE A BASIC RUN CABLES - DIN14 PIN FEMALE TO DIN14 PIN FEMALE - PVC & PLENUM VERSION



TYPE A BASIC RUN CABLE

- 3x28 AWG Coaxial Cables with Braided Copper Shielding, 3x24 AWG Twisted Pair and a single 24 AWG Pair, Mylar™ Foil Shield
- UXGA Supports PC Resolutions up to 1600 x 1200 Pixels
- Includes protective caps with pulling eyes that are able to withstand a maximum pulling tension of 30 pounds
- Available in CL2-rated PVC jacket for residential installations and CMP jacket for commercial installations

PART NO.	DESCRIPTION	1-24	25-49	50+
EZ01-A-15	PVC 15 feet	\$16.46	\$15.71	\$14.59
EZ01-A-25	PVC 25 feet	\$23.67	\$22.60	\$20.98
EZ01-A-35	PVC 35 feet	\$30.80	\$29.40	\$27.30
EZ01-A-50	PVC 50 feet	\$41.54	\$39.65	\$36.82
EZ01-A-75	PVC 75 feet	\$59.49	\$56.78	\$52.73
EZ01-A-100	PVC 100 feet	\$77.44	\$73.92	\$68.64
EZ01-A-125	PVC 125 feet	\$91.52	\$87.36	\$81.12
EZ01-A-150	PVC 150 feet	\$112.29	\$107.18	\$99.53
EZ02-A-15	PLENUM 15 feet	\$45.14	\$43.09	\$40.01
EZ02-A-25	PLENUM 25 feet	\$72.16	\$68.88	\$63.96
EZ02-A-35	PLENUM 35 feet	\$98.56	\$94.08	\$87.36
EZ02-A-50	PLENUM 50 feet	\$139.04	\$132.72	\$123.24
EZ02-A-75	PLENUM 75 feet	\$200.64	\$191.52	\$177.84
EZ02-A-100	PLENUM 100 feet	\$260.48	\$248.64	\$230.88
EZ02-A-125	PLENUM 125 feet	\$332.64	\$317.52	\$294.84
EZ02-A-150	PLENUM 150 feet	\$397.76	\$379.68	\$352.56

TYPE B BASIC RUN CABLES - DIN14 PIN FEMALE TO DIN14 PIN FEMALE - PVC & PLENUM VERSION



TYPE B BASIC RUN CABLE

- 5x28 AWG Coaxial cables with Mylar™ Foil and 85% Braided Copper Shielding
- Ideal for A/V and Component Video Applications Compatible with Analog and S/PDIF Digital Audio
- Includes protective caps with pulling eyes that are able to withstand a maximum pulling tension of 30 pounds
- Available in CL2-rated PVC jacket for residential installations and CMP jacket for commercial installations

PART NO.	DESCRIPTION	1-24	25-49	50+
EZ01-B-15	PVC 15 feet	\$18.48	\$17.64	\$16.38
EZ01-B-25	PVC 25 feet	\$27.81	\$26.54	\$24.65
EZ01-B-35	PVC 35 feet	\$36.87	\$35.20	\$32.68
EZ01-B-50	PVC 50 feet	\$50.78	\$48.47	\$45.01
EZ01-B-75	PVC 75 feet	\$72.95	\$69.64	\$64.66
EZ01-B-100	PVC 100 feet	\$87.12	\$83.16	\$77.22
EZ01-B-125	PVC 125 feet	\$103.84	\$99.12	\$92.04
EZ01-B-150	PVC 150 feet	\$114.40	\$109.20	\$101.40
EZ02-B-15	PLENUM 15 feet	\$61.60	\$58.80	\$54.60
EZ02-B-25	PLENUM 25 feet	\$100.32	\$95.76	\$88.92
EZ02-B-35	PLENUM 35 feet	\$137.28	\$131.04	\$121.68
EZ02-B-50	PLENUM 50 feet	\$193.60	\$184.80	\$171.60
EZ02-B-75	PLENUM 75 feet	\$281.60	\$268.80	\$249.60
EZ02-B-100	PLENUM 100 feet	\$374.88	\$357.84	\$332.28
EZ02-B-125	PLENUM 125 feet	\$468.16	\$446.88	\$414.96
EZ02-B-150	PLENUM 150 feet	\$559.68	\$534.24	\$496.08

TYPE C BASIC RUN CABLES - DIN19 PIN FEMALE TO DIN19 PIN FEMALE - PVC & PLENUM VERSION



TYPE C BASIC RUN CABLE

- 4x28 AWG twisted pairs with Mylar™ foil and drain wire, 1x28 AWG twisted pair and 5x28 AWG conductors
- Optimized design for TMDS uncompressed digital video, such as HDMI and DVI application.
- Includes protective caps with pulling eyes that are able to withstand a maximum pulling tension of 30 pounds
- Available in CL2-rated PVC jacket for residential installations and CMP jacket for commercial installations

PART NO.	DESCRIPTION	1-24	25-49	50+
EZ01-C-15	PVC 15 feet	\$21.08	\$20.13	\$18.69
EZ01-C-25	PVC 25 feet	\$28.07	\$26.80	\$24.88
EZ01-C-35	PVC 35 feet	\$34.99	\$33.40	\$31.01
EZ01-C-50	PVC 50 feet	\$45.41	\$43.34	\$40.25
EZ01-C-75	PVC 75 feet	\$55.18	\$52.67	\$48.91
EZ01-C-100	PVC 100 feet (24AWG)	\$151.36	\$144.48	\$134.16
EZ01-C-125	PVC 125 feet (24AWG)	\$206.98	\$197.57	\$183.46
EZ01-C-150	PVC 150 feet (24AWG)	\$244.46	\$233.35	\$216.68
EZ02-C-15	PLENUM 15 feet	\$51.04	\$48.72	\$45.24
EZ02-C-25	PLENUM 25 feet	\$82.72	\$78.96	\$73.32
EZ02-C-35	PLENUM 35 feet	\$110.88	\$105.84	\$98.28
EZ02-C-50	PLENUM 50 feet	\$154.88	\$147.84	\$137.28
EZ02-C-75	PLENUM 75 feet	\$225.28	\$215.04	\$199.68
EZ02-C-100	PLENUM 100 feet (24AWG)	\$361.68	\$345.24	\$320.58

FEATURES:

- Perfect solution for long-run HDMI, DVI and SVGA (HD15) applications
- Basic-run cables and connectors ideal for conduits at just 1-inch OD
- 100% shielded solution, from source to display
- Twist on and off, easy on-site connections, no tools required
- Highly visible, clearly marked color-coded faceplates and cables.

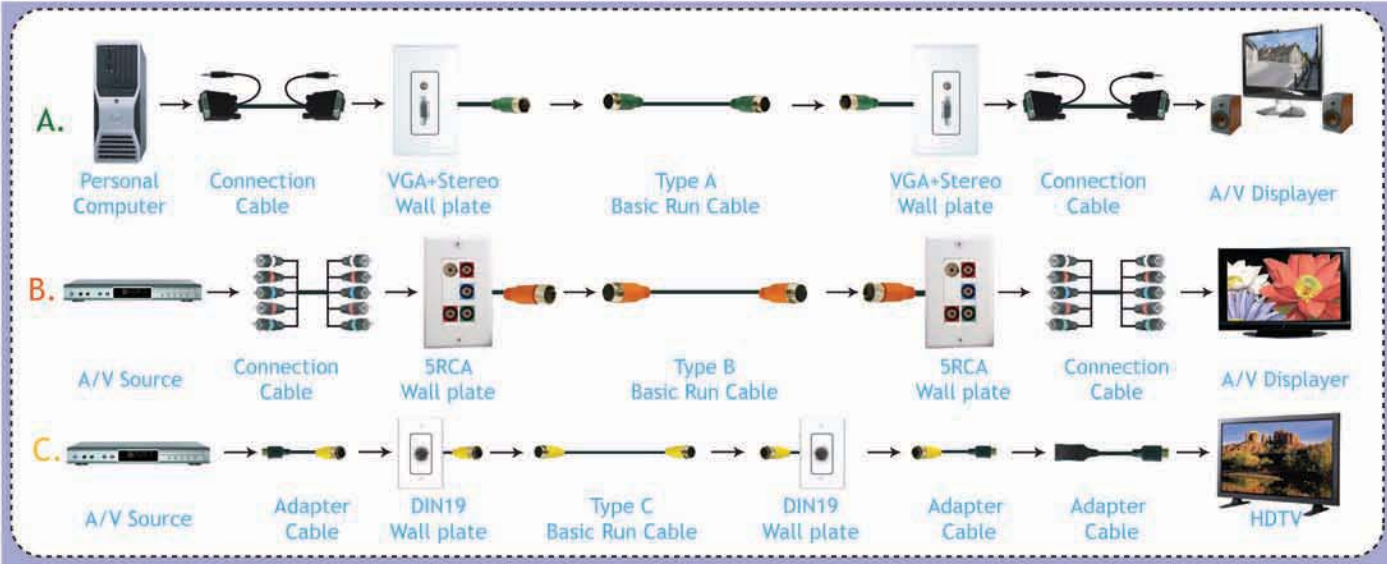

DIN WALLPLATE



PART NO.	DESCRIPTION	1-24	25-49	50+
EZ04-D14A-FP	Din14 Type A Wall Plate	\$10.21	\$9.74	\$9.05
EZ04-D14B-FP	Din14 Type B Wall Plate	\$10.21	\$9.74	\$9.05
EZ04-D19-FP	Din19 Type C Wall Plate	\$11.79	\$11.26	\$10.45

HDMI DIGITAL LINK SOLUTION



PART NO.	DESCRIPTION	1-24	25-49	50+
EZ03-HDMI-01	1 ft Adapter Cable	\$8.45	\$8.06	\$7.49
EZ03-HDMI-03	3 ft Adapter Cable	\$9.86	\$9.41	\$8.74
EZ03-HDMI-06	6 ft Adapter Cable	\$12.00	\$11.46	\$10.64
EZ03-HDMI-10	10 ft Adapter Cable	\$14.92	\$14.25	\$13.23
EZ04-HDMI-FP	HDMI Female Wall Plate	\$11.79	\$11.26	\$10.45

DVI DIGITAL LINK SOLUTION



PART NO.	DESCRIPTION	1-24	25-49	50+
EZ03-DVID-01	1 ft Adapter Cable	\$8.18	\$7.81	\$7.25
EZ03-DVID-03	3 ft Adapter Cable	\$9.50	\$9.07	\$8.42
EZ03-DVID-06	6 ft Adapter Cable	\$11.62	\$11.09	\$10.30
EZ03-DVID-10	10 ft Adapter Cable	\$14.26	\$13.61	\$12.64
EZ04-DVID-FP	DVI Wall Plate	\$11.62	\$11.09	\$10.30

SVGA+STEREO AUDIO SOLUTION

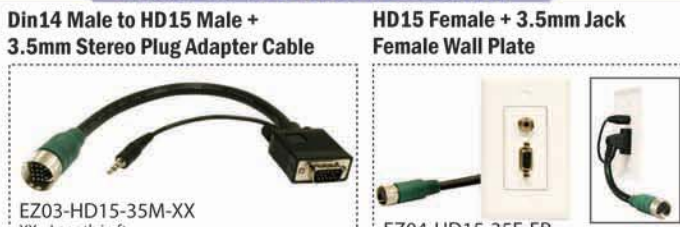

PART NO.	DESCRIPTION	1-24	25-49	50+
EZ03-HD15-35M-01	1 ft Adapter Cable	\$6.95	\$6.64	\$6.16
EZ03-HD15-35M-03	3 ft Adapter Cable	\$8.98	\$8.57	\$7.96
EZ03-HD15-35M-06	6 ft Adapter Cable	\$12.06	\$11.51	\$10.69
EZ03-HD15-35M-10	10 ft Adapter Cable	\$16.19	\$15.46	\$14.35
EZ04-HD15-35F-FP	SVGA+Stereo Audio Wall Plate	\$11.62	\$11.09	\$10.30

DVI DIGITAL LINK + STEREO AUDIO SOLUTION



PART NO.	DESCRIPTION	1-24	25-49	50+
EZ03-DVID-35M-01	1 ft Adapter Cable	\$7.92	\$7.56	\$7.02
EZ03-DVID-35M-03	3 ft Adapter Cable	\$9.77	\$9.32	\$8.66
EZ03-DVID-35M-06	6 ft Adapter Cable	\$12.50	\$11.93	\$11.08
EZ03-DVID-35M-10	10 ft Adapter Cable	\$15.84	\$15.12	\$14.04
EZ04-DVID-35F-FP	DVI+Stereo Audio Wall Plate	\$13.90	\$13.27	\$12.32

SVGA HIGH DENSITY DB15 SOLUTION

Din14 Male to HD DB15 Male Adapter Cable



HD DB15 Female Wall Plate



PART NO.	DESCRIPTION	1-24	25-49	50+
EZ03-HD15-01	1 ft Adapter Cable	\$6.78	\$6.47	\$6.01
EZ03-HD15-03	3 ft Adapter Cable	\$8.62	\$8.23	\$7.64
EZ03-HD15-06	6 ft Adapter Cable	\$9.42	\$8.99	\$8.35
EZ03-HD15-10	10 ft Adapter Cable	\$12.23	\$11.68	\$10.84
EZ04-HD15-FP	SVGA HD Female Wall Plate	\$9.68	\$9.24	\$8.58

COMPOSITE VIDEO + STEREO AUDIO SOLUTION

Din14 Male to 3 RCA Male (RWY) Adapter Cable



3 RCA Composite Wall Plate

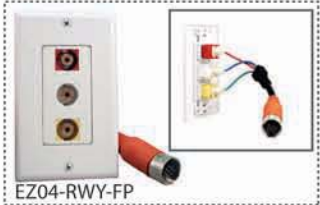

PART NO.	DESCRIPTION	1-24	25-49	50+
EZ03-RWY-01	1 ft Adapter Cable	\$6.16	\$5.88	\$5.46
EZ03-RWY-03	3 ft Adapter Cable	\$6.95	\$6.64	\$6.16
EZ03-RWY-06	6 ft Adapter Cable	\$8.10	\$7.73	\$7.18
EZ03-RWY-10	10 ft Adapter Cable	\$10.03	\$9.58	\$8.89
EZ04-RWY-FP	3RCA Composite Wall Plate	\$11.62	\$11.09	\$10.30

COMPONENT VIDEO 3RCA (RGB) SOLUTION

Din14 Male to 3 RCA Male (RGB) Adapter Cable



3 RCA Component Wall Plate



PART NO.	DESCRIPTION	1-24	25-49	50+
EZ03-RGB-01	1 ft Adapter Cable	\$6.16	\$5.88	\$5.46
EZ03-RGB-03	3 ft Adapter Cable	\$6.95	\$6.64	\$6.16
EZ03-RGB-06	6 ft Adapter Cable	\$8.10	\$7.73	\$7.18
EZ03-RGB-10	10 ft Adapter Cable	\$10.03	\$9.58	\$8.89
EZ04-RGB-FP	3RCA Component Wall Plate	\$11.62	\$11.09	\$10.30

COMPONENT VIDEO + STEREO AUDIO SOLUTION

Din14 Male to 5 RCA Male Adapter Cable



5 RCA Component A/V Wall Plate



PART NO.	DESCRIPTION	1-24	25-49	50+
EZ03-5RCA-01	1 ft Adapter Cable	\$7.53	\$7.19	\$6.68
EZ03-5RCA-03	3 ft Adapter Cable	\$9.86	\$9.41	\$8.74
EZ03-5RCA-06	6 ft Adapter Cable	\$13.38	\$12.77	\$11.86
EZ03-5RCA-10	10 ft Adapter Cable	\$17.42	\$16.63	\$15.44
EZ04-5RCA-FP	5RCA Female Wall Plate	\$14.96	\$14.28	\$13.26

COMPOSITE VIDEO + STEREO AUDIO (3RCA) + S-VIDEO (MINI DIN 4) SOLUTION

Din14 Male to 3 RCA + MDIN4 Adapter Cable



3 RCA Female + MDIN4 Female Wall Plate



PART NO.	DESCRIPTION	1-24	25-49	50+
EZ03-MD4-01	1 ft Adapter Cable	\$7.30	\$6.97	\$6.47
EZ03-MD4-03	3 ft Adapter Cable	\$9.59	\$9.16	\$8.50
EZ03-MD4-06	6 ft Adapter Cable	\$13.11	\$12.52	\$11.62
EZ03-MD4-10	10 ft Adapter Cable	\$17.86	\$17.05	\$15.83
EZ04-MD4-FP	3RCA+MDIN4 Wall Plate	\$14.08	\$13.44	\$12.48

COMPONENT VIDEO (3RCA) + DIGITAL AUDIO (1RCA) SOLUTION

Din14 Male to 4 RCA Male Adapter Cable



4 RCA Female Wall Plate



PART NO.	DESCRIPTION	1-24	25-49	50+
EZ03-4RCA-01	1 ft Adapter Cable	\$6.95	\$6.64	\$6.14
EZ03-4RCA-03	3 ft Adapter Cable	\$9.24	\$8.82	\$8.19
EZ03-4RCA-06	6 ft Adapter Cable	\$12.76	\$12.18	\$11.31
EZ03-4RCA-10	10 ft Adapter Cable	\$17.53	\$16.73	\$15.54
EZ04-4RCA-FP	4RCA Female Wall Plate	\$13.38	\$12.77	\$11.86

COMPONENT VIDEO (3BNC) SOLUTION

Din14 Male to 3 BNC Male Adapter Cable



3 BNC Female Wall Plate



PART NO.	DESCRIPTION	1-24	25-49	50+
EZ03-3BNC-01	1 ft Adapter Cable	\$9.68	\$9.24	\$8.58
EZ03-3BNC-03	3 ft Adapter Cable	\$10.65	\$10.16	\$9.44
EZ03-3BNC-06	6 ft Adapter Cable	\$12.14	\$11.59	\$10.76
EZ03-3BNC-10	10 ft Adapter Cable	\$14.08	\$13.44	\$12.48
EZ04-3BNC-FP	3BNC Female Wall Plate	\$14.43	\$13.78	\$12.79

COMPONENT VIDEO RGBHV (5BNC) SOLUTION

Din14 Male to 5BNC Male Adapter Cable



5 BNC Female Wall Plate



PART NO.	DESCRIPTION	1-24	25-49	50+
EZ03-5BNC-01	1 ft Adapter Cable	\$13.90	\$13.27	\$12.32
EZ03-5BNC-03	3 ft Adapter Cable	\$16.19	\$15.46	\$14.35
EZ03-5BNC-06	6 ft Adapter Cable	\$19.62	\$18.73	\$17.39
EZ03-5BNC-10	10 ft Adapter Cable	\$24.29	\$23.18	\$21.53
EZ04-5BNC-FP	5BNC Female Wall Plate	\$19.18	\$18.31	\$17.00

[VGA + STEREO AUDIO] + [3RCA (COMPOSITE-RWY)] SOLUTION 1A

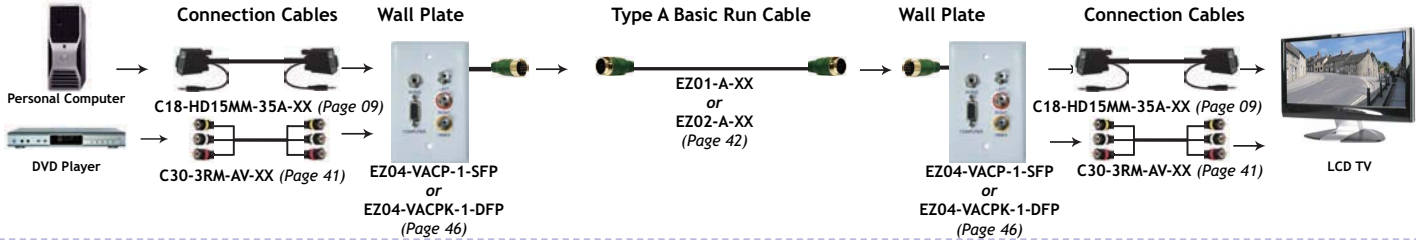

[VGA + STEREO AUDIO] + [3RCA (COMPOSITE-RWY)] SOLUTION 1B

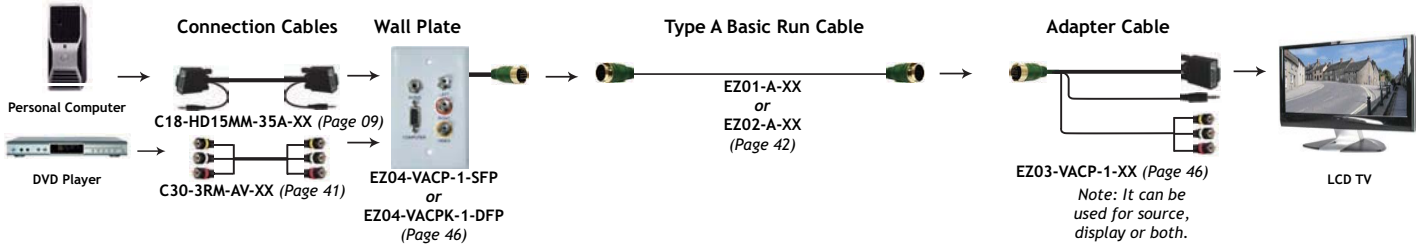

[VGA + STEREO AUDIO] + [3RCA (COMPOSITE-RWY)] SOLUTION 2A

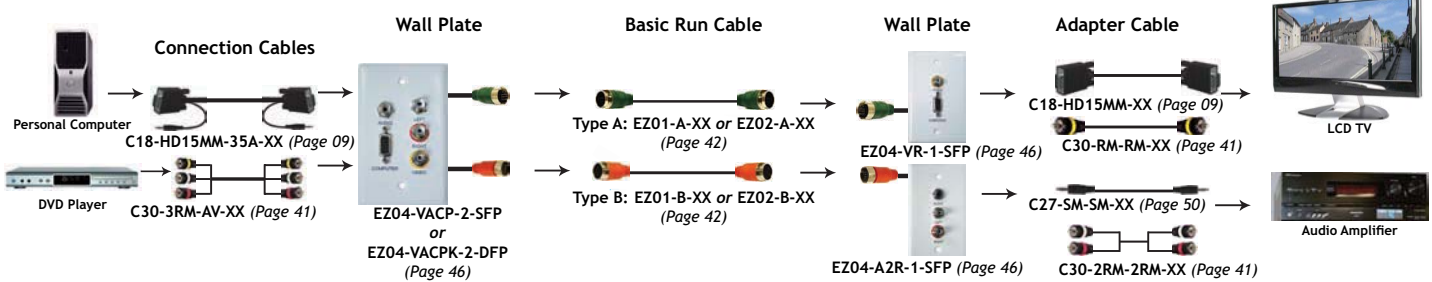

[VGA + STEREO AUDIO] + [3RCA (COMPOSITE-RWY)] SOLUTION 2B

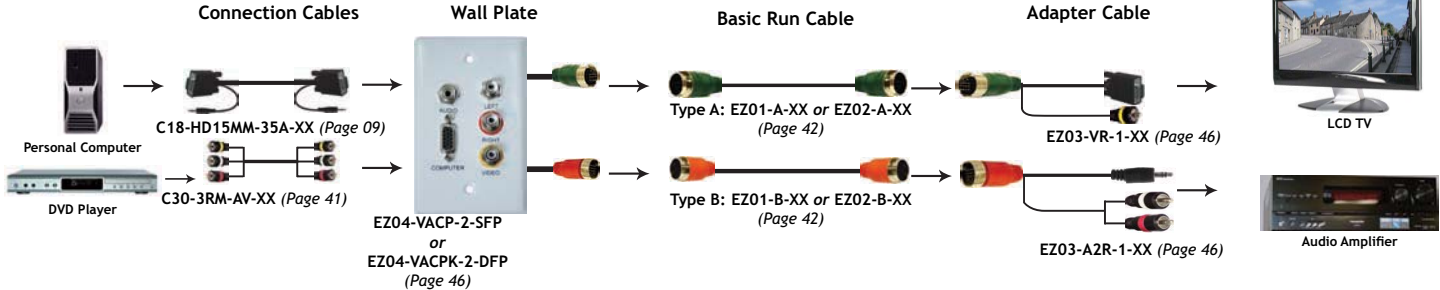

[VGA + STEREO AUDIO] + 5RCA SOLUTION

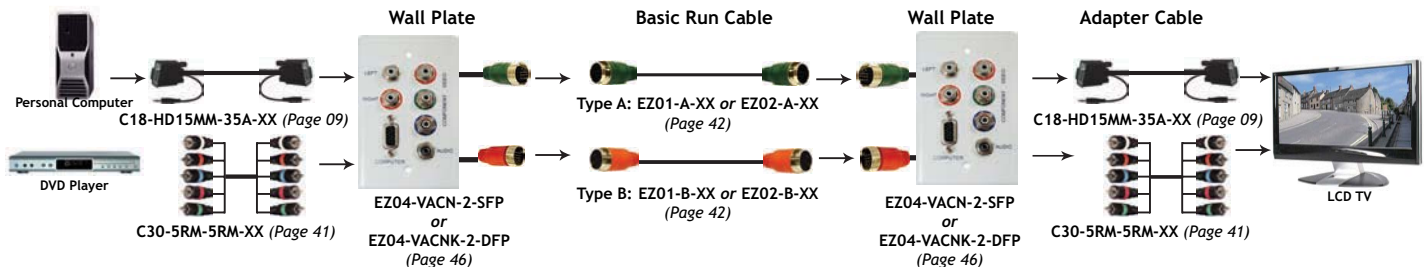

[VGA + STEREO AUDIO] + [3RCA COMPOSITE] + [S-VIDEO] SOLUTION

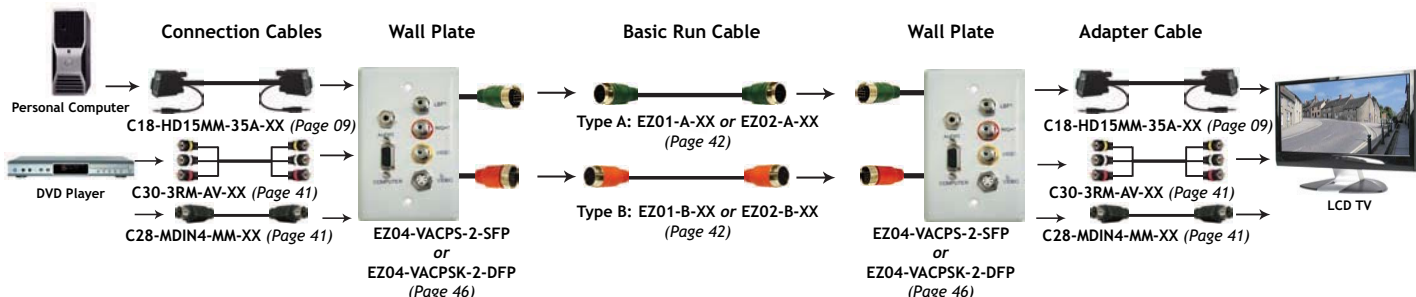

EZ INTEGRATED WALL PLATE

VGA, STEREO, 3RCA COMPOSITE SOLUTION 1

SINGLE GANG WALL PLATE

- HD15 Female, 3.5mm Stereo, Composite Video/ Audio with 1 Fly Lead, Single Gang Wall Plate

ORDER CODE	1-24	25-49	50+
EZ04-VACP-1-SFP	\$20.38	19.45	18.06



DOUBLE GANG WALL PLATE

- HD15 Female, 3.5mm Stereo, Composite Video/ Audio, 4 Keystone Jack Cutouts with 1 Fly Lead, Double Gang Wall Plate

ORDER CODE	1-24	25-49	50+
EZ04-VACPK-1-DFP	\$22.07	21.07	19.56



VGA, STEREO, 3RCA COMPOSITE SOLUTION 2

SINGLE GANG WALL PLATE

- HD15 Female, 3.5mm Stereo, Composite Video/ Audio with 2 Fly Leads, Single Gang Wall Plate

ORDER CODE	1-24	25-49	50+
EZ04-VACP-2-SFP	\$23.44	22.38	20.78



- Din14 Male (Type A) to HD15 Female, RCA Female/Composite Video, Single Gang Wall Plate

ORDER CODE	1-24	25-49	50+
EZ04-VR-1-SFP	\$11.62	11.09	10.30



- Din14 Male (Type B) to 3.5mm Jack, 2RCA Female Stereo Audio, Single Gang Wall Plate

ORDER CODE	1-24	25-49	50+
EZ04-A2R-1-SFP	\$16.58	15.83	14.70



DOUBLE GANG WALL PLATE

- HD15 Female, 3.5mm Stereo, Composite Video/ Audio, 4 Keystone Jack Cutouts with 2 Fly Leads, Double Gang Wall Plate

ORDER CODE	1-24	25-49	50+
EZ04-VACPK-2-DFP	\$26.19	25.00	23.21



VGA, STEREO, 5RCA SOLUTION

SINGLE GANG WALL PLATE

- HD15 Female, 3.5mm Stereo, Component Video with 2 Fly Leads, Single Gang Wall Plate

ORDER CODE	1-24	25-49	50+
EZ04-VACN-2-SFP	\$31.89	30.44	28.27



DOUBLE GANG WALL PLATE

- HD15 Female, 3.5mm Stereo, Component Video, 4 Keystone Jack Cutouts with 2 Fly Leads, Double Gang Wall Plate

ORDER CODE	1-24	25-49	50+
EZ04-VACNK-2-DFP	\$27.98	26.71	24.80



VGA, STEREO, 3RCA COMPOSITE, S-VIDEO SOLUTION

SINGLE GANG WALL PLATE

- HD15 Female, 3.5mm stereo, Composite Video/ Audio, S-Video with 2 Fly Leads, Single Gang Wall Plate

ORDER CODE	1-24	25-49	50+
EZ04-VACPS-2-SFP	\$31.79	30.34	28.17



DOUBLE GANG WALL PLATE

- HD15 Female, 3.5mm Stereo, Composite Video/ Audio, S-Video, 4 Keystone Jack Cutouts with 2 Fly Leads, Double Gang Wall Plate

ORDER CODE	1-24	25-49	50+
EZ04-VACPSK-2-DFP	\$34.32	32.76	30.42



EZ INTEGRATED ADAPTER CABLE

VGA, STEREO, 3RCA COMPOSITE SOLUTION 1

- Din14 (Type A) Male to HD15 Male, Composite Video/Audio Male Adapter Cable

ORDER CODE	LENGTH	1-24	25-49	50+
EZ03-VACP-1-1.5	1.5 feet	\$13.73	13.10	12.17
EZ03-VACP-1-03	3 feet	15.49	14.78	13.73
EZ03-VACP-1-06	6 feet	19.27	18.40	17.08
EZ03-VACP-1-10	10 feet	24.29	23.18	21.53



EZ03-VACP-1-XX

VGA, STEREO, 3RCA COMPOSITE SOLUTION 2

SOLD AS A SET OF EZ03-VR-1 (Din14 (Type A) Male to HD15 Male, Composite Video/Audio Male Adapter Cable) and EZ03-A2R-1 (Din14 (Type B) Male to 3.5mm, 2 RCA (Stereo Audio - White & Red) Adapter Cable)

ORDER CODE	LENGTH	1-24	25-49	50+
EZ03-VACP-2-1.5	1.5 feet	\$14.68	14.01	13.01
EZ03-VACP-2-03	3 feet	17.25	16.46	15.29
EZ03-VACP-2-06	6 feet	22.44	21.42	19.89
EZ03-VACP-2-10	10 feet	29.30	27.97	25.97



EZ03-VR-1



EZ03-A2R-1

OTHER WALL PLATE



EZ04-HDMI-FF-PT



071D-DVI-FP



071D-HD15-FP



071D-DVI-35A-FP



071D-HD15-35A-FP

ORDER CODE	DESCRIPTION	1-24	25-49	50+
EZ04-HDMI-FF-PT	HDMI F Snap-in Module to HDMI F Wall Plate	\$9.68	9.24	8.58
071D-DVI-FP	DVI F to DVI F Wall Plate	8.71	8.32	7.72
071D-HD15-FP	HD15 F to HD15 F Wall Plate	6.95	6.64	6.16
071D-DVI-35A-FP	DVI F to DVI F with Audio Wall Plate	10.47	10.00	9.28
071D-HD15-35A-FP	HD15 F to HD15 F with Audio Wall Plate	8.71	8.32	7.72

SCREWLESS MOUNTING BOX & WALL PLATE



071D-BOX-WH



* Screwless Wall Plate is sold separately.

SCREWLESS MOUNTING BOX

- Screws are not shown for elegant appearance.
- Color: White.
- Dimension: 81.5mm x 126.5mm x 54mm.

ORDER CODE	1-24	25-49	50+
071D-BOX-WH	\$4.14	3.95	3.67

SCREWLESS WALL PLATE



ORDER CODE	DESCRIPTION	1-24	25-49	50+
07Y-100-WH	Blank Insert for Single Gang Screwless Wall Plate, White	\$1.76	1.68	1.56
07Y-101-WH	1 Cutout for Single Gang Screwless Wall Plate, White	1.76	1.68	1.56
07Y-102-WH	2 Cutouts for Single Gang Screwless Wall Plate, White	1.76	1.68	1.56
07Y-103-WH	3 Cutouts for Single Gang Screwless Wall Plate, White	1.76	1.68	1.56
07Y-104-WH	4 Cutouts for Single Gang Screwless Wall Plate, White	1.76	1.68	1.56
07Y-106-WH	6 Cutouts for Single Gang Screwless Wall Plate, White	1.76	1.68	1.56
07Y-120-WH	Blank Insert for Double Gang Screwless Wall Plate, White	3.52	3.36	3.12
07Y-121-WH	2x1 Cutouts for Double Gang Screwless Wall Plate, White	3.52	3.36	3.12
07Y-122-WH	2x2 Cutouts for Double Gang Screwless Wall Plate, White	3.52	3.36	3.12
07Y-123-WH	2x3 Cutouts for Double Gang Screwless Wall Plate, White	3.52	3.36	3.12
07Y-124-WH	2x4 Cutouts for Double Gang Screwless Wall Plate, White	3.52	3.36	3.12
07Y-126-WH	2x6 Cutouts for Double Gang Screwless Wall Plate, White	3.52	3.36	3.12

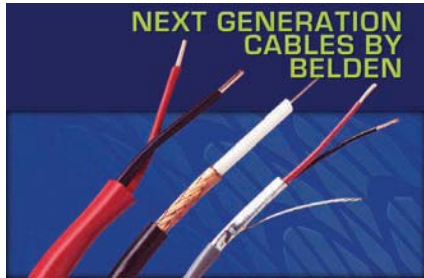

- For Residential or Commercial use.

ORDER CODE	DESCRIPTION	PRICE/1000FT
BN-1189A-WH	RG-6 Quad Shield Broadband Coaxial Cable, White color, 1000 feet	
BN-1189A-BK	RG-6 Quad Shield Broadband Coaxial Cable, Black color, 1000 feet	
BN-9116-BK	RG-6 Duobond Shield Broadband Coaxial Cable, Black color, 1000 feet	
BN-543945	New Generation RG-59 Security Coaxial Cable, CCTV Usage, 1000 feet	
BN-549945	New Generation RG-59 Security Composite Cable, CCTV Plus Audio Applications, 1000 feet	
BN-5300UG	New Generation Security and Alarm Cable, Residential, Light Commercial Applications, 1000 feet	
BN-5339B5	New Generation RG-6 Duofoil Shield Security Coaxial Cable, CCTV and MATV Usage, 1000 feet	
BN-5339Q5	New Generation RG-6 Quad Shield Security Coaxial Cable, CCTV Usage, 1000 feet	
BN-5500UE	New Generation Security and Alarm Cable, Commercial Applications, 2 conductors, 1000 feet	
BN-5502UE	New Generation Security and Alarm Cable, Commercial Applications, 4 conductors, 1000 feet	

PLEASE CALL FOR PRICE

BELDEN 3GHz HIGH FLEXIBLE VIDEO PATCH CABLES

- Cable : Belden 1505F RG59/RG6 broadband coax.
- Hi-Flex cable construction replaces traditional stiff and rigid video cables.
- Stranded center conductor and 94% tinned braid shielded structure - very flexible for video patching application at home, or broadcasting industry.
- Injection molded strain relief on connectorized ends.
- High performance rating, up to 3 GHz stability.
- Corrosion-resistant 24K gold plated center pin.
- Available in 6 colors.



PATCH CABLES WITH F CONNECTORS

- Connectors : 3 styles of F connectors - 180° Threaded Type, easy snap-in Push-On Type, and 90° Threaded Type.



PATCH CABLES WITH BNC CONNECTORS

- Connectors : BNC male connectors.

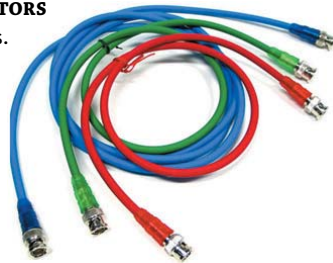

ORDER CODE	DESCRIPTION	1-49	50-99	100+
H50-BB-11-TT-01-XX	BNC Male to BNC Male cable, 1 foot	\$6.07	5.80	5.38
H50-BB-11-TT-03-XX	BNC Male to BNC Male cable, 3 feet	7.66	7.31	6.79
H50-BB-11-TT-06-XX	BNC Male to BNC Male cable, 6 feet	10.03	9.58	8.89
H50-BB-11-TT-10-XX	BNC Male to BNC Male cable, 10 feet	13.20	12.60	11.70

• Custom Length: \$5.50 + \$0.80/ft.



ORDER CODE	DESCRIPTION	1-49	50-99	100+
H50-FF-11-TT-01-XX	Threaded 180° Male to 180° Male, 1 foot	\$6.07	5.80	5.38
H50-FF-11-TT-03-XX	Threaded 180° Male to 180° Male, 3 feet	7.66	7.31	6.79
H50-FF-11-TT-06-XX	Threaded 180° Male to 180° Male, 6 feet	10.03	9.58	8.89
H50-FF-11-TT-10-XX	Threaded 180° Male to 180° Male, 10 feet	13.20	12.60	11.70
H50-FF-11-PP-01-XX	Push-On 180° Male to 180° Male, 1 foot	6.07	5.80	5.38
H50-FF-11-PP-03-XX	Push-On 180° Male to 180° Male, 3 feet	7.66	7.31	6.79
H50-FF-11-PP-06-XX	Push-On 180° Male to 180° Male, 6 feet	10.03	9.58	8.89
H50-FF-11-PP-10-XX	Push-On 180° Male to 180° Male, 10 feet	13.20	12.60	11.70
H50-FF-99-TT-01-XX	Threaded 90° Male to 90° Male, 1 foot	6.07	5.80	5.38
H50-FF-99-TT-03-XX	Threaded 90° Male to 90° Male, 3 feet	7.66	7.31	6.79
H50-FF-99-TT-06-XX	Threaded 90° Male to 90° Male, 6 feet	10.03	9.58	8.89
H50-FF-99-TT-10-XX	Threaded 90° Male to 90° Male, 10 feet	13.20	12.60	11.70

• Custom Length: \$5.50 + \$0.80/ft.



PREMIUM RG-59 75 OHM COAX CABLES

BNC MALE TO BNC MALE, GOLD CONNECTOR

- Cable: RG-59 B/U.
- Conductor: 1/0.58 Bare Copper + PE Insulation + Braid (16*7/0.12), PVC Jacket.
- Connectors: BNC Male, gold flash contact.
- Insulator: 75 Ohm white gold plated shell.
- Assembly Boot: 45P PVC black, molded.



ORDER CODE	LENGTH	1-49	50-99	100+
C33-BNC-MM-03	3 feet	\$4.93	4.70	4.37
C33-BNC-MM-06	6 feet	5.63	5.38	4.99
C33-BNC-MM-10	10 feet	6.69	6.38	5.93
C33-BNC-MM-15	15 feet	8.71	8.32	7.72
C33-BNC-MM-25	25 feet	10.74	10.25	9.52

• Custom Length: Please Call for Price.

F CONNECTOR MALE TO F CONNECTOR MALE (PUSH-ON TYPE)

- Cable: RG-59 B/U.
- Conductor: 1/0.58 Bare Copper + PE Insulation + Braid (16*7/0.12), PVC Jacket.
- Connectors: F Connectors Male, gold flash contact.
- Insulator: White gold plated shell (180° RG59U Push-On Type).
- Assembly Boot: 45P PVC black, molded.



ORDER CODE	LENGTH	1-49	50-99	100+
C34-FP-MM-03	3 feet	\$3.34	3.19	2.96
C34-FP-MM-06	6 feet	4.05	3.86	3.59
C34-FP-MM-10	10 feet	5.19	4.96	4.60
C34-FP-MM-15	15 feet	6.51	6.22	5.77
C34-FP-MM-25	25 feet	9.15	8.74	8.11

• Custom Length: Please Call for Price.

F CONNECTOR MALE TO F CONNECTOR MALE (SCREWED TYPE)

- Cable: RG-59 B/U.
- Conductor: 1/0.58 Bare Copper + PE Insulation + Braid (16*7/0.12), PVC Jacket.
- Connectors: F Connectors Male, gold flash contact.
- Insulator: White gold plated shell (180° RG59U Screwed Type).
- Assembly Boot: 45P PVC black, molded.



ORDER CODE	LENGTH	1-49	50-99	100+
C34-FM-MM-03	3 feet	\$3.34	3.19	2.96
C34-FM-MM-06	6 feet	4.05	3.86	3.59
C34-FM-MM-10	10 feet	5.19	4.96	4.60
C34-FM-MM-15	15 feet	6.51	6.22	5.77
C34-FM-MM-25	25 feet	9.15	8.74	8.11

• Custom Length: Please Call for Price.

SVGA & VGA CABLES

CMP PLENUM SVGA CABLE

- 28 AWG, spiral shielded coax, 75 Ohm UL1354, aluminum foil and braid shielded with drain wire.
- HD D-sub 15-pin Male, solder type, gold/silver flash contacts and thumb screws molded.
- Hoods molded black, CMP PVC.



ORDER CODE	DESCRIPTION	PRICE
C18P-HD15MM-50	CMP Plenum HD15 Male to Male, 50 feet	PLEASE CALL FOR PRICE
C18P-HD15MM-75	CMP Plenum HD15 Male to Male, 75 feet	
C18P-HD15MM-100	CMP Plenum HD15 Male to Male, 100 feet	
C18P-HD15MM,MF,FF-XX	CMP Plenum HD15 Male/Female, Custom Length	

ENHANCED VGA MONITOR CABLE

- Extends cable range to up to 100 feet.
- 3 mini coaxial conductors, 2 pairs of individual shielded conductors under one jacket - extends signal integrity.



ORDER CODE	DESCRIPTION	1-24	25-49	50+
C18-HD15MM-03	Male/Male, 3 feet	\$4.58	4.37	4.06
C18-HD15MM-06	Male/Male, 6 feet	6.69	6.38	5.93
C18-HD15MM-10	Male/Male, 10 feet	9.68	9.24	8.58
C18-HD15MM-15	Male/Male, 15 feet	13.20	12.60	11.70
C18-HD15MM-25	Male/Male, 25 feet	20.24	19.32	17.94
C18-HD15MM-50	Male/Male, 50 feet	36.96	35.28	32.76
C18-HD15MM-75	Male/Male, 75 feet	54.56	52.08	48.36
C18-HD15MM-100	Male/Male, 100 feet	70.40	67.20	62.40
C18-HD15MF-03	Male/Female, 3 feet	4.58	4.37	4.06
C18-HD15MF-06	Male/Female, 6 feet	6.69	6.38	5.93
C18-HD15MF-10	Male/Female, 10 feet	9.68	9.24	8.58
C18-HD15MF-15	Male/Female, 15 feet	13.20	12.60	11.70
C18-HD15MF-25	Male/Female, 25 feet	20.24	19.32	17.94
C18-HD15MF-50	Male/Female, 50 feet	36.96	35.28	32.76
C18-HD15MF-75	Male/Female, 75 feet	54.56	52.08	48.36
C18-HD15MF-100	Male/Female, 100 feet	70.40	67.20	62.40

VIDEO Y CABLE & ANGLE SVGA CABLE

- SVGA cables : 90° male, left or right exit, to 180° male.
- Video Y cable : Splitter cable, HD15 male to 2 x HD15 female, 8 inches.



ORDER CODE	DESCRIPTION	1-24	25-49	50+
C18-HD15MM-06L	SVGA Cable, Left Exit, 6 feet	\$12.76	12.18	11.31
C18-HD15MM-10L	SVGA Cable, Left Exit, 10 feet	17.60	16.80	15.60
C18-HD15MM-06R	SVGA Cable, Right Exit, 6 feet	12.76	12.18	11.31
C18-HD15MM-10R	SVGA Cable, Right Exit, 10 feet	17.60	16.80	15.60
C18-Y-MFF-008	VGA Y Splitter Cable, 8 inches	4.05	3.86	3.59



SVGA + 3.5MM AUDIO MALE TO MALE

- VGA Connectors: HD15 Male to HD15 Male
- Audio Connectors: 3.5mm Male to 3.5mm Male

ORDER CODE	DESCRIPTION	1-24	25-49	50+
C18-HD15M-35A-03	SVGA+3.5mm Audio Male to Male, 3 feet	\$5.21	4.67	4.62
C18-HD15M-35A-06	SVGA+3.5mm Audio Male to Male, 6 feet	7.30	6.97	6.47
C18-HD15M-35A-10	SVGA+3.5mm Audio Male to Male, 10 feet	10.12	9.66	8.97
C18-HD15M-35A-15	SVGA+3.5mm Audio Male to Male, 15 feet	13.64	13.02	12.09



BNC VIDEO CABLES

HIGH DENSITY DB-15 VGA TO 5 BNC CABLE

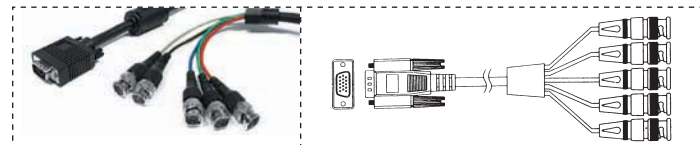

ORDER CODE	DESCRIPTION	1-24	25-49	50+
E05-HD15M-5BNCM-1	HD DB-15 Male to 5 Male BNC, 1 foot	\$14.08	13.44	12.48
E05-HD15M-5BNCF-1	HD DB-15 Male to 5 Female BNC, 1 foot	14.08	13.44	12.48
E05-HD15F-5BNCM-1	HD DB-15 Female to 5 Male BNC, 1 foot	14.08	13.44	12.48
E05-HD15F-5BNCF-1	HD DB-15 Female to 5 Female BNC, 1 foot	14.08	13.44	12.48
E06-HD15M-5BNCM-6	HD DB-15 Male to 5 Male BNC, 6 feet with Ferrie Cord	15.84	15.12	14.04
E06-HD15M-5BNCM-10	HD DB-15 Male to 5 Male BNC, 10 feet with Ferrie Cord	21.12	20.16	18.72

DB-15 TO 5 BNC CABLE (FOR MAC)

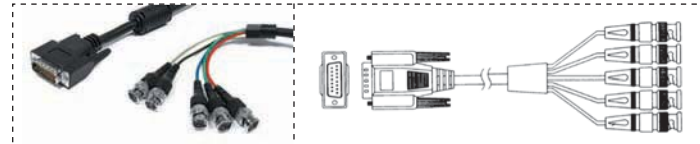

ORDER CODE	DESCRIPTION	1-24	25-49	50+
E07-D15M-5BNCM-6	DB-15 Male to 5 BNC Male, 6 feet	\$19.36	18.48	17.16

4 TO 4, OR 5 TO 5 BNC MALE CABLE

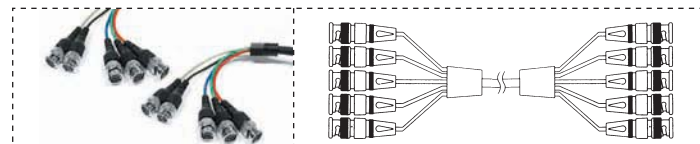

ORDER CODE	DESCRIPTION	1-24	25-49	50+
E07-4BNCM-4BNCM-06	4 BNC Male to 4 BNC Male, 6 feet	\$24.64	23.52	21.84
E07-4BNCM-4BNCM-10	4 BNC Male to 4 BNC Male, 10 feet	28.16	26.88	24.96
E07-4BNCM-4BNCM-25	4 BNC Male to 4 BNC Male, 25 feet	45.76	43.68	40.56
E07-5BNCM-5BNCM-06	5 BNC Male to 5 BNC Male, 6 feet	28.16	26.88	24.96
E07-5BNCM-5BNCM-10	5 BNC Male to 5 BNC Male, 10 feet	31.68	30.24	28.08
E07-5BNCM-5BNCM-25	5 BNC Male to 5 BNC Male, 25 feet	51.04	48.72	45.24

IEEE 1394B FIREWIRE

IEEE 1394B FIREWIRE - 9 POSITION CONNECTOR RELATED CABLES

- Connectors: 9-pin Male to 4-pin Male / 6-pin Male / 9-pin Male.
- Supports data transfer rates up to 400 Mbps.
- Compatible: Connectors FireWire 800 devices to legacy 1394a ports.
- IEEE Standard 1394b compliant.
- Plug-and-play operation.

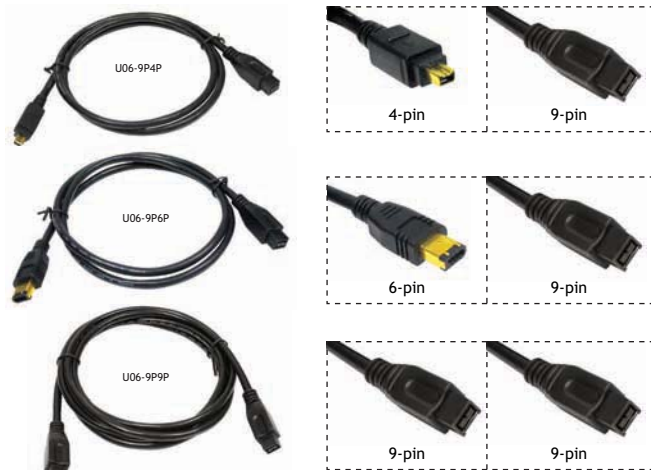

ORDER CODE	DESCRIPTION	1-24	25-49	50+
U06-9P4P-06	1394 FireWire, 9-pin Male to 4-pin Male, 6 ft	\$8.36	7.98	7.41
U06-9P4P-10	1394 FireWire, 9-pin Male to 4-pin Male, 10 ft	10.74	10.25	9.52
U06-9P6P-06	1394 FireWire, 9-pin Male to 6-pin Male, 6 ft	7.13	6.80	6.32
U06-9P6P-10	1394 FireWire, 9-pin Male to 6-pin Male, 10 ft	8.80	8.40	7.80
U06-9P9P-06	1394 FireWire, 9-pin Male to 9-pin Male, 6 ft	9.77	9.32	8.66
U06-9P9P-10	1394 FireWire, 9-pin Male to 9-pin Male, 10 ft	11.44	10.92	10.14

IEEE 1394A FIREWIRE

IEEE 1394A FIREWIRE - 6 POSITION CONNECTOR RELATED CABLES

- Provides high performance IEEE bus interface between PC and Peripheral and consumer electronic products.
- Data transfer rate: between 100Mbps and 400Mbps.
- Plug-and-play and hot-swapping capabilities.
- Maximum chaining devices: 67.



ORDER CODE	DESCRIPTION	1-24	25-49	50+
U06-4P4P-06	4 pin to 4 pin, 6 feet	\$4.58	4.37	4.06
U06-4P4P-10	4 pin to 4 pin, 10 feet	7.39	7.06	6.55
U06-6P4P-06	6 pin to 4 pin, 3 feet	3.52	3.36	3.12
U06-6P4P-03	6 pin to 4 pin, 6 feet	4.58	4.37	4.06
U06-6P4P-10	6 pin to 4 pin, 10 feet	7.39	7.06	6.55
U06-6P4P-15	6 pin to 4 pin, 15 feet	10.03	9.58	8.89
U06-6P6P-03	6 pin to 6 pin, 3 feet	4.22	4.03	3.74
U06-6P6P-06	6 pin to 6 pin, 6 feet	5.10	4.87	4.52
U06-6P6P-10	6 pin to 6 pin, 10 feet	7.39	7.06	6.55
U06-6P6P-15	6 pin to 6 pin, 15 feet	10.03	9.58	8.89

IEEE 1284 BI-DIRECTIONAL HIGH SPEED PRINTER CABLES

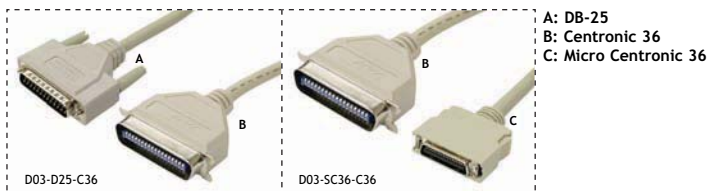

ORDER CODE	DESCRIPTION	1-24	25-49	50+
D03-D25-C36	DB-25 Male to DB-25 Male, 6 feet	\$6.81	6.50	6.04
D03-D25-D25-10	DB-25 Male to DB-25 Male, 10 feet	9.77	9.32	8.66
D03-D25-D25-15	DB-25 Male to DB-25 Male, 15 feet	13.38	12.77	11.86
D03-D25-D25-25	DB-25 Male to DB-25 Male, 25 feet	20.59	19.66	18.25
D03-D25-MF-06	DB-25 Male to DB-25 Female, 6 feet	6.81	6.50	6.04
D03-D25-MF-10	DB-25 Male to DB-25 Female, 10 feet	9.77	9.32	8.66
D03-D25-MF-15	DB-25 Male to DB-25 Female, 15 feet	13.38	12.77	11.86
D03-D25-C36-03	DB-25 to Centronics 36, 3 feet	4.66	4.45	4.13
D03-D25-C36-06	DB-25 to Centronics 36, 6 feet	6.86	6.55	6.08
D03-D25-C36-10	DB-25 to Centronics 36, 10 feet	9.68	9.24	8.58
D03-D25-C36-15	DB-25 to Centronics 36, 15 feet	13.38	12.77	11.86
D03-D25-C36-25	DB-25 to Centronics 36, 25 feet	20.59	19.66	18.25
D03-D25-C36-50	DB-25 to Centronics 36, 50 feet	38.54	36.79	34.16
D03-SC36-C36-06	Centronics 36 (micro) to Centronics 36, 6 feet	8.71	8.32	7.72
D03-SC36-C36-10	Centronics 36 (micro) to Centronics 36, 10 feet	11.62	11.09	10.30
D03-SC36-D25-03	Centronics 36 (micro) to DB-25, 3 feet	6.42	6.13	5.69
D03-SC36-D25-06	Centronics 36 (micro) to DB-25, 6 feet	8.62	8.23	7.64
D03-SC36-D25-10	Centronics 36 (micro) to DB-25, 10 feet	11.53	11.00	10.22
D03-SC36-SC36-06	Centronics 36 (micro) Both Sides, 6 feet	13.20	12.60	11.70
D03-SC36-SC36-10	Centronics 36 (micro) Both Sides, 10 feet	15.22	14.53	13.49

HP PLOTTER / LASER SERIAL PRINTER CABLE

ORDER CODE	DESCRIPTION	1-24	25-49	50+
C24-25M-09F-06	DB-25 Male to DB-9 Female, 6 feet	\$2.82	2.69	2.50
C24-25M-09F-10	DB-25 Male to DB-9 Female, 10 feet	3.52	3.36	3.12
C24-25M-09F-25	DB-25 Male to DB-9 Female, 25 feet	6.68	6.55	6.08
C24-25M-25F-06	DB-25 Male to DB-25 Female, 6 feet	2.82	2.69	2.50
C24-25M-25F-10	DB-25 Male to DB-25 Female, 10 feet	3.52	3.36	3.12
C24-25M-25F-25	DB-25 Male to DB-25 Female, 25 feet	6.86	6.55	6.08

DB-9 SERIAL CABLE

AT SERIAL / MONOCHROME MONITOR CABLE (DB-9)

- 28 AWG foil shield construction.
- Fully molded hoods with thumbscrews.



ORDER CODE	DESCRIPTION	1-24	25-49	50+
C06-9M-9F-06	DB-9 Male to Female, 6 feet	\$2.73	2.60	2.42
C06-9M-9F-10	DB-9 Male to Female, 10 feet	3.52	3.36	3.12
C06-9M-9F-15	DB-9 Male to Female, 15 feet	4.49	4.28	3.98
C06-9M-9F-25	DB-9 Male to Female, 25 feet	6.51	6.22	5.77
C06-9M-9M-06	DB-9 Male to Male, 6 feet	2.73	2.60	2.42
C06-9M-9M-10	DB-9 Male to Male, 10 feet	3.52	3.36	3.12
C06-9M-9M-15	DB-9 Male to Male, 15 feet	4.49	4.28	3.98
C06-9M-9M-25	DB-9 Male to Male, 25 feet	6.51	6.22	5.77
C06-9F-9F-06	DB-9 Female to Female, 6 feet	2.73	2.60	2.42
C06-9F-9F-10	DB-9 Female to Female, 10 feet	3.52	3.36	3.12

DVI SPLITTER CABLES

DVI MALE TO 2 DVI FEMALE SPLITTER CABLE

ORDER CODE	LENGTH	1-24	25-49	50+
E08-DM-2DF-01	1 Foot	\$11.62	11.09	10.30



DVI MALE TO 2 VGA (HD15) FEMALE SPLITTER CABLE

ORDER CODE	LENGTH	1-24	25-49	50+
E08-DM-2HD15F-01	1 Foot	\$8.80	8.40	7.80



DVI MALE WITH AUDIO CABLE



- DVI-D Male with 3.5mm Audio Male on both sides.

ORDER CODE	LENGTH	1-24	25-49	50+
E08-DM-DM-D-35A-06	6 feet	\$15.84	15.12	15.04
E08-DM-DM-D-35A-10	10 feet	18.04	17.22	15.99

PARALLEL PRINTER CABLES

- DB-25 Male to Centronics 36 Male, 25 conductors, Molded.
- 28 AWG foil shield construction.

ORDER CODE	DESCRIPTION	1-24	25-49	50+
C01-25M36M2503	25C, 3 feet	\$3.70	3.53	3.28
C01-25M36M2506	25C, 6 feet	4.75	4.54	4.21
C01-25M36M2510	25C, 10 feet	6.51	6.22	5.77
C01-25M36M2515	25C, 15 feet	8.54	8.15	7.57
C01-25M36M2525	25C, 25 feet	12.50	11.93	11.08
C01-25M36M2550	25C, 50 feet	22.18	21.17	19.66



CENTRONICS 36 PARALLEL CABLE

- Centronics 36 Male to Male, Male to Female, or Female to Female.
- Female with Spring Latch Type, Male with Bail Lock Type.
- Cable: 36 conductors.
- 28 AWG foil shield construction.

ORDER CODE	DESCRIPTION	1-24	25-49	50+
C05-36M36M3606	Male to Male, 6 feet	\$5.98	5.71	5.30
C05-36M36M3610	Male to Male, 10 feet	8.27	7.90	7.33
C05-36M36M3615	Male to Male, 15 feet	11.09	10.58	9.83
C05-36M36M3625	Male to Male, 25 feet	16.63	15.88	14.74
C05-36M36F3606	Male to Female, 6 feet	5.98	5.71	5.30
C05-36M36F3610	Male to Female, 10 feet	8.27	7.90	7.33
C05-36M36F3625	Male to Female, 25 feet	16.63	15.88	14.74
C05-36F36F3606	Female to Female, 6 feet	5.98	5.71	5.30
C05-36F36F3610	Female to Female, 10 feet	8.27	7.90	7.33
C05-36F36F3625	Female to Female, 25 feet	16.63	15.88	14.74

PS/2 KEYBOARD CABLE

PS/2 KEYBOARD CABLE (Mini Din 6)

ORDER CODE	DESCRIPTION	1-24	25-49	50+
C08-MD6MM-06	Male/Male, 6 feet	\$1.80	1.71	1.59
C08-MD6MM-10	Male/Male, 10 feet	2.38	2.27	2.11
C08-MD6MM-15	Male/Male, 15 feet	3.08	2.94	2.73
C08-MD6MM-25	Male/Male, 25 feet	4.66	4.45	4.13
C08-MD6MM-50	Male/Male, 50 feet	8.36	7.98	7.41
C08-MD6MM-75	Male/Male, 75 feet	14.08	13.44	12.48
C08-MD6MF-06	Male/Female, 6 feet	1.80	1.71	1.59
C08-MD6MF-10	Male/Female, 10 feet	2.38	2.27	2.11
C08-MD6MF-15	Male/Female, 15 feet	3.08	2.94	2.73
C08-MD6MF-25	Male/Female, 25 feet	4.66	4.45	4.13
C08-MD6MF-50	Male/Female, 50 feet	8.36	7.98	7.41
C08-MD6MF-75	Male/Female, 75 feet	14.08	13.44	12.48



DVI CABLES

A.

DVI-D DL (male)

ORDER CODE	DESCRIPTION	1-24	25-49	50+
E08-DM-DM-D-06	DVI-D Digital Dual Link, Male to Male, 6 feet	\$14.08	13.44	12.48
E08-DM-DM-D-10	DVI-D Digital Dual Link, Male to Male, 10 feet	16.28	15.54	14.43
E08-DM-DM-D-15	DVI-D Digital Dual Link, Male to Male, 15 feet	20.77	19.82	18.41

B.

DVI-D DL (female)

ORDER CODE	DESCRIPTION	1-24	25-49	50+
E08-DM-DF-D-06	DVI-D Digital Dual Link, Male to Female, 6 feet	\$16.72	15.96	14.82
E08-DM-DF-D-10	DVI-D Digital Dual Link, Male to Female, 10 feet	18.48	17.64	16.38
E08-DM-DF-D-15	DVI-D Digital Dual Link, Male to Female, 15 feet	22.00	21.00	19.50

C.

DVI-I (male)

ORDER CODE	DESCRIPTION	1-24	25-49	50+
E08-ADM-ADM-D-06	DVI-I Analog+Digital, Dual Link, Male to Male, 6 feet	\$16.28	15.54	14.43
E08-ADM-ADM-D-10	DVI-I Analog+Digital, Dual Link, Male to Male, 10 feet	18.48	17.64	16.38

D.

DVI-I (female)

ORDER CODE	DESCRIPTION	1-24	25-49	50+
E08-ADM-ADF-D-06	DVI-I Analog+Digital, Dual Link, Male to Female, 6 feet	\$17.25	16.46	15.29
E08-ADM-ADF-D-10	DVI-I Analog+Digital, Dual Link, Male to Female, 10 feet	21.12	20.16	18.72

E.

DVI-Analog (male)

ORDER CODE	DESCRIPTION	1-24	25-49	50+
E08-AM-HD15M-06	DVI Analog Male to HD15 Male, 6 feet	\$10.21	9.74	9.05
E08-AM-HD15M-10	DVI Analog Male to HD15 Male, 10 feet	11.97	11.42	10.61
E08-AM-HD15M-15	DVI Analog Male to HD15 Male, 15 feet	15.49	14.78	13.73

VGA HD-DB15 (male)

NULL MODEM CABLES



- Can be used for hardware flow control.
- Cross pinned wiring configuration.
- Fully molded hoods with thumbscrews.

NULL MODEM MOLDED CABLE (DB-25 / DB-25)

ORDER CODE	DESCRIPTION	1-24	25-49	50+
C09-25M-25M-06	DB-25 Male/DB-25 Male, 6 feet	\$2.82	2.69	2.50
C09-25M-25M-10	DB-25 Male/DB-25 Male, 10 feet	3.52	3.36	3.12
C09-25M-25M-15	DB-25 Male/DB-25 Male, 15 feet	4.49	4.28	3.98
C09-25M-25F-06	DB-25 Male/DB-25 Female, 6 feet	2.82	2.69	2.50
C09-25M-25F-10	DB-25 Male/DB-25 Female, 10 feet	3.52	3.36	3.12
C09-25M-25F-15	DB-25 Male/DB-25 Female, 15 feet	4.49	4.28	3.98
C09-25F-25F-06	DB-25 Female/DB-25 Female, 6 feet	2.82	2.69	2.50
C09-25F-25F-10	DB-25 Female/DB-25 Female, 10 feet	3.52	3.36	3.12

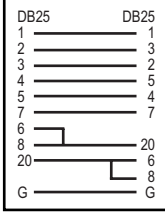

NULL MODEM MOLDED CABLE (DB-25 / DB-9)

ORDER CODE	DESCRIPTION	1-24	25-49	50+
C09-25M-09F-06	DB-25 Male/DB-9 Female, 6 feet	\$2.82	2.69	2.50
C09-25M-09F-10	DB-25 Male/DB-9 Female, 10 feet	3.52	3.36	3.12
C09-25M-09F-25	DB-25 Male/DB-9 Female, 25 feet	6.86	6.55	6.08
C09-25F-09F-06	DB-25 Female/DB-9 Female, 6 feet	2.82	2.69	2.50
C09-25F-09F-10	DB-25 Female/DB-9 Female, 10 feet	3.52	3.36	3.12

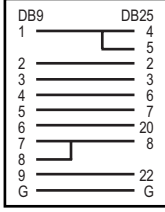

NULL MODEM MOLDED CABLE (DB-9 / DB-9)

ORDER CODE	DESCRIPTION	1-24	25-49	50+
C09-09M-09F-06	DB-9 Male/DB-9 Female, 6 feet	\$2.73	2.60	2.42
C09-09M-09F-10	DB-9 Male/DB-9 Female, 10 feet	3.52	3.36	3.12
C09-09F-09F-06	DB-9 Female/DB-9 Female, 6 feet	2.73	2.60	2.42
C09-09F-09F-10	DB-9 Female/DB-9 Female, 10 feet	3.52	3.36	3.12

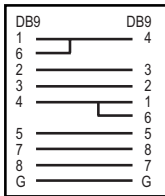

SPEAKER CABLES



ORDER CODE	DESCRIPTION	1-24	25-49	50+
C27-SM-2RM-03	3.5mm Stereo Plug to 2 RCA Male, 3 feet	\$2.02	1.93	1.79
C27-SM-2RM-06	3.5mm Stereo Plug to 2 RCA Male, 6 feet	2.46	2.35	2.18
C27-SM-2RM-10	3.5mm Stereo Plug to 2 RCA Male, 10 feet	3.17	3.02	2.81
C27-SM-2RM-15	3.5mm Stereo Plug to 2 RCA Male, 15 feet	3.87	3.70	3.43
C27-SM-2RM-25	3.5mm Stereo Plug to 2 RCA Male, 25 feet	5.46	5.21	4.84
C27-RM-RM-03	RCA Male to Male Cable, 3 feet	0.88	0.84	0.78
C27-RM-RM-06	RCA Male to Male Cable, 6 feet	1.14	1.09	1.01
C27-RM-RM-10	RCA Male to Male Cable, 10 feet	1.50	1.43	1.33
C27-RM-RM-15	RCA Male to Male Cable, 15 feet	1.94	1.85	1.72
C27-RM-RM-25	RCA Male to Male Cable, 25 feet	2.73	2.60	2.42
C27-2RM-2RM-03	2 RCA Male to 2 RCA Male Cable, 3 feet	2.02	1.93	1.79
C27-2RM-2RM-06	2 RCA Male to 2 RCA Male Cable, 6 feet	2.46	2.35	2.18
C27-2RM-2RM-10	2 RCA Male to 2 RCA Male Cable, 10 feet	3.17	3.02	2.81
C27-2RM-2RM-15	2 RCA Male to 2 RCA Male Cable, 15 feet	3.87	3.70	3.43
C27-2RM-2RM-25	2 RCA Male to 2 RCA Male Cable, 25 feet	5.46	5.21	4.84
C27-SM-SF-03	3.5mm Stereo Plug to Jack Cable, 3 feet	1.67	1.60	1.48
C27-SM-SF-06	3.5mm Stereo Plug to Jack Cable, 6 feet	2.02	1.93	1.79
C27-SM-SF-10	3.5mm Stereo Plug to Jack Cable, 10 feet	2.46	2.35	2.18
C27-SM-SF-15	3.5mm Stereo Plug to Jack Cable, 15 feet	2.99	2.86	2.65
C27-SM-SF-25	3.5mm Stereo Plug to Jack Cable, 25 feet	4.22	4.03	3.74
C27-SM-SM-01	3.5mm Stereo Plug to Plug Cable, 1 foot	0.88	0.84	0.78
C27-SM-SM-03	3.5mm Stereo Plug to Plug Cable, 3 feet	1.67	1.60	1.48
C27-SM-SM-06	3.5mm Stereo Plug to Plug Cable, 6 feet	2.02	1.93	1.79
C27-SM-SM-10	3.5mm Stereo Plug to Plug Cable, 10 feet	2.46	2.35	2.18
C27-SM-SM-15	3.5mm Stereo Plug to Plug Cable, 15 feet	2.99	2.86	2.65
C27-SM-SM-25	3.5mm Stereo Plug to Plug Cable, 25 feet	4.22	4.03	3.74
C27-SM-2RF-03	3.5mm Stereo Plug to 2 RCA Female Cable, 3 feet	2.02	1.93	1.79
C27-SM-2RF-06	3.5mm Stereo Plug to 2 RCA Female Cable, 6 feet	2.46	2.35	2.18
C27-SM-2RF-10	3.5mm Stereo Plug to 2 RCA Female Cable, 10 feet	3.17	3.02	2.81
C27-SM-2RF-15	3.5mm Stereo Plug to 2 RCA Female Cable, 15 feet	3.87	3.70	3.43
C27-SM-2RF-25	3.5mm Stereo Plug to 2 RCA Female Cable, 25 feet	5.46	5.21	4.84
C27-2RM-2RF-03	2 RCA Male to 2 RCA Female Cable, 3 feet	2.02	1.93	1.79
C27-2RM-2RF-06	2 RCA Male to 2 RCA Female Cable, 6 feet	2.46	2.35	2.18
C27-2RM-2RF-10	2 RCA Male to 2 RCA Female Cable, 10 feet	3.17	3.02	2.81
C27-2RM-2RF-15	2 RCA Male to 2 RCA Female Cable, 15 feet	3.87	3.70	3.43
C27-2RM-2RF-25	2 RCA Male to 2 RCA Female Cable, 25 feet	5.46	5.21	4.84

SERIAL CABLES

AT SERIAL / MODEM CABLE (DB-25 / DB-9)

- 28 AWG foil shield construction.
- Fully molded hoods with thumbscrews.

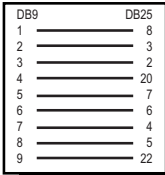

ORDER CODE	DESCRIPTION	1-24	25-49	50+
C04-25M09F0901	DB-25 Male to DB-9 Female, 1 Foot	\$2.11	2.02	1.87
C04-25M09F0903	DB-25 Male to DB-9 Female, 3 feet	2.46	2.35	2.18
C04-25M09F0906	DB-25 Male to DB-9 Female, 6 feet	3.08	2.94	2.73
C04-25M09F0910	DB-25 Male to DB-9 Female, 10 feet	3.87	3.70	3.43
C04-25M09F0915	DB-25 Male to DB-9 Female, 15 feet	4.84	4.62	4.29
C04-25M09F0925	DB-25 Male to DB-9 Female, 25 feet	6.86	6.55	6.08
C04-25M09M0903	DB-25 Male to DB-9 Male, 3 feet	2.46	2.35	2.18
C04-25M09M0906	DB-25 Male to DB-9 Male, 6 feet	3.08	2.94	2.73
C04-25M09M0910	DB-25 Male to DB-9 Male, 10 feet	3.87	3.70	3.43
C04-25M09M0925	DB-25 Male to DB-9 Male, 25 feet	6.86	6.55	6.08
C04-25F09M0901	DB-25 Female to DB-9 Male, 1 Foot	2.11	2.02	1.87
C04-25F09M0906	DB-25 Female to DB-9 Male, 6 feet	3.08	2.94	2.73
C04-25F09M0910	DB-25 Female to DB-9 Male, 10 feet	3.87	3.70	3.43

RS-232 CABLE (DB-25 / DB-25)

- DB-25 Male to Male, Male to Female or Female to Female.

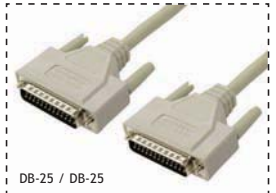

ORDER CODE	DESCRIPTION	1-24	25-49	50+
C03-25M25M2503	DB-25 Male to DB-25 Male, 3 feet	\$3.52	3.36	3.12
C03-25M25M2506	DB-25 Male to DB-25 Male, 6 feet	4.75	4.54	4.21
C03-25M25M2510	DB-25 Male to DB-25 Male, 10 feet	6.25	5.96	5.54
C03-25M25M2515	DB-25 Male to DB-25 Male, 15 feet	8.36	7.98	7.41
C03-25M25M2525	DB-25 Male to DB-25 Male, 25 feet	12.14	11.59	10.76
C03-25M25F2503	DB-25 Male to DB-25 Female, 3 feet	3.52	3.36	3.12
C03-25M25F2506	DB-25 Male to DB-25 Female, 6 feet	4.75	4.54	4.21
C03-25M25F2510	DB-25 Male to DB-25 Female, 10 feet	6.25	5.96	5.54
C03-25M25F2515	DB-25 Male to DB-25 Female, 15 feet	8.36	7.98	7.41
C03-25M25F2525	DB-25 Male to DB-25 Female, 25 feet	12.14	11.59	10.76
C03-25M25F2550	DB-25 Male to DB-25 Female, 50 feet	21.82	20.83	19.34
C03-25F25F2503	DB-25 Female to DB-25 Female, 3 feet	3.52	3.36	3.12
C03-25F25F2506	DB-25 Female to DB-25 Female, 6 feet	4.75	4.54	4.21
C03-25F25F2510	DB-25 Female to DB-25 Female, 10 feet	6.25	5.96	5.54
C03-25F25F2515	DB-25 Female to DB-25 Female, 15 feet	8.36	7.98	7.41
C03-25F25F2525	DB-25 Female to DB-25 Female, 25 feet	12.14	11.59	10.76
C03-25F25F2550	DB-25 Female to DB-25 Female, 50 feet	21.82	20.83	19.34
C03-25F25F25100	DB-25 Female to DB-25 Female, 100 feet	41.54	39.65	36.82
C03-25F25F2506	DB-25 Female to DB-25 Female, 6 feet	4.75	4.54	4.21
C03-25F25F2510	DB-25 Female to DB-25 Female, 10 feet	6.25	5.96	5.54
C03-25F25F2515	DB-25 Female to DB-25 Female, 15 feet	8.36	7.98	7.41
C03-25F25F2525	DB-25 Female to DB-25 Female, 25 feet	12.14	11.59	10.76

RS-449 SERIAL CABLE (DB-37 / DB-37)

- Fully molded hoods with thumbscrews.
- 28 AWG foil shield construction.



ORDER CODE	DESCRIPTION	UNIT PRICE
C21-37M37M3703	DB-37 Male to DB-37 Male, 3 feet	
C21-37M37M3706	DB-37 Male to DB-37 Male, 6 feet	
C21-37M37M3710	DB-37 Male to DB-37 Male, 10 feet	
C21-37M37F3703	DB-37 Male to DB-37 Female, 3 feet	
C21-37M37F3706	DB-37 Male to DB-37 Female, 6 feet	
C21-37M37F3710	DB-37 Male to DB-37 Female, 10 feet	

PLEASE CALL FOR PRICE

INTERFACE CABLES

IEEE-488, GPIB/HP-IB INTERFACE CABLE

- Centronics 24 Male + Female to Centronics 24 Male + Female.
- Metal Hood, Metric Jackscrews.

ORDER CODE	LENGTH	1-24	25-49	50+
C20-C24MF-1M	1 Meter	\$30.80	29.40	27.30
C20-C24MF-2M	2 Meters	35.20	33.60	31.20
C20-C24MF-4M	4 Meters	39.60	37.80	35.10
C20-C24MF-5M	5 Meters	46.20	44.10	40.95
C20-C24MF-8M	8 Meters	57.73	55.10	51.17

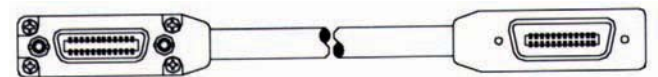

S-ATA CABLE

S-ATA (SERIAL ATA) CABLE

- Cables only 8mm O.D. - increases airflows.
- Improved signal integrity - signal to ground (1 to 1) ratio.
- Supports upto 150MB/sec data transfer.
- Cables : 26 AWG, 4 pair, shielded with 28AWG drain wire.
- Connectors : Serial ATA 7 Pin.



ORDER CODE	DESCRIPTION	1-49	50-99	100+
D21-SATA-180-18	SATA cable, single device, 18" long	\$2.20	2.10	1.95
D21-SATA-180-36	SATA cable, single device, 36" long	2.82	2.69	2.50
D21-SATA-90-18	SATA cable, single device, 18" long 90° connectors	2.20	2.10	1.95
D21-SATA-90-36	SATA cable, single device, 36" long 90° connectors	2.82	2.69	2.50

S-ATA (SERIAL ATA) POWER CONVERTER CABLE

- Used for powering serial drives.
- Converts Serial ATA drives which have a special 15 Pin Power connector to the standard 4 Pin used on most power supplies.
- Required for all Serial ATA Devices.
- Cables : UL1007 VW-1 80°C 300V 18 AWG.



ORDER CODE	DESCRIPTION	1-49	50-99	100+
D21-SATA-PW-1	SATA Power Cable, 6" long	\$1.85	1.76	1.64
D21-SATA-PW-2	SATA Power Y Cable, 12" long	2.90	2.77	2.57

S-ATA (SERIAL ATA) CABLE

- Cable: 26 AWG, 28 AWG drain wire, braid shielded, blue PVC jacket.
- Serial ATA 7-pin plug, crimping type, gold plated contacts with shell.
- Molded black PVC hood.
- Insulation Resistance: 100 mega ohm minimum.
- Conductance Resistance: 2 ohm maximum.



ORDER CODE	DESCRIPTION	1-49	50-99	100+
D22-ESATA-18	Serial ATA 7-Pin Plug Cable, 18 inches	\$2.90	2.77	2.57
D22-ESATA-36	Serial ATA 7-Pin Plug Cable, 36 inches	3.87	3.70	3.43

• Custom Length: **Please Call for Price.**

POWER CENTER & SURGE PROTECTION

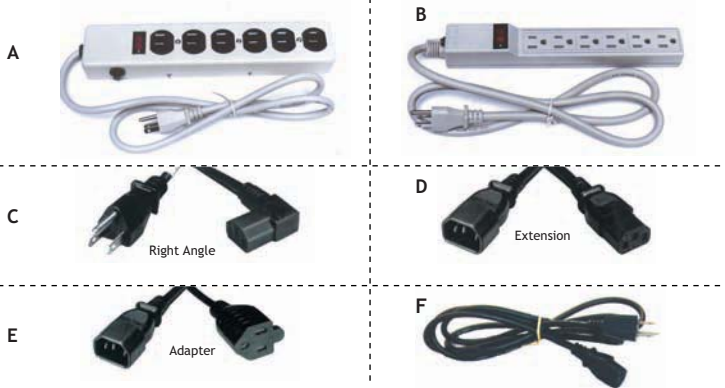

ORDER CODE	DESCRIPTION	1-24	25-49	50+
A) C15-PO-06-M	6-Outlet Power Strip, Metal Enclosure, with Surge Protection	\$9.24	8.82	8.19
B) C15-PO-06-P	6-Outlet Power Strip, Plastic Enclosure, with Surge Protection	7.48	7.14	6.63
C) C14-PC-06-RT	Power Cord, 6 feet, right angle	2.64	2.52	2.34
D) C14-EXT-06	Power Cord Extension, 6 feet	1.94	1.85	1.72
E) C14-ADP-01	Power Cord Adapter, 1 feet	1.58	1.51	1.40
C14-ADP-06	Power Cord Adapter, 6 feet	2.55	2.44	2.26
F) C14-PC-03	Power Cord, 3 feet	1.74	1.66	1.54
C14-PC-06	Power Cord, 6 feet	2.02	1.93	1.79
C14-PC-10	Power Cord, 10 feet	2.90	2.77	2.57

ESATA CABLES

SATA TO ESATA CABLE

- 18 inches

ORDER CODE	1-24	25-49	50+
D21-SATA-ESATA-18I	\$2.06	1.97	1.83

SATA TO ESATA CABLE

- 3 feet

ORDER CODE	1-24	25-49	50+
D21-SATA-ESATA-03	\$2.39	2.28	2.12

SATA TO ESATA CABLE WITH BRACKET

- 2 feet

ORDER CODE	1-24	25-49	50+
D21-SATA-ESATA-P	\$2.75	2.62	2.43

INTERNAL SAS CABLE

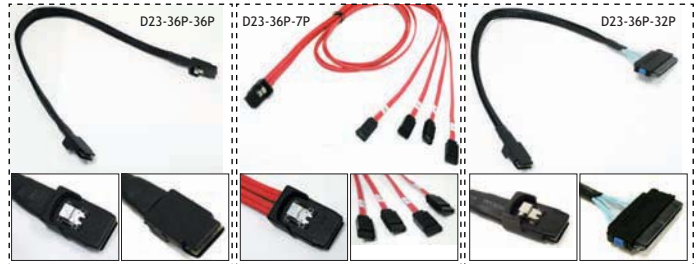

ORDER CODE	DESCRIPTION	1-24	25-49	50+
D23-36P-36P-02	Mini SAS 36P to Mini SAS 36P Cable, 18 inches	\$20.06	19.15	17.78
D23-36P-36P-03	Mini SAS 36P to Mini SAS 36P Cable, 3 feet	23.13	22.08	20.50
D23-36P-7P-02	Mini SAS 36P to 4 SATA 7P Cable, 18 inches	19.54	18.65	17.32
D23-36P-7P-03	Mini SAS 36P to 4 SATA 7P Cable, 3 feet	27.35	26.11	24.24
D23-36P-32P-02	Mini SAS 36P to SAS 32P Cable, 18 inches	19.76	18.87	17.52
D23-36P-32P-03	Mini SAS 36P to SAS 32P Cable, 3 feet	20.06	19.15	17.78

EXTERNAL SAS CABLE



ORDER CODE	DESCRIPTION	1-24	25-49	50+
D24-4X-M4X-01M	SFF 8470 to SFF 8088 Cable, 1 meter	\$48.08	45.90	42.62
D24-4X-M4X-02M	SFF 8470 to SFF 8088 Cable, 2 meters	64.22	61.30	56.92
D24-4X-M4X-03M	SFF 8470 to SFF 8088 Cable, 3 meters	80.36	76.71	71.23
D24-4X-4X-01M	SFF 8470 to SFF 8470 Cable, 1 meter	51.73	49.38	45.85
D24-4X-4X-02M	SFF 8470 to SFF 8470 Cable, 2 meters	67.85	64.76	60.14
D24-4X-4X-03M	SFF 8470 to SFF 8470 Cable, 3 meters	83.99	80.17	74.44
D24-M4X-M4X-01M	SFF 8088 to SFF 8088 Cable, 1 meter	46.46	44.35	41.18
D24-M4X-M4X-02M	SFF 8088 to SFF 8088 Cable, 2 meters	62.60	59.76	55.49
D24-M4X-M4X-03M	SFF 8088 to SFF 8088 Cable, 3 meters	78.72	75.15	69.78

INTERNAL DC POWER CABLES

POWER CABLE

- A must when adding a new drive.
- High quality components to guarantee peak performance.

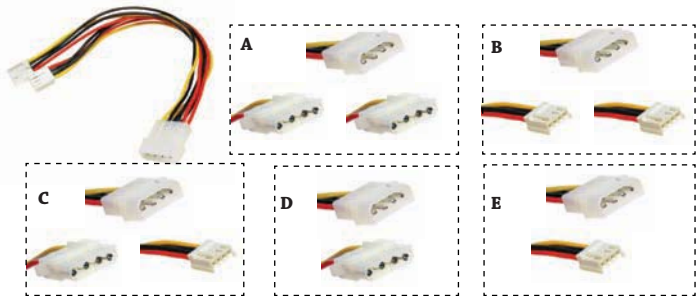

ORDER CODE	DESCRIPTION	1-24	25-49	50+
(A) C26-Y-555	5.25" Male to Two 5.25" Female, 10"	\$1.14	1.09	1.01
(B) C26-Y-533	5.25" Male to Two 3.50" Female, 10"	1.14	1.09	1.01
(C) C26-Y-553	5.25" Male to 5.25"+3.50" Female, 10"	1.14	1.09	1.01
(D) C26-5M-5F	5.25" Male to 5.25" Female, 12"	1.14	1.09	1.01
(E) C26-5M-3F	5.25" Male to 3.50" Female, 4"	1.14	1.09	1.01

GENDER CHANGERS

D-SUB MALE/MALE, FEMALE/FEMALE LOW PROFILE/MINI GENDER CHANGER & MALE/FEMALE CONNECTOR SAVER

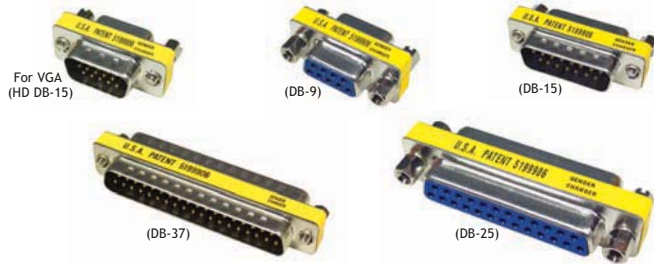

ORDER CODE	DESCRIPTION	1-24	25-49	50+
A01-09-FF	DB-9 Female to Female Gender Changer	\$1.50	1.43	1.33
A01-09-MF	DB-9 Male to Female Connector Saver	1.50	1.43	1.33
A01-09-MM	DB-9 Male to Male Gender Changer	1.50	1.43	1.33
A01-15-FF	DB-15 Female to Female Gender Changer	1.58	1.51	1.40
A01-15-MF	DB-15 Male to Female Connector Saver	1.58	1.51	1.40
A01-15-MM	DB-15 Male to Male Gender Changer	1.58	1.51	1.40
A01-25-FF	DB-25 Female to Female Gender Changer	1.67	1.60	1.48
A01-25-MF	DB-25 Male to Female Connector Saver	1.67	1.60	1.48
A01-25-MM	DB-25 Male to Male Gender Changer	1.67	1.60	1.48
A01-37-FF	DB-37 Female to Female Gender Changer	5.28	5.04	4.68
A01-37-MF	DB-37 Male to Female Connector Saver	5.28	5.04	4.68
A01-37-MM	DB-37 Male to Male Gender Changer	5.28	5.04	4.68
A01-HD15-FF	HD DB-15 (VGA) Female to Female Gender Changer	2.64	2.52	2.34
A01-HD15-MF	HD DB-15 (VGA) Male to Female Connector Saver	2.64	2.52	2.34
A01-HD15-MM	HD DB-15 (VGA) Male to Male Gender Changer	2.64	2.52	2.34

D-SUB MOLDED TYPE GENDER CHANGERS

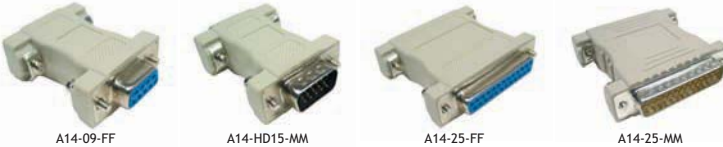

ORDER CODE	DESCRIPTION	1-24	25-49	50+
A14-09-FF	DB-9 Female to Female Gender Changer	\$1.76	1.68	1.56
A14-09-MM	DB-9 Male to Male Gender Changer	1.76	1.68	1.56
A14-25-FF	DB-25 Female to Female Gender Changer	1.76	1.68	1.56
A14-25-MM	DB-25 Male to Male Gender Changer	1.76	1.68	1.56
A14-HD15-FF	HD DB-15 (VGA) Female to Female Gender Changer	1.94	1.85	1.72
A14-HD15-MM	HD DB-15 (VGA) Male to Male Gender Changer	1.94	1.85	1.72

CENTRONICS 36, 50-PIN GENDER CHANGER



ORDER CODE	DESCRIPTION	1-24	25-49	50+
A11-36-FF	36-Pin Female to Female, Spring Latch Type	\$5.28	5.04	4.68
A11-36-MM	36-Pin Male to Male, Bail Lock Type	5.28	5.04	4.68
A11-50-FF	50-Pin Female to Female, Spring Latch Type	7.04	6.72	6.24
A11-50-MM	50-Pin Male to Male, Bail Lock Type	7.04	6.72	6.24

RS-232 TESTER

RS-232 JUMPER BOX

- DB-25 Male to Female
- Assembled.

ORDER CODE	1-24	25-49	50+
A25-DB25-MF	\$2.87	2.74	2.54



LOOP BACK TESTER & RS-232 TESTER



ORDER CODE	DESCRIPTION	1-24	25-49	50+
A26-25F09F-S	Serial Loop Back Tester, DB-25 Female to DB-9 Female, Molded	\$3.31	3.16	2.93
A26-25M-P	Parallel Loop Back Tester, DB-25 Male, One End, Molded	3.31	3.16	2.93
A26-25MF-MINI	Mini Tester, DB-25 Male to DB-25 Female, Assembled	6.60	6.30	5.85
A26-25MF-CHECK	Check Tester with Green and Red LED, DB-25 Male to DB-25 Female, Assembled	7.04	6.72	6.24

ADAPTERS

LOW PROFILE PC/AT RS-232 ADAPTER

- Slim size, save space.

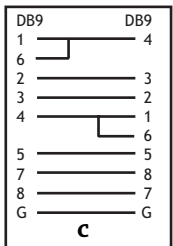
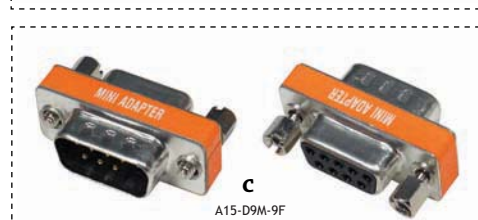
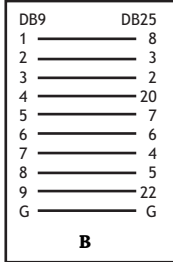
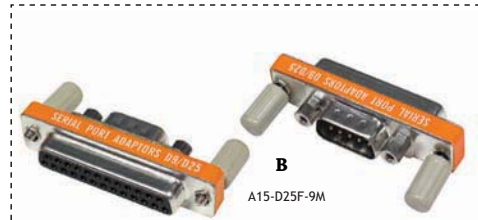
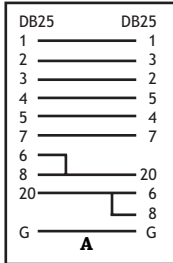
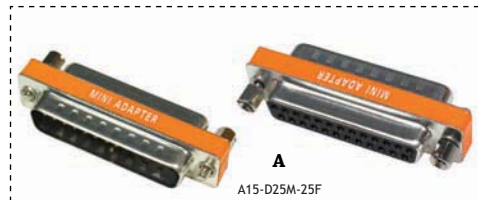

ORDER CODE	DESCRIPTION	1-24	25-49	50+
A15-D25F-9M	DB-25F to DB-9M Serial Adapter	\$2.64	2.52	2.34
A15-D25M-25F	DB-25M to DB-25F Cross-Over Adapter	2.64	2.52	2.34
A15-D9M-9F	DB-9M to DB-9F Cross Over Adapter	2.64	2.52	2.34

AT MOUSE ADAPTER DB-9 TO MINI DIN 6-PIN

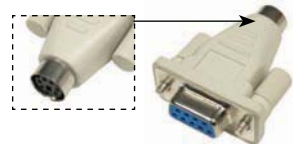

ORDER CODE	DESCRIPTION	1-24	25-49	50+
A24-D9M-MD6M	DB-9 Male / MiniDin 6 Male	\$1.43	1.36	1.26
A24-D9M-MD6F	DB-9 Male / MiniDin 6 Female	1.55	1.48	1.37
A24-D9F-MD6M	DB-9 Female / MiniDin 6 Male	1.55	1.48	1.37
A24-D9F-MD6F	DB-9 Female / MiniDin 6 Female	1.43	1.36	1.26

D-SUB 25-PIN TO D-SUB 9-PIN ADAPTER



ORDER CODE	DESCRIPTION	1-24	25-49	50+
A12-25M-9M	DB-25 Male to DB-9 Male	\$2.11	2.02	1.87
A12-25M-9F	DB-25 Male to DB-9 Female	2.11	2.02	1.87
A12-25F-9M	DB-25 Female to DB-9 Male	2.11	2.02	1.87
A12-25F-9F	DB-25 Female to DB-9 Female	2.11	2.02	1.87

D-SUB 25-PIN TO CENTRONICS 36-PIN ADAPTER



ORDER CODE	DESCRIPTION	1-24	25-49	50+
A13-25F-36M	DB-25 Female to Centronics 36-Pin Male	\$2.64	2.52	2.34
A13-25M-36F	DB-25 Male to Centronics 36-Pin Female	2.64	2.52	2.34

D-SUB 25 PIN NULL MODEM ADAPTER - MALE TO FEMALE

ORDER CODE	1-24	25-49	50+
A22-25-MF	\$3.52	3.36	3.12



USB VERSION 2.0 HI-SPEED CABLES

- Support data transfer rate up to 480 Mbps.
- Backward compatible with existing USB peripherals.
- Connectors: USB Type A, Type B, Mini B, and Micro B.



TYPE A MALE TO TYPE A FEMALE

ORDER CODE	LENGTH	1-24	25-49	50+
U08-AM-AF-06	6 feet	\$3.08	2.94	2.73
U08-AM-AF-10	10 feet	4.31	4.12	3.82
U08-AM-AF-15	15 feet	5.81	5.54	5.15



U08-AM-AF

USB VERSION 3.0 SUPER-SPEED CABLES

- Support data transfer rate up to 5.0 Gbit/s.
- USB 3.0 Type A receptacles are compatible with USB 2.0 device plugs for the respective physical form factors.



TYPE A MALE TO TYPE A MALE

ORDER CODE	LENGTH	1-24	25-49	50+
U08-AM-AM-03-3.0	3 feet	\$6.48	6.18	5.74
U08-AM-AM-06-3.0	6 feet	7.71	7.36	6.83
U08-AM-AM-10-3.0	10 feet	9.40	8.97	8.33
U08-AM-AM-15-3.0	15 feet	11.51	10.99	10.20



U08-AM-AM-XX-3.0

TYPE A MALE TO TYPE A MALE

ORDER CODE	LENGTH	1-24	25-49	50+
U08-AM-AM-03	3 feet	\$2.02	1.93	1.79
U08-AM-AM-06	6 feet	2.90	2.77	2.57
U08-AM-AM-10	10 feet	4.14	3.95	3.67
U08-AM-AM-15	15 feet	5.63	5.38	4.99



U08-AM-AM

TYPE A MALE TO TYPE B MALE

ORDER CODE	LENGTH	1-24	25-49	50+
U08-AM-BM-03-3.0	3 feet	\$6.67	6.37	5.91
U08-AM-BM-06-3.0	6 feet	7.94	7.58	7.04
U08-AM-BM-10-3.0	10 feet	9.68	9.24	8.58
U08-AM-BM-15-3.0	15 feet	11.86	11.32	10.51



U08-AM-BM-XX-3.0

TYPE A MALE TO TYPE B MALE

ORDER CODE	LENGTH	1-24	25-49	50+
U08-AM-BM-03	3 feet	\$2.38	2.27	2.11
U08-AM-BM-06	6 feet	3.34	3.19	2.96
U08-AM-BM-10	10 feet	4.49	4.28	3.98
U08-AM-BM-15	15 feet	6.07	5.80	5.38



U08-AM-BM

CONVERTERS & ADAPTERS

USB TO DB9 SERIAL ADAPTER CABLE, 3 FT.

ORDER CODE	1-24	25-49	50+
U04-DB9-03	\$31.68	30.24	28.08



U04-DB9-06

USB TO PS/2 (KEYBOARD + MOUSE) CABLE, 1 FOOT

ORDER CODE	1-24	25-49	50+
U04-PS2-01	\$17.60	16.80	15.60



U04-PS2-01

TYPE A MALE TO MINI B MALE

ORDER CODE	LENGTH	1-24	25-49	50+
U08-AM-MBM-03	3 feet	\$2.64	2.52	2.34
U08-AM-MBM-06	6 feet	3.17	3.02	2.81
U08-AM-MBM-10	10 feet	3.70	3.53	3.28
U08-AM-MBM-15	15 feet	4.58	4.37	4.06



U08-AM-MBM

SNAP-IN MODULE

USB TYPE A

- USB A to USB A Snap-in Module
- Dimension: 14.60mm x 16.00mm x 40.60mm
- Color (YY): White, Gray, Black, Blue, Green, Red, Orange, Yellow, Ivory

ORDER CODE	1-49	50-99	100+
071D-USBA-YY	\$2.20	2.10	1.95



071D-USBA-YY

USB TYPE B

- USB B to USB B Snap-in Module
- Dimension: 14.60mm x 16.00mm x 41.00mm
- Color (YY): White, Gray, Black, Blue, Green, Red, Orange, Yellow, Ivory

ORDER CODE	1-49	50-99	100+
071D-USBB-YY	\$2.20	2.10	1.95



071D-USBB-YY

TYPE A MALE TO MICRO B MALE

ORDER CODE	LENGTH	1-24	25-49	50+
U08-AM-MICROBM-03	3 feet	\$1.46	1.39	1.29
U08-AM-MICROBM-06	6 feet	2.01	1.92	1.78



U08-AM-MICROBM

USB UTP EXTENDER



R04-EXT-C5E-FP



R04-HUB-C5E-107

ORDER CODE	DESCRIPTION	1-49	50-99	100+
R04-EXT-C5E-FP	USB UTP Extender, 110 Faceplate 1 Set	\$40.00	38.75	37.50
R04-EXT-C5E-P	USB UTP Extender, Box Style 1 Set	40.00	38.75	37.50
R04-HUB-C5E-104A	USB Hub, 1 in 3 out local, 1 out remote	59.20	57.35	55.50
R04-HUB-C5E-104	USB Hub, 1 in local, 4 out remote	59.20	57.35	55.50
R04-HUB-C5E-107	USB Hub, 1 in 3 out local, 4 out remote	80.00	77.50	75.00

TYPE A MALE 90° TO TYPE B FEMALE

ORDER CODE	LENGTH	1-24	25-49	50+
U08-AM9-AF1-010	10 inches	\$1.67	1.60	1.48



U08-AM9-AF1

19" USB & FIREWIRE FEED-THRU PANELS

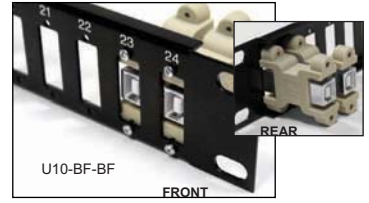
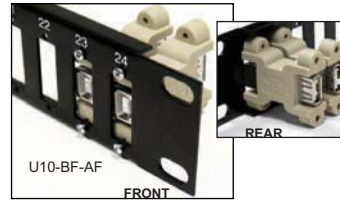
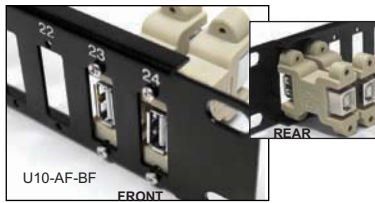
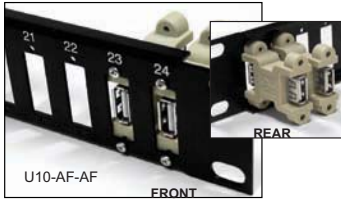

19" USB FEED-THRU PANELS

ORDER CODE	DESCRIPTION	1-9	10-19	20+
U10-AF-AF-12	12-Port USB Panel, A Female (Front) to A Female (Rear)	\$41.36	39.48	36.66
U10-AF-AF-16	16-Port USB Panel, A Female (Front) to A Female (Rear)	72.16	68.88	63.96
U10-AF-AF-24	24-Port USB Panel, A Female (Front) to A Female (Rear)	103.84	99.12	92.04
U10-AF-BF-12	12-Port USB Panel, A Female (Front) to B Female (Rear)	41.36	39.48	36.66
U10-AF-BF-16	16-Port USB Panel, A Female (Front) to B Female (Rear)	72.16	68.88	63.96
U10-AF-BF-24	24-Port USB Panel, A Female (Front) to B Female (Rear)	103.84	99.12	92.04
U10-BF-AF-12	12-Port USB Panel, B Female (Front) to A Female (Rear)	41.36	39.48	36.66
U10-BF-AF-16	16-Port USB Panel, B Female (Front) to A Female (Rear)	72.16	68.88	63.96
U10-BF-AF-24	24-Port USB Panel, B Female (Front) to A Female (Rear)	103.84	99.12	92.04
U10-BF-BF-12	12-Port USB Panel, B Female (Front) to B Female (Rear)	41.36	39.48	36.66
U10-BF-BF-16	16-Port USB Panel, B Female (Front) to B Female (Rear)	72.16	68.88	63.96
U10-BF-BF-24	24-Port USB Panel, B Female (Front) to B Female (Rear)	103.84	99.12	92.04

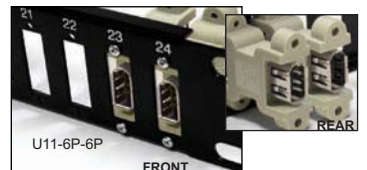
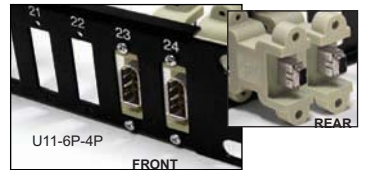
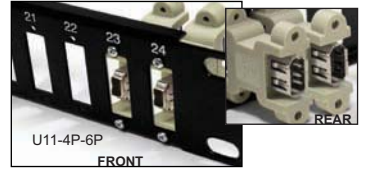
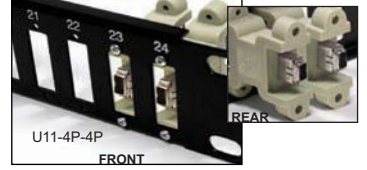

19" FIREWIRE FEED-THRU PANELS

ORDER CODE	DESCRIPTION	1-9	10-19	20+
U11-4P4P-12	12 Port FireWire Feed-Thru Panel, 4 Pin to 4 Pin	\$88.00	84.00	78.00
U11-4P4P-16	16 Port FireWire Feed-Thru Panel, 4 Pin to 4 Pin	114.40	109.20	101.40
U11-4P4P-24	24 Port FireWire Feed-Thru Panel, 4 Pin to 4 Pin	158.40	151.20	140.40
U11-4P6P-12	12 Port FireWire Feed-Thru Panel, 4 Pin (Front) to 6 Pin (Rear)	88.00	84.00	78.00
U11-4P6P-16	16 Port FireWire Feed-Thru Panel, 4 Pin (Front) to 6 Pin (Rear)	114.40	109.20	101.40
U11-4P6P-24	24 Port FireWire Feed-Thru Panel, 4 Pin (Front) to 6 Pin (Rear)	158.40	151.20	140.40
U11-6P4P-12	12 Port FireWire Feed-Thru Panel, 6 Pin (Front) to 4 Pin (Rear)	88.00	84.00	78.00
U11-6P4P-16	16 Port FireWire Feed-Thru Panel, 6 Pin (Front) to 4 Pin (Rear)	114.40	109.20	101.40
U11-6P4P-24	24 Port FireWire Feed-Thru Panel, 6 Pin (Front) to 4 Pin (Rear)	158.40	151.20	140.40
U11-6P6P-12	12 Port FireWire Feed-Thru Panel, 6 Pin (Front) to 6 Pin (Rear)	88.00	84.00	78.00
U11-6P6P-16	16 Port FireWire Feed-Thru Panel, 6 Pin (Front) to 6 Pin (Rear)	114.40	109.20	101.40
U11-6P6P-24	24 Port FireWire Feed-Thru Panel, 6 Pin (Front) to 6 Pin (Rear)	158.40	151.20	140.40

USB & FIREWIRE PANEL MOUNTABLE ADAPTERS

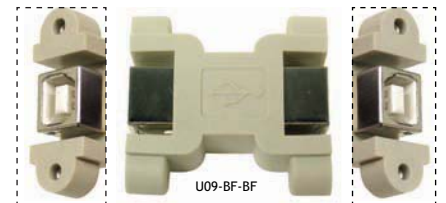

USB PANEL MOUNTABLE ADAPTERS

ORDER CODE	DESCRIPTION	1-24	25-49	50+
U09-AF-AF	USB Type A Female to Type A Female	\$2.64	2.52	2.34
U09-AF-BF	USB Type A Female to Type B Female	2.64	2.52	2.34
U09-BF-BF	USB Type B Female to Type B Female	2.64	2.52	2.34

FIREWIRE PANEL MOUNTABLE ADAPTERS

ORDER CODE	DESCRIPTION	1-24	25-49	50+
U12-4P4P	FireWire 4 Pin Female to 4 Pin Female	\$4.40	4.20	3.90
U12-6P4P	FireWire 6 Pin Female to 4 Pin Female	4.40	4.20	3.90
U12-6P6P	FireWire 6 Pin Female to 6 Pin Female	4.40	4.20	3.90



USB ADAPTERS



USB CONNECTOR GENDER CHANGER & ADAPTER

- PVC Injection Plastic Molding body.
- Type A or Type B, Male or Female connectors.

ORDER CODE	DESCRIPTION	1-24	25-49	50+
U05-AF-AF	Type A Female to Type A Female Adapter	\$1.67	1.60	1.48
U05-AF-BF	Type A Female to Type B Female Adapter	1.67	1.60	1.48
U05-AF-BM	Type A Female to Type B Male Adapter	1.67	1.60	1.48
U05-AM-AM	Type A Male to Type A Male Adapter	1.67	1.60	1.48
U05-AM-BF	Type A Male to Type B Female Adapter	1.67	1.60	1.48
U05-BF-BF	Type B Female to Type B Female Adapter	1.67	1.60	1.48
U05-BM-BM	Type B Male to Type B Male Adapter	1.67	1.60	1.48

- The CCTV Video Balun allows base-band composite video signals to be transmitted via an unshielded twisted pair (UTP) cable for more versatile cabling.
- Eliminate expensive coaxial cable, including coupling signals from remote video cameras to display systems, video capture, security and surveillance monitoring applications.
- Common Mode Rejection: Greater than 40dB at 8 MHz.
- Insertion Loss: Max. 2dB per pair over the frequency range from DC to 8 MHz.
- Return Loss: Greater than 15dB over the frequency range from DC to 8 MHz.
- Impedance: 75 Ohm to 100 Ohm.
- Maximum Input: 1.1 Vp-p.
- Bandwidth: Video DC to 8 MHz.



ORDER CODE	DESCRIPTION	1-24	25-49	50+
M01-BF-RJ45	Video Balun, BNC Female to RJ45 Jack, Snap-in Type	\$18.48	17.64	16.38
M01-FF-RJ45	Video Balun, F Connector Female to RJ45 Jack, Snap-in Type	18.48	17.64	16.38
M01-RF-RJ45	Video Balun, RCA Female to RJ45 Jack, Snap-in Type	19.36	18.48	17.16
M02-BM-RJ45	Video Balun, BNC Male to RJ45 Jack, Stand Alone Unit	17.60	16.80	15.60
M02-FM-RJ45	Video Balun, F Connector Male to RJ45 Jack, Stand Alone Unit	17.60	16.80	15.60
M02-RM-RJ45	Video Balun, RCA Male to RJ45 Jack, Stand Alone Unit	17.60	16.80	15.60
M03-BF-110	Video Balun, BNC Female to 110 Terminal	21.65	20.66	19.19
M03-BM-110	Video Balun, BNC Male to 110 Terminal	21.12	20.16	18.72
M03-FM-110	Video Balun, F Connector Male to 110 Terminal	17.60	16.80	15.60
M03-RM-110	Video Balun, RCA Male to 110 Terminal	17.60	16.80	15.60

VIDEO BALUN PATCH PANELS



ORDER CODE	DESCRIPTION	1-4	5-9	10+
M04-BF-RJ45-12	12-Port Video Balun Patch Panel, BNC Female (front) to RJ45 Jack (rear)	\$264.00	252.00	234.00
M04-BF-RJ45-16	16-Port Video Balun Patch Panel, BNC Female (front) to RJ45 Jack (rear)	334.40	319.20	296.40
M04-BF-RJ45-24	24-Port Video Balun Patch Panel, BNC Female (front) to RJ45 Jack (rear)	492.80	470.40	436.80
M04-RJ45-BF-12	12-Port Video Balun Patch Panel, RJ45 Jack (front) to BNC Female (rear)	264.00	252.00	234.00
M04-RJ45-BF-16	16-Port Video Balun Patch Panel, RJ45 Jack (front) to BNC Female (rear)	334.40	319.20	296.40
M04-RJ45-BF-24	24-Port Video Balun Patch Panel, RJ45 Jack (front) to BNC Female (rear)	492.80	470.40	436.80
M04-FF-RJ45-12	12-Port Video Balun Patch Panel, F Connector Female (front) to RJ45 Jack (rear)	264.00	252.00	234.00
M04-FF-RJ45-16	16-Port Video Balun Patch Panel, F Connector Female (front) to RJ45 Jack (rear)	334.40	319.20	296.40
M04-FF-RJ45-24	24-Port Video Balun Patch Panel, F Connector Female (front) to RJ45 Jack (rear)	492.80	470.40	436.80
M04-RJ45-FF-12	12-Port Video Balun Patch Panel, RJ45 Jack (front) to F Connector Female (rear)	264.00	252.00	234.00
M04-RJ45-FF-16	16-Port Video Balun Patch Panel, RJ45 Jack (front) to F Connector Female (rear)	334.40	319.20	296.40
M04-RJ45-FF-24	24-Port Video Balun Patch Panel, RJ45 Jack (front) to F Connector Female (rear)	492.80	470.40	436.80
M04-RF-RJ45-12	12-Port Video Balun Patch Panel, RCA Female (front) to RJ45 Jack (rear)	272.80	260.40	241.80
M04-RF-RJ45-16	16-Port Video Balun Patch Panel, RCA Female (front) to RJ45 Jack (rear)	352.00	336.00	312.00
M04-RF-RJ45-24	24-Port Video Balun Patch Panel, RCA Female (front) to RJ45 Jack (rear)	510.40	487.20	452.40
M04-RJ45-RF-12	12-Port Video Balun Patch Panel, RJ45 Jack (front) to RCA Female (rear)	272.80	260.40	241.80
M04-RJ45-RF-16	16-Port Video Balun Patch Panel, RJ45 Jack (front) to RCA Female (rear)	352.00	336.00	312.00
M04-RJ45-RF-24	24-Port Video Balun Patch Panel, RJ45 Jack (front) to RCA Female (rear)	510.40	487.20	452.40

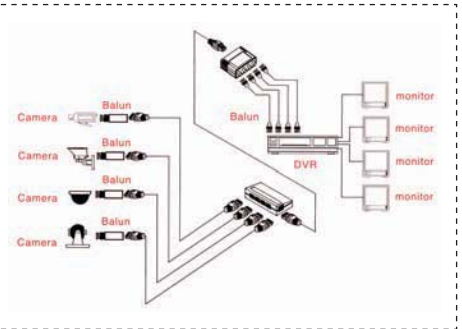









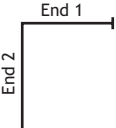

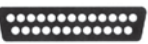



































AUDIO & VIDEO ADAPTERS



ORDER CODE	DESCRIPTION	1-49	50-99	100+
127-25SF-35SM	2.5mm Stereo Plug Female to 3.5mm Stereo Plug Male	\$1.97	1.88	1.75
127-35SF-35SF	3.5mm Stereo Plug Female to 3.5mm Stereo Plug Female	1.72	1.65	1.53
127-35SM-35SF2	3.5mm Stereo Plug Male to 2 3.5mm Stereo Plug Female	1.41	1.34	1.25
127-35SM-63SF	3.5mm Stereo Plug Male to 6.3mm Stereo Plug Female	1.72	1.65	1.53
127-35SM-RCAF2	3.5mm Stereo Plug Male to 2 RCA Female	1.41	1.34	1.25
127-63SM-35SF	6.3mm Stereo Plug Male to 3.5mm Stereo Plug Female	1.72	1.65	1.53
127-BNCF-FF	BNC Female to F Connector Female	1.41	1.34	1.25
127-BNCF-FM	BNC Female to F Connector Male, Push-On Type	1.76	1.68	1.56
127-BNCF-FM-T	BNC Female to F Connector Male, Screw On Type	1.76	1.68	1.56
127-BNCF-RCAM	BNC Female to RCA Male	1.76	1.68	1.56
127-BNCF-FF-T	BNC Male to F Connector Female, Screw On Type	1.76	1.68	1.56
127-BNCF-FM	BNC Male to F Connector Male	1.41	1.34	1.25
127-BNCF-RCAM	BNC Male to RCA Female	1.76	1.68	1.56
127-BNCF-RCAM	BNC Male to RCA Male	1.76	1.68	1.56
127-FF-35MM	F Connector Female to 3.5mm Mono Plug Male	1.41	1.34	1.25
127-FF-RCAF	F Connector Female to RCA Female	1.41	1.34	1.25
127-FF-RCAM	F Connector Female to RCA Male	1.41	1.34	1.25
127-FM-RCAF	F Connector Male to RCA Female	1.41	1.34	1.25
127-MD4F-MD4F	S-Video Mini Din 4 Female to Mini Din 4 Female	2.46	2.35	2.18
127-MD4F-RCAF	S-Video Mini Din 4 Female to RCA Female	3.70	3.53	3.28
127-MD4F-RCAM	S-Video Mini Din 4 Female to RCA Male	3.70	3.53	3.28
127-RCAF-35MM	RCA Female to 3.5mm Mono Plug Male	0.88	0.84	0.78
127-RCAF-RCAF	RCA Female to RCA Female	1.20	1.14	1.06
127-RCAF-RCAF2	RCA Female to 2 RCA Female	1.41	1.34	1.25
127-RCAM-RCAF2	RCA Male to 2 RCA Female	1.41	1.34	1.25



 <p>End 1 End 2</p>	 <p>Centronics 50 Male</p>	 <p>DB-25 Male</p>	 <p>Centronics 50 (micro) Male</p>	 <p>DB-50 (micro) Male</p>	 <p>DB-68 (micro) Male</p>	 <p>USD-68 (micro) Male</p>
 <p>Centronics 50 Male</p>	<p>SCSI 1: Centronics 50 • Double Shielded D01-C50-C50-1.5-T D01-C50-C50-03-T D01-C50-C50-06-T D01-C50-C50-10-T</p> 	<p>SCSI 1: Centronics 50 - DB25 • Double Shielded D01-C50-D25-1.5-T D01-C50-D25-03-T D01-C50-D25-06-T D01-C50-D25-10-T</p> 	<p>SCSI 2 to SCSI 1: Centronics 50 (micro) - Centronics 50 D07-SC50-C50-1.5 D07-SC50-C50-03 D07-SC50-C50-06 D07-SC50-C50-10</p> 	<p>SCSI 2 to SCSI 1: DB50 (micro) - Centronics 50 D06-SD50-C50-1.5 D06-SD50-C50-03 D06-SD50-C50-06 D06-SD50-C50-10</p> 	<p>SCSI 3 to SCSI 1: DB68 (micro) - Centronics 50 • Screw Type D08-SD68-C50-1.5-S D08-SD68-C50-03-S D08-SD68-C50-06-S D08-SD68-C50-10-S</p> 	<p>SCSI 3: USD68 (micro) - Centronics 50 (micro) • Screw Type D15-USD68-SC50-1.5 D15-USD68-SC50-03 D15-USD68-SC50-06 D15-USD68-SC50-10</p> 
 <p>DB-25 Male</p>	<p>SCSI 1: Centronics 50 - DB25 • Double Shielded D01-C50-D25-1.5-T D01-C50-D25-03-T D01-C50-D25-06-T D01-C50-D25-10-T</p> 	<p>SCSI 2 to SCSI 1: Centronics 50 (micro) - DB25 D06-SC50-D25-1.5 D06-SC50-D25-03 D06-SC50-D25-06 D06-SC50-D25-10</p> 	<p>SCSI 2 to SCSI 1: Centronics 50 (micro) - DB25 D06-SC50-D25-1.5 D06-SC50-D25-03 D06-SC50-D25-06 D06-SC50-D25-10</p> 	<p>SCSI 2 to SCSI 1: DB50 (micro) - DB25 D06-SD50-D25-1.5 D06-SD50-D25-03 D06-SD50-D25-06 D06-SD50-D25-10</p> 	<p>SCSI 3 to SCSI 1: DB68 (micro) - DB25 • Screw Type D08-SD68-D25-1.5-S D08-SD68-D25-03-S D08-SD68-D25-06-S D08-SD68-D25-10-S</p> 	<p>SCSI 3: USD68 (micro) - Centronics 50 (micro) • Screw Type D15-USD68-SC50-1.5 D15-USD68-SC50-03 D15-USD68-SC50-06 D15-USD68-SC50-10</p> 
 <p>Centronics 50 (micro) Male</p>	<p>SCSI 2 to SCSI 1: Centronics 50 (micro) - Centronics 50 D07-SC50-C50-1.5 D07-SC50-C50-03 D07-SC50-C50-06 D07-SC50-C50-10</p> 	<p>SCSI 2 to SCSI 1: Centronics 50 (micro) - DB25 D06-SC50-D25-1.5 D06-SC50-D25-03 D06-SC50-D25-06 D06-SC50-D25-10</p> 	<p>SCSI 2: Centronics 50 (micro) - Centronics 50 (micro) D06-SC50-SC50-1.5 D06-SC50-SC50-03 D06-SC50-SC50-06 D06-SC50-SC50-10</p> 	<p>SCSI 2: DB50 (micro) - Centronics 50 (micro) D06-SD50-SC50-1.5 D06-SD50-SC50-03 D06-SD50-SC50-06 D06-SD50-SC50-10</p> 	<p>SCSI 3 to SCSI 1: DB68 (micro) - Centronics 50 (micro) • Screw Type D08-SD68-SC50-1.5-S D08-SD68-SC50-03-S D08-SD68-SC50-06-S D08-SD68-SC50-10-S</p> 	<p>SCSI 3: USD68 (micro) - Centronics 50 (micro) • Screw Type D15-USD68-SC50-1.5 D15-USD68-SC50-03 D15-USD68-SC50-06 D15-USD68-SC50-10</p> 
 <p>DB-50 (micro) Male</p>	<p>SCSI 2 to SCSI 1: DB50 (micro) - Centronics 50 D06-SD50-C50-1.5 D06-SD50-C50-03 D06-SD50-C50-06 D06-SD50-C50-10</p> 	<p>SCSI 2 to SCSI 1: DB50 (micro) - DB25 D06-SD50-D25-1.5 D06-SD50-D25-03 D06-SD50-D25-06 D06-SD50-D25-10</p> 	<p>SCSI 2: DB50 (micro) - Centronics 50 (micro) D06-SD50-SC50-1.5 D06-SD50-SC50-03 D06-SD50-SC50-06 D06-SD50-SC50-10</p> 	<p>SCSI 2: DB50 (micro) - DB50 (micro) D06-SD50-SD50-1.5 D06-SD50-SD50-03 D06-SD50-SD50-06 D06-SD50-SD50-10</p> 	<p>SCSI 3 to SCSI 2: DB68 (micro) - DB50 (micro) • Screw Type D08-SD68-SD50-1.5-S D08-SD68-SD50-03-S D08-SD68-SD50-06-S D08-SD68-SD50-10-S</p> 	<p>SCSI 3 to SCSI 2: USD68 (micro) - DB50 (micro) • Screw Type D15-USD68-SD50-1.5 D15-USD68-SD50-03 D15-USD68-SD50-06 D15-USD68-SD50-10</p> 
 <p>DB-68 (micro) Male</p>	<p>SCSI 3 to SCSI 1: DB68 (micro) - Centronics 50 • Screw Type D08-SD68-C50-1.5-S D08-SD68-C50-03-S D08-SD68-C50-06-S D08-SD68-C50-10-S</p> 	<p>SCSI 3 to SCSI 1: DB68 (micro) - DB25 • Screw Type D08-SD68-D25-1.5-S D08-SD68-D25-03-S D08-SD68-D25-06-S D08-SD68-D25-10-S</p> 	<p>SCSI 3 to SCSI 1: DB68 (micro) - Centronics 50 (micro) • Screw Type D08-SD68-SC50-1.5-S D08-SD68-SC50-03-S D08-SD68-SC50-06-S D08-SD68-SC50-10-S</p> 	<p>SCSI 3 to SCSI 2: DB68 (micro) - DB50 (micro) • Screw Type D08-SD68-SD50-1.5-S D08-SD68-SD50-03-S D08-SD68-SD50-06-S D08-SD68-SD50-10-S</p> 	<p>SCSI 3: DB68 (micro) - DB68 (micro) • Screw Type D08-SD68-SD68-1.5-S D08-SD68-SD68-03-S D08-SD68-SD68-06-S D08-SD68-SD68-10-S</p> 	<p>SCSI 3: USD68 (micro) - DB68 (micro) • Screw Type D15-USD68-SD68-1.5 D15-USD68-SD68-03 D15-USD68-SD68-06 D15-USD68-SD68-10</p> 
 <p>USD-68 (micro) Male</p>	<p>Please check our website www.cablingsys.com or call us at 1-800-488-8821 for pricing.</p>		<p>SCSI 3: USD68 (micro) - Centronics 50 (micro) • Screw Type D15-USD68-SC50-1.5 D15-USD68-SC50-03 D15-USD68-SC50-06 D15-USD68-SC50-10</p> 	<p>SCSI 3 to SCSI 2: USD68 (micro) - DB50 (micro) • Screw Type D15-USD68-SD50-1.5 D15-USD68-SD50-03 D15-USD68-SD50-06 D15-USD68-SD50-10</p> 	<p>SCSI 3: USD68 (micro) - DB68 (micro) • Screw Type D15-USD68-SD68-1.5 D15-USD68-SD68-03 D15-USD68-SD68-06 D15-USD68-SD68-10</p> 	<p>SCSI 3: USD68 (micro) - USD68 (micro) • Screw Type D15-USD68-USD68-1.5 D15-USD68-USD68-03 D15-USD68-USD68-06 D15-USD68-USD68-10</p> 

CISCO OCTAL CABLE

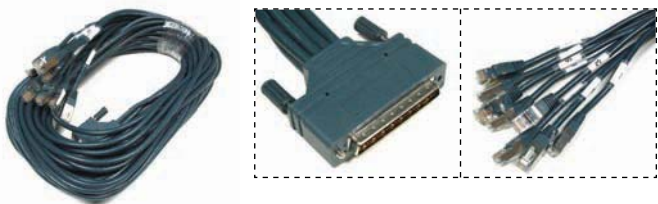

ORDER CODE	DESCRIPTION	1-24	25-49	50+
C20-OCTALASYNC10	HD68 Male to 8 RJ-45, 10 feet	\$49.28	47.04	43.68

10G BASE CX4 CABLE

10G BASE - CX4 CABLE

- 4x Infiniband Cable
- Latch Type



D25-CX4-XX

ORDER CODE	DESCRIPTION	1-24	25-49	50+
D25-CX4-0.5M	10G Base - CX4 Cable, 0.5 meter	\$67.58	64.51	59.90
D25-CX4-1M	10G Base - CX4 Cable, 1 meter	72.86	69.55	64.58
D25-CX4-3M	10G Base - CX4 Cable, 3 meters	95.04	90.72	84.24
D25-CX4-5M	10G Base - CX4 Cable, 5 meters	118.27	112.90	104.83

VHDCI SCSI CABLES/ADAPTERS

VHDCI SCSI CABLES

- Cable: 32 pairs 30 AWG, 2 pairs 28 AWG, Double Shielded, beige color.
- Connector 1: 0.8 mm, 68-Pin VHDCI SCSI-3 male with PVC molded hood, # 2-56 thumbscrews, beige.



- Designed for advanced SCSI multi-port applications.
- Up to four channels can be accommodated in one card slot.

ORDER CODE	DESCRIPTION	1-24	25-49	50+
D15-USD68-SD50-03	VHDCI-68M to SD-50M, 3 feet Cable	\$27.98	26.71	24.80
D15-USD68-SD50-06	VHDCI-68M to SD-50M, 6 feet Cable	38.19	36.46	33.85
D15-USD68-SD68-03	VHDCI-68M to SD-68M, 3 feet Cable	25.87	24.70	22.93
D15-USD68-SD68-06	VHDCI-68M to SD-68M, 6 feet Cable	35.02	33.43	31.04
D15-USD68-USD68-03	VHDCI-68M to VHDCI-68M, 3 feet Cable	32.56	31.08	28.86
D15-USD68-USD68-06	VHDCI-68M to VHDCI-68M, 6 feet Cable	41.71	39.82	36.97

OEM CABLES

- Quality products with fast turnaround.
- Years of industry experience and resources.
- Dependable Long-Term Service.
- For price quote, please provide specification / drawing of the cable that indicates cable types, length, jacket types, gender, connector types, and special instruction for each connector.



CISCO ROUTER CABLES

CISCO ROUTER CABLES - SMART SERIAL CABLES

- For Cisco 2600 series, smart serial WIC-2T Mini Port.
- Compatible with Cisco equipment.
- High Density construction.

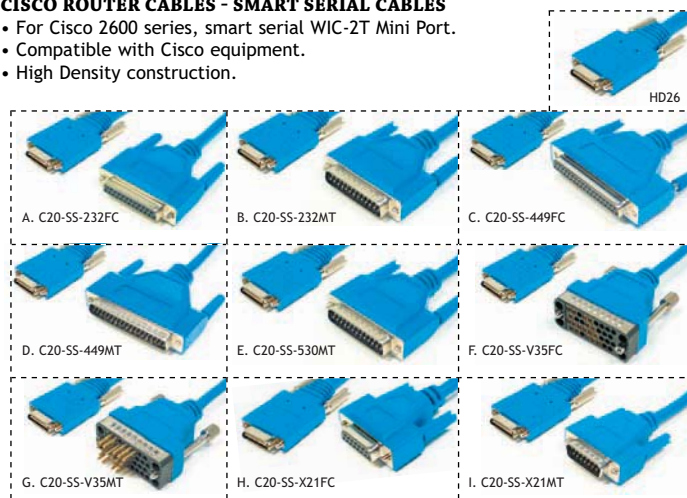

ORDER CODE	CISCO NO.	DESCRIPTION	1-9	10-19	20+
(A) C20-SS-232FC	CAB-SS-232FC	RS-232 cable, DCE, 10 feet High-Density 26M to DB-25F	\$24.64	23.52	21.84
(B) C20-SS-232MT	CAB-SS-232MT	RS-232 cable, DTE, 10 feet High-Density 26M to DB-25M	24.64	23.52	21.84
(C) C20-SS-449FC	CAB-SS-449FC	RS-449 cable, DCE, 10feet High-Density 26M to DB-37F	30.80	29.40	27.30
(D) C20-SS-449MT	CAB-SS-449MT	RS-449 cable, DTE, 10feet High-Density 26M to DB-37M	30.80	29.40	27.30
(E) C20-SS-530MT	CAB-SS-530MT	EIA-530 cable, DTE, 10feet High-Density 26M to DB-25M	30.80	29.40	27.30
(F) C20-SS-V35FC	CAB-SS-V35FC	V.35 cable, DCE, 10 feet High-Density 26M to V.35F	24.29	23.18	21.53
(G) C20-SS-V35MT	CAB-SS-V35MT	V.35 cable, DTE, 10 feet High-Density 26M to V.35M	24.64	23.52	21.84
(H) C20-SS-X21FC	CAB-SS-X21FC	X.21 Cable, DCE, 10 feet High-Density 26M to DB15F	24.64	23.52	21.84
(I) C20-SS-X21MT	CAB-SS-X21MT	X.21 Cable, DTE, 10 feet High-Density 26M to DB15M	24.64	23.52	21.84

- For Cisco 7000, 2500 and 4000NP-4T.
- Compatible with Cisco equipment.
- High Density construction.

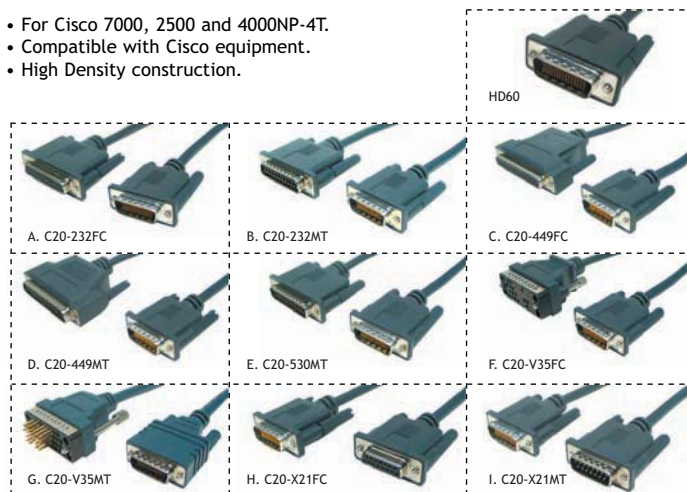

ORDER CODE	CISCO NO.	DESCRIPTION	1-9	10-19	20+
(A) C20-232FC	CAB-232FC	RS-232 cable, DCE, 10 feet High-Density DB60M to DB-25F	\$17.60	16.80	15.60
(B) C20-232MT	CAB-232MT	RS-232 cable, DTE, 10 feet High-Density DB60M to DB-25M	17.60	16.80	15.60
(C) C20-449FC	CAB-449FC	RS-449 cable, DCE, 10 feet High-Density DB60M to DB-37F	22.53	21.50	19.97
(D) C20-449MT	CAB-449MT	RS-449 cable, DTE, 10 feet High-Density B60M to DB-37M	22.53	21.50	19.97
(E) C20-530MT	CAB-530MT	EIA-530 cable, DTE, 10 feet High-Density DB60M to DB-25M	23.76	22.68	21.06
(F) C20-V35FC	CAB-V35FC	V.35 cable, DCE, 10 feet High-Density DB60M to V.35F	22.00	21.00	19.50
(G) C20-V35MT	CAB-V35MT	V.35 cable, DTE, 10 feet High-Density DB60M to V.35M	22.88	21.84	20.28
(H) C20-X21FC	CAB-X21FC	X.21 Cable, DCE, 10 feet High-Density DB60M to DB15F	17.60	16.80	15.60
(I) C20-X21MT	CAB-X21MT	X.21 Cable, DTE, 10 feet High-Density DB60M to DB15M	17.60	16.80	15.60



CABLING SYSTEM WAREHOUSE

Cabling System Warehouse
20418 E. Walnut Drive 1A
Diamond Bar, CA 91789
www.cablingsys.com
email:sales@cablingsys.com

800-488-8821
909-468-9211 • 909-468-9701 (fax)

PRESORTED
STANDARD
U.S. POSTAGE PAID
City of Industry, CA
PERMIT NO. 4421

Authorized Distributor

\$3.00